



RESULTS BOOK

OÖ LANDESMEISTERSCHAFT UND OÖ
MEISTERSCHAFT 2024

2024.04.13 - 2024.04.13

EUROPAPLATZ 5, 4663 LAAKIRCHEN

















AUSTRIA, AUT

TABLE OF CONTENTS

NUMBER OF ENTRIES	3
ENTRYLIST	4
ENRYLIST BY WEIGHT CATEGORY	14
STATISTICS	29
KATA INDIVIDUAL FEMALE SEN +35	31
KATA INDIVIDUAL FEMALE SENIORS	35
KATA INDIVIDUAL FEMALE U10	39
KATA INDIVIDUAL FEMALE U12	43
KATA INDIVIDUAL FEMALE U14	47
KATA INDIVIDUAL FEMALE U16	51
KATA INDIVIDUAL FEMALE U18	55
KATA INDIVIDUAL FEMALE U21	58
KATA INDIVIDUAL MALE SEN +45	65
KATA INDIVIDUAL MALE SEN+35	61
KATA INDIVIDUAL MALE SENIORS	69
KATA INDIVIDUAL MALE U10	73
KATA INDIVIDUAL MALE U12	77
KATA INDIVIDUAL MALE U14	81
KATA INDIVIDUAL MALE U16	85
KATA INDIVIDUAL MALE U21	89
KATA TEAM FEMALE SENIORS	93
KATA TEAM FEMALE U12	96
KATA TEAM FEMALE U16	99
KATA TEAM MALE U12	103
KATA TEAM MALE U21	106
KUMITE INDIVIDUAL FEMALE SENIORS +68	117
KUMITE INDIVIDUAL FEMALE SENIORS -68	120
KUMITE INDIVIDUAL FEMALE SENIORS 35+ OPEN	109
KUMITE INDIVIDUAL FEMALE U10	123

KUMITE INDIVIDUAL FEMALE U12.....	127
KUMITE INDIVIDUAL FEMALE U14.....	131
KUMITE INDIVIDUAL FEMALE U16 +54.....	134
KUMITE INDIVIDUAL FEMALE U16 -54.....	137
KUMITE INDIVIDUAL FEMALE U18 -53.....	140
KUMITE INDIVIDUAL MALE SENIORS +84.....	143
KUMITE INDIVIDUAL MALE SENIORS -67.....	147
KUMITE INDIVIDUAL MALE SENIORS -75.....	150
KUMITE INDIVIDUAL MALE SENIORS -84.....	153
KUMITE INDIVIDUAL MALE SENIORS 35+ OPEN.....	113
KUMITE INDIVIDUAL MALE U10.....	157
KUMITE INDIVIDUAL MALE U12.....	160
KUMITE INDIVIDUAL MALE U14.....	164
KUMITE INDIVIDUAL MALE U16 +70.....	168
KUMITE INDIVIDUAL MALE U16 -52.....	171
KUMITE INDIVIDUAL MALE U16 -57.....	174
KUMITE INDIVIDUAL MALE U16 -63.....	177
KUMITE INDIVIDUAL MALE U18 -76.....	180
KUMITE INDIVIDUAL MALE U21 OPEN.....	183
KUMITE TEAM FEMALE SEN.....	186
KUMITE TEAM MALE SEN.....	189
OFFICIAL RESULTS.....	192
MEDAL STANDING.....	203

Participation List (by Club/Team)

#	Code	Club	Male	Female	Total Entries	Total Athletes
1	 AUT	ASKÖ Karate Steyr(Steyr)	4	7	11	8
2	 AUT	ASKÖ Neuhofen Karate Seibukan(Karate SBK Neuhofen)	8	10	18	15
3	 AUT	ATSV Lenzing Sektion Karate(Lenzing)	16	4	20	10
4	 AUT	ATSV Seewalchen - Sektion Karate(Karate Seewalchen)	7	4	11	9
5	 AUT	Askö SeiBuKan Linz(SBK Linz)	45	40	85	45
6	 AUT	DSG Union Sankt Martin/Traun(DSG Union Traun)	6	2	8	6
7	 AUT	Karatedo Wels(Wels)	12	6	18	15
8	 AUT	LZ Oberösterreich(LZOÖ)	3	0	3	2
9	 AUT	Shin Tai Karate Vöcklabruck(Shin Tai Karate Vöcklabruck)	20	38	58	27
10	 AUT	Shotokan Karate Sportunion Altmünster(SPUA)	9	6	15	12
11	 AUT	Sportunion Attergau(Attergau)	15	1	16	10
12	 AUT	Sportunion Karate Gampern(Gampern)	1	1	2	2
13	 AUT	Sportunion Karate Gmunden(Gm)	7	7	14	8
14	 AUT	Sportunion Schwanenstadt(Schw)	10	12	22	18
15	 AUT	Sportverein Karate-do Marchtrenk(Karate-do Marchtrenk)	3	16	19	14
16	 AUT	Union Karateclub Grieskirchen(UKC Grieskirchen)	4	5	9	8
17	 AUT	shindo ASKÖ Linz Auhof(shindo)	2	0	2	1
Totals:			172	159	331	210



OÖ Landesmeisterschaft und OÖ Meisterschaft 2024

AUSTRIA
Europaplatz 5, 4663 Laakirchen

2024.04.13 - 2024.04.13

ENTRY LIST BY CLUB

AUSTRIA

ASKÖ Karate Steyr(Steyr)

ID	Sex	Family Name	Given Name	Category
1	Male	Beck	sebastian	Kumite Individual male U14
2	Female	Blümelhuber	Bianca	Kumite Individual female Seniors +68
3	Female	Blümelhuber	Bianca	Kata Individual female Seniors
4	Female	Göbelhaider	Stephanie	Kata Individual female U16
5	Female	Göbelhaider	Stephanie	Kumite Individual female U16 +54
6	Male	Kapeller	Moritz	Kumite Individual male U14
7	Female	Quatember	Luise	Kumite Individual female U18 -59
8	Female	Turanovic	Lejla	Kumite Individual female U16 -54
9	Female	Wojtak	Carina Tess	Kata Individual female Sen +35
10	Male	Yanardag	Ferdi	Kumite Individual Male Seniors 35+ Open
11	Male	Yanardag	Ferdi	Kumite Individual male Seniors +84

Entries: 11

ASKÖ Neuhofen Karate Seibukan(Karate SBK Neuhofen)

ID	Sex	Family Name	Given Name	Category
12	Male	de Souza - Frühwirt	Bernardo	Kata Individual male U10
13	Female	Dinstl	Linda	Kata Individual female U16
14	Female	Dinstl	Linda	Kumite Individual female U16 -54
15	Male	Hankowetz	Jakob	Kumite Individual male U16 -52
16	Male	Haslhofer	Mario	Kumite Individual male Seniors +84
17	Male	Huber	Niclas	Kumite Individual male U12
18	Female	Kauch	Franziska	Kata Individual female U12
19	Female	Lamm	Clara	Kata Individual female U16
20	Female	Mares	Miriam	Kata Individual female U10
21	Male	Reichl	Finn	Kata Individual male U10
22	Male	Reichl	Finn	Kumite Individual male U10
23	Female	Salzmann	Ida	Kata Individual female U12
24	Female	Salzmann	Ida	Kumite Individual female U12
25	Female	Schwarz	Antonella	Kumite Individual female U12
26	Female	Stockhammer	Miriam	Kumite Individual female U18 +59
27	Female	Wahl	Sarah	Kata Individual female U14
28	Male	Wintersperger	Lorenz	Kumite Individual male U18 -76
29	Male	Wurm	Matthias	Kata Individual male U10

Entries: 18

Askö SeiBuKan Linz(SBK Linz)

ID	Sex	Family Name	Given Name	Category
30	Male	Ackerbauer	Andreas	Kata Team male U21
31	Male	Ackerbauer	Andreas	Kumite Team male U16
32	Male	Ackerbauer	Andreas	Kata Individual male U16
33	Male	Ackerbauer	Andreas	Kumite Individual male U16 -52
34	Female	Ackerbauer	Sabine	Kumite Individual Female Seniors 35+ Open
35	Female	Ackerbauer	Sabine	Kata Individual female Sen +35



OÖ Landesmeisterschaft und OÖ Meisterschaft 2024

AUSTRIA
Europaplatz 5, 4663 Laakirchen

2024.04.13 - 2024.04.13

ENTRY LIST BY CLUB

Askö SeiBuKan Linz(SBK Linz)					
ID	Sex	Family Name	Given Name	Category	
36	Female	Ackerbauer	Sabine	Kumite Team female Sen	
37	Female	Ausserwöger	Corina	Kata Individual female Sen +35	
38	Female	Ausserwöger	Corina	Kumite Team female Sen	
39	Female	Ausserwöger	Corina	Kumite Individual Female Seniors 35+ Open	
40	Male	Bachlmayr	Michael	Kumite Individual male Seniors -75	
41	Male	Bachlmayr	Michael	Kumite Individual Male Seniors 35+ Open	
42	Male	Bachlmayr	Michael	Kata Individual male Sen+35	
43	Male	Bachlmayr	Michael	Kumite Team male Sen	
44	Male	Bachlmayr	Michael	Kata Individual male Sen +45	
45	Male	Beganovic	Sanid	Kumite Individual male U16 +70	
46	Female	Berisha	Natalie	Kata Team female Seniors	
47	Female	Berisha	Natalie	Kumite Individual female Seniors +68	
48	Female	Berisha	Natalie	Kata Individual female Seniors	
49	Female	Berisha	Natalie	Kumite Team female Sen	
50	Male	Böheim	Martin	Kumite Team male Sen	
51	Female	Causevic	Melek Eiwa	Kata Individual female U10	
52	Female	Causevic	Melek Eiwa	Kata Team female U12	
53	Male	Chen	Chenkai	Kata Individual male U12	
54	Male	Chen	Chenkai	Kata Team male U12	
55	Male	Chen	Chenkai	Kumite Individual male U12	
56	Male	Dukic	Amra	Kata Individual male U10	
57	Male	FEILMAYR	RAPHAEL	Kumite Individual male Seniors -84	
58	Male	FEILMAYR	RAPHAEL	Kumite Team male Sen	
59	Male	FORTNER	NIKLAS	Kumite Individual male U18 -76	
60	Male	FORTNER	NIKLAS	Kata Individual male U21	
61	Female	Fuchs	Anna	Kata Individual female Seniors	
62	Female	Fuchs	Anna	Kumite Team female Sen	
63	Female	Fuchs	Anna	Kata Team female Seniors	
64	Female	Fuchs	Anna	Kumite Individual female Seniors -68	
65	Male	Gaderer	Julian	Kata Individual male U14	
66	Male	Gaderer	Julian	Kata Team male U21	
67	Male	Gaderer	Julian	Kumite Individual male U14	
68	Male	Galateanu	David	Kata Individual male U16	
69	Male	Galateanu	David	Kata Team male U21	
70	Male	Galateanu	David	Kumite Individual male U16 -57	
71	Male	Galateanu	David	Kumite Team male U16	
72	Female	Galateanu	Evelyn	Kumite Individual female U18 -53	
73	Female	Galateanu	Evelyn	Kata Individual female U18	
74	Female	Galateanu	Evelyn	Kata Individual female Seniors	
75	Male	Hagleitner	Oliver	Kumite Team male Sen	
76	Male	Heinisch	Leon	Kata Team male U12	
77	Male	Heinisch	Leon	Kumite Individual male U12	
78	Male	Heinisch	Leon	Kata Individual male U12	
79	Male	Herac	Elvedin	Kumite Team male Sen	
80	Male	Herac	Elvedin	Kumite Individual male Seniors +84	
81	Male	Huskic	Denis	Kumite Individual male Seniors -67	
82	Male	Huskic	Denis	Kumite Team male Sen	



OÖ Landesmeisterschaft und OÖ Meisterschaft 2024

AUSTRIA
Europaplatz 5, 4663 Laakirchen

2024.04.13 - 2024.04.13

ENTRY LIST BY CLUB

Askö SeiBuKan Linz(SBK Linz)					
ID	Sex	Family Name	Given Name	Category	
83	Male	Huskic	Denis	Kumite Individual male U21 Open	
84	Male	Huskic	Denis	Kata Individual male U21	
85	Female	Huskic	Diana	Kata Team female U12	
86	Female	Huskic	Diana	Kata Individual female U12	
87	Female	Huskic	Diana	Kumite Individual female U12	
88	Female	Ikic	Vanessa	Kumite Team female Sen	
89	Female	Islamovic	Ajla	Kumite Individual female U18 -53	
90	Female	Islamovic	Ajla	Kata Individual female U18	
91	Female	Islamovic	Emira	Kumite Individual female U12	
92	Female	Islamovic	Emira	Kata Team female U12	
93	Female	Islamovic	Emira	Kata Individual female U12	
94	Female	Krammel	Verena	Kata Individual female U12	
95	Female	Krammel	Verena	Kumite Individual female U12	
96	Male	Ladstätter	Alexander	Kumite Team male Sen	
97	Male	Mahmic	Isam	Kata Individual male U10	
98	Male	Markovic	Andrej	Kumite Individual male U10	
99	Male	Markovic	Andrej	Kata Team male U12	
100	Male	Markovic	Andrej	Kata Individual male U10	
101	Male	Mayr	Werner	Kata Team male U21	
102	Male	Mayr	Werner	Kumite Team male U16	
103	Male	Mayr	Werner	Kata Individual male U16	
104	Male	Mayr	Werner	Kumite Individual male U16 +70	
105	Female	Mitri	Jennifer	Kumite Individual female U12	
106	Female	Mitri	Jennifer	Kata Team female U12	
107	Female	Mitri	Jennifer	Kata Individual female U12	
108	Female	Mörixbauer	Leila	Kata Team female U12	
109	Female	NOORI	LENIA	Kata Individual female U10	
110	Female	NOORI	LENIA	Kumite Individual female U10	
111	Female	NOORI	LENIA	Kata Team female U12	
112	Female	Pointner	Lisa	Kumite Individual female Seniors -68	
113	Female	Pointner	Lisa	Kumite Team female Sen	
114	Male	Reinsprecht	Stephan	Kumite Individual Male Seniors 35+ Open	
115	Male	Reinsprecht	Stephan	Kumite Individual male Seniors -84	
116	Male	Reinsprecht	Stephan	Kata Individual male Sen+35	
117	Male	Reinsprecht	Stephan	Kumite Team male Sen	
118	Male	Reinsprecht	Stephan	Kata Individual male Sen +45	
119	Female	Schlögl	Andrea	Kumite Team female Sen	
120	Female	Schlögl	Andrea	Kumite Individual Female Seniors 35+ Open	
121	Female	Schlögl	Andrea	Kata Individual female Sen +35	
122	Female	Schlögl	Andrea	Kata Individual female Sen +45	
123	Female	Schober	Elisabeth	Kata Individual female U12	
124	Male	Sedeqy	Josef	Kumite Individual male U14	
125	Male	Sedeqy	Josef	Kata Team male U21	
126	Male	Sedeqy	Josef	Kata Individual male U14	
127	Female	Steininger	Charlotte	Kata Individual female U12	
128	Female	Steininger	Charlotte	Kumite Individual female U12	
129	AUT2025	Female	Sticht	Patricia	Kata Team female Seniors



OÖ Landesmeisterschaft und OÖ Meisterschaft 2024

AUSTRIA
Europaplatz 5, 4663 Laakirchen

2024.04.13 - 2024.04.13

ENTRY LIST BY CLUB

Askö SeiBuKan Linz(SBK Linz)					
ID	Sex	Family Name	Given Name	Category	
130	AUT2025	Female	Sticht	Patricia	Kumite Individual female Seniors +68
131	AUT2025	Female	Sticht	Patricia	Kata Individual female Seniors
132	AUT2025	Female	Sticht	Patricia	Kumite Team female Sen
133		Male	Stieger	Jakob	Kumite Individual male U14
134		Female	Tran	Leonie	Kumite Individual female U10
135		Female	Tran	Leonie	Kata Team female U12
136		Female	Tran	Leonie	Kata Individual female U10
137		Male	Tran	Tommy	Kata Team male U21
138		Male	Tran	Tommy	Kata Individual male U14
139		Male	Uzunkaya	Semih	Kumite Individual male U16 -57
140		Male	Wiesinger	Markus	Kumite Individual male Seniors -67
141		Male	Wiesinger	Markus	Kumite Team male Sen
142		Male	Wiesinger	Markus	Kumite Individual Male Seniors 35+ Open
143		Female	Öllinger	Anna	Kumite Team female Sen

Entries: 114

ATSV Lenzing Sektion Karate(Lenzing)					
ID	Sex	Family Name	Given Name	Category	
144		Male	Eggl	Johannes	Kumite Individual male U21 Open
145		Male	Eggl	Johannes	Kata Individual male U21
146		Male	Eggl	Johannes	Kumite Individual male Seniors +84
147		Male	Eggl	Johannes	Kata Team male U21
148		Male	Eggl	Johannes	Kata Individual male Seniors
149		Male	Hosseini	Saro	Kata Individual male U16
150		Male	Hosseini	Saro	Kumite Individual male U16 +70
151		Male	Hosseini	Saro	Kata Team male U21
152		Male	Nagel	Raphael	Kata Individual male Seniors
153		Male	Nagel	Raphael	Kumite Individual male U21 Open
154		Male	Nagel	Raphael	Kata Individual male U21
155		Male	Nagel	Raphael	Kumite Individual male Seniors +84
156		Male	Nagel	Raphael	Kata Team male U21
157		Female	Neudorfer	Ella	Kata Team female U12
158		Female	Neudorfer	Ella	Kata Individual female U12
159		Male	Odobasic	Haris	Kata Team male U12
160		Male	Odobasic	Haris	Kata Individual male U10
161		Female	Roither	Mia	Kata Individual female U10
162		Female	Roither	Mia	Kata Team female U12
163		Male	Roither	Michael	Kata Team male U12
164		Male	Roither	Michael	Kata Individual male U10
165		Male	Schachinger	Tim	Kata Individual male U16
166		Male	Schmid	Moritz	Kata Individual male U12
167		Male	Schmid	Moritz	Kata Team male U12
168		Female	Seebauer	Franziska	Kata Individual female U10
169		Female	Seebauer	Franziska	Kata Team female U12

Entries: 26



OÖ Landesmeisterschaft und OÖ Meisterschaft 2024

AUSTRIA
Europaplatz 5, 4663 Laakirchen

2024.04.13 - 2024.04.13

ENTRY LIST BY CLUB

ATSV Seewalchen - Sektion Karate(Karate Seewalchen)					
ID	Sex	Family Name	Given Name	Category	
170	Female	Ablinger	Birgit	Kata Team female Seniors	
171	Female	Ablinger	Sarah	Kata Individual female U16	
172	Female	Ablinger	Sarah	Kumite Individual female U16 -54	
173	Male	Bogad	Patrick	Kata Individual male U16	
174	Male	Bogad	Patrick	Kumite Individual male U16 -63	
175	Male	Demic-Bachmair	Samy	Kumite Individual male U12	
176	Female	Kopacka-Riedl	Kim	Kata Team female Seniors	
177	Female	Riedl	Lilia	Kata Individual female U10	
178	Male	Voghuber	Alexander	Kata Individual male U16	
179	Male	Voghuber	Alexander	Kumite Individual male U16 -52	
180	Male	Wienerroither	Lukas	Kumite Individual male U16 -57	
181	Male	Wienerroither	Lukas	Kata Individual male U16	
182	Female	Zeilberger	Elke	Kata Team female Seniors	

Entries: 13

DSG Union Sankt Martin/Traun(DSG Union Traun)					
ID	Sex	Family Name	Given Name	Category	
183	Male	Bihorac	Muhamed	Kumite Individual male U12	
184	Male	Burger	Diego	Kumite Individual male U14	
185	Male	Burger	Diego	Kata Individual male U14	
186	Male	Kadic	Davud	Kumite Individual male U14	
187	Male	Tijanovic	Adin	Kumite Individual male U12	
188	Female	Wendler	Mia Desirée	Kata Individual female U12	
189	Female	Wendler	Mia Desirée	Kumite Individual female U12	
190	Male	Zec	Danis	Kumite Individual male U10	

Entries: 8

Karatedo Wels(Wels)					
ID	Sex	Family Name	Given Name	Category	
191	Female	Duric	Delissa	Kata Individual female U14	
192	Female	Eberl	Marlene	Kata Individual female U16	
193	Male	Hasanovic	Tarik	Kata Individual male U12	
194	Male	Hönig	Leon	Kata Individual male U10	
195	Male	Hüttmeir	Tobias	Kumite Individual male Seniors -84	
196	Male	Ikanovic	Tarik	Kata Individual male U16	
197	Female	Kanuric	Elena	Kata Individual female U12	
198	Male	Pantelic	Dusan	Kata Individual male U16	
199	Female	Popova	Varvara	Kata Individual female Seniors	
200	Male	Reichardt	Simon	Kata Individual male U12	
201	Male	Rieger	Julian	Kata Individual male U10	
202	Male	Sakanovic	Adin	Kata Individual male U16	
203	Male	Sakanovic	Adin	Kumite Individual male U16 -63	
204	Female	Sakanovic	Adna	Kata Individual female U16	
205	Female	Sakanovic	Adna	Kumite Individual female U16 -54	
206	Male	Salaji	Argjent	Kata Individual male Seniors	
207	Male	Salaji	Argjent	Kata Individual male U21	



OÖ Landesmeisterschaft und OÖ Meisterschaft 2024

AUSTRIA
Europaplatz 5, 4663 Laakirchen

2024.04.13 - 2024.04.13

ENTRY LIST BY CLUB

Karatedo Wels(Wels)					
ID	Sex	Family Name	Given Name	Category	
208	Male	Sunje	Adriano	Kata Individual male U12	

Entries: 18

LZ Oberösterreich(LZOÖ)					
ID	Sex	Family Name	Given Name	Category	
209	Male	CHEBAN	Oleksandr	Kumite Individual male U16 -63	
210	Male	Grigorasenco	Nichita	Kumite Individual male U21 Open	
211	Male	Grigorasenco	Nichita	Kumite Individual male Seniors -75	

Entries: 3

Shin Tai Karate Vöcklabruck(Shin Tai Karate Vöcklabruck)					
ID	Sex	Family Name	Given Name	Category	
212	Female	Bekas	Aryana	Kata Individual female U10	
213	Female	Bekas	Aryana	Kumite Individual female U10	
214	Female	Bekas	Aryana	Kata Team female U12	
215	Male	Großhaupt	Erik	Kumite Team male Sen	
216	Female	Grudke	Linda	Kata Individual female Seniors	
217	Female	Grudke	Linda	Kumite Individual female U18 -53	
218	Female	Grudke	Linda	Kata Individual female U18	
219	Female	Günther	Mia	Kata Individual female U14	
220	Female	Günther	Mia	Kumite Individual female U14	
221	Female	Günther	Mia	Kata Team female U16	
222	Female	Hackl	Lieselotte	Kata Individual female U10	
223	Female	Hackl	Lieselotte	Kumite Individual female U10	
224	Female	Hackl	Lieselotte	Kata Team female U12	
225	Male	Hemetsberger	Maximilian	Kata Team male U12	
226	Male	Hemetsberger	Maximilian	Kata Individual male U10	
227	Male	Hemetsberger	Maximilian	Kumite Individual male U10	
228	Female	Hitsch	Sophie	Kumite Individual female U16 +54	
229	Female	Hitsch	Sophie	Kata Individual female U16	
230	Male	Holzinger	Alexander	Kata Individual male U16	
231	Male	Holzinger	Alexander	Kumite Individual male U16 -52	
232	Female	Jonas	Sarah	Kumite Team female Sen	
233	Female	Jonas	Sarah	Kumite Individual female U21 -55	
234	Female	Jonas	Sarah	Kata Individual female U21	
235	Female	Jonas	Sarah	Kata Team female Seniors	
236	Female	Jonas	Sarah	Kumite Individual female Seniors -68	
237	Female	Jonas	Sarah	Kata Individual female Seniors	
238	Female	Jung	Lena	Kata Individual female U14	
239	Female	Jung	Lena	Kumite Individual female U14	
240	Female	Jung	Lena	Kata Team female U16	
241	Female	Jung	Michaela	Kumite Individual Female Seniors 35+ Open	
242	Female	Jung	Michaela	Kata Team female Seniors	
243	Female	Jung	Michaela	Kata Individual female Sen +35	
244	Female	Jung	Michaela	Kumite Team female Sen	
245	Male	Klinglmayr	Günther	Kumite Team male Sen	



OÖ Landesmeisterschaft und OÖ Meisterschaft 2024

AUSTRIA
Europaplatz 5, 4663 Laakirchen

2024.04.13 - 2024.04.13

ENTRY LIST BY CLUB

Shin Tai Karate Vöcklabruck(Shin Tai Karate Vöcklabruck)					
ID	Sex	Family Name	Given Name	Category	
246	Male	Klinglmayr	Günther	Kumite Individual male Seniors -75	
247	Male	Klinglmayr	Günther	Kumite Individual Male Seniors 35+ Open	
248	Male	Krawczyk	Dawid	Kumite Individual male U18 -76	
249	Female	Lichtenthal	Magdalena	Kumite Individual female U12	
250	Female	Lichtenthal	Magdalena	Kata Team female U12	
251	Female	Lichtenthal	Magdalena	Kata Individual female U12	
252	Male	Nagl	Gregor	Kumite Individual male Seniors -75	
253	Male	Nagl	Gregor	Kumite Team male Sen	
254	Male	Nagl	Gregor	Kata Individual male Seniors	
255	Female	Pehlic	Alisa	Kata Team female U12	
256	Female	Pehlic	Alisa	Kata Individual female U12	
257	Female	Pehlic	Alisa	Kumite Individual female U12	
258	Male	Riedler	Jonas	Kumite Individual male U14	
259	Male	Riedler	Jonas	Kata Individual male U14	
260	Female	Schell	Carina	Kumite Team female Sen	
261	Female	Schell	Carina	Kumite Individual Female Seniors 35+ Open	
262	Female	Schell	Carina	Kata Team female Seniors	
263	Female	Schell	Carina	Kata Individual female Sen +35	
264	Female	Schell	Sophia	Kata Individual female U10	
265	Female	Schell	Sophia	Kumite Individual female U10	
266	Female	Schell	Sophia	Kata Team female U12	
267	Male	Schell	Thomas	Kumite Individual Male Seniors 35+ Open	
268	Male	Schell	Thomas	Kumite Team male Sen	
269	Female	Skenderovic	Leona	Kata Individual female U10	
270	Female	Skenderovic	Leona	Kumite Individual female U10	
271	Female	Skenderovic	Leona	Kata Team female U12	
272	Male	Stroblmayr	Samuel	Kata Individual male U12	
273	Male	Stroblmayr	Samuel	Kata Team male U12	
274	Male	Stroblmayr	Samuel	Kumite Individual male U12	
275	Female	Weinberger	Pia	Kumite Individual female U16 +54	
276	Female	Weinberger	Pia	Kata Team female U16	
277	Female	Weinberger	Pia	Kata Individual female U16	
278	Male	Weinberger	Stefan	Kumite Individual male Seniors +84	
279	Male	Weinberger	Stefan	Kumite Team male Sen	
280	Male	Wimmer	Jonas	Kumite Individual male U12	
281	Male	Wimmer	Jonas	Kata Individual male U12	
282	Male	Wimmer	Jonas	Kata Team male U12	
283	Female	Winkler	Alina	Kata Individual female U16	
284	Female	Winkler	Alina	Kumite Individual female U16 +54	
285	Male	Zhao	Junxi	Kumite Individual male U12	

Entries: 74

shindo ASKÖ Linz Auhof(shindo)					
ID	Sex	Family Name	Given Name	Category	
286	Male	Mala Hamza	Hem	Kata Individual male U12	
287	Male	Mala Hamza	Hem	Kumite Individual male U12	



OÖ Landesmeisterschaft und OÖ Meisterschaft 2024

AUSTRIA
Europaplatz 5, 4663 Laakirchen

2024.04.13 - 2024.04.13

ENTRY LIST BY CLUB

Entries: 2

 Shotokan Karate Sportunion Altmünster(SPUA)					
ID	Sex	Family Name	Given Name	Category	
288	Male	Dickinger	Christian	Kata Individual male Sen+35	
289	Male	Dickinger	Christian	Kata Individual male Sen +45	
290	Male	Dickinger	Leonhard	Kata Individual male U12	
291	Male	Gehmaier	Sebastian	Kata Individual male U14	
292	Female	Hüttner	Viktoria	Kata Team female U16	
293	Female	Hüttner	Viktoria	Kata Individual female U14	
294	Female	Janecek	Elina	Kata Individual female U14	
295	Female	Janecek	Elina	Kata Team female U16	
296	Male	Leitner	Alexander	Kata Individual male U14	
297	Female	Mittendorfer	Christina	Kata Team female U16	
298	Female	Mittendorfer	Christina	Kata Individual female U14	
299	Male	Mittendorfer	Mathias	Kata Individual male U14	
300	Female	Tremel	Anna	Kata Individual female U18	
301	Female	Tremel	Anna	Kata Individual female Seniors	
302	Male	Zellinger	Leon	Kata Individual male U16	
303	Male	Zierler	Richard	Kata Individual male U10	
304	Male	Öhlinger	Moritz	Kata Individual male U12	

Entries: 17

 Sportunion Attergau(Attergau)					
ID	Sex	Family Name	Given Name	Category	
305	Male	Hemetsberger	Oskar	Kata Individual male Seniors	
306	Male	Hemetsberger	Oskar	Kata Individual male Sen +45	
307	Male	Hemetsberger	Oskar	Kata Individual male Sen+35	
308	Male	Hittenberger	Christopher Martin	Kata Individual male U14	
309	Male	Hittenberger	Christopher Martin	Kumite Individual male U14	
310	Male	Klausberger	Vincent Nikolaus	Kata Individual male U14	
311	Male	Krinninger	Paul	Kata Individual male U12	
312	Male	Mehmedagic	Amir	Kata Individual male Sen+35	
313	Male	Mehmedagic	Amir	Kata Individual male Seniors	
314	Male	Mehmedagic	Anes	Kata Individual male U12	
315	Female	Mehmedagic	Hana	Kata Individual female U14	
316	Male	Schachl	Moritz	Kata Individual male U14	
317	Male	Schachl	Niklas	Kata Individual male Seniors	
318	Male	Schachl	Niklas	Kata Individual male U21	
319	Male	Schulz	Ralph Martin	Kata Individual male Sen+35	
320	Male	Schulz	Ralph Martin	Kata Individual male Seniors	

Entries: 16

 Sportunion Karate Gampern(Gampern)					
ID	Sex	Family Name	Given Name	Category	
321	Male	Aschenberger	Raphael	Kata Individual male U12	
322	Female	Aschenberger	Sophia	Kata Individual female U14	

Entries: 2



OÖ Landesmeisterschaft und OÖ Meisterschaft 2024

AUSTRIA
Europaplatz 5, 4663 Laakirchen

2024.04.13 - 2024.04.13

ENTRY LIST BY CLUB

Sportunion Karate Gmunden(Gm)					
ID	Sex	Family Name	Given Name	Category	
323	Female	Aichstill	Desiree	Kata Team female Seniors	
324	Female	Aichstill	Desiree	Kata Individual female Seniors	
325	Female	Feichtinger	Veronika	Kata Individual female U21	
326	Female	Feichtinger	Veronika	Kata Individual female Seniors	
327	Female	Grill	Melanie	Kata Team female Seniors	
328	Female	Grill	Melanie	Kata Individual female Seniors	
329	Male	Großhaupt	Erik	Kata Individual male Seniors	
330	Male	Großhaupt	Erik	Kumite Individual male Seniors -67	
331	Male	Großhaupt	Ludwig	Kata Individual male Sen+35	
332	Male	Großhaupt	Ludwig	Kata Individual male Seniors	
333	Male	Großhaupt	Ludwig	Kata Individual male Sen +45	
334	Female	Hauser	Sophie	Kata Individual female U16	
335	Female	Obereigner	Anja	Kata Individual female U21	
336	Female	Obereigner	Anja	Kata Team female Seniors	
337	Male	Thaler	Dominik	Kumite Individual male U12	
338	Male	Thaler	Dominik	Kata Individual male U12	

Entries: 16

Sportunion Schwanenstadt(Schw)					
ID	Sex	Family Name	Given Name	Category	
339	Male	Cenanovic	Leon	Kumite Individual male U14	
340	Male	Cenanovic	Leon	Kata Individual male U14	
341	Male	Fellner	Franz	Kata Individual male U10	
342	Female	Grill	Amelie	Kumite Individual female U10	
343	Female	Grill	Amelie	Kata Individual female U10	
344	Female	Grochar	Frida	Kata Individual female U12	
345	Female	Hajdarevic	Anida	Kata Individual female U12	
346	Male	Hiljuk	Felix	Kata Individual male U10	
347	Female	Hiljuk	Helena	Kata Individual female U10	
348	Female	Huber	Jessica	Kata Individual female U14	
349	Female	Jukic	Emina	Kata Individual female U14	
350	Male	Jungwirth	Moritz	Kata Individual male U12	
351	Female	Kastenhuber	Julia	Kata Individual female U12	
352	Female	Mujanovic	Emina	Kata Individual female U12	
353	Male	Mujanovic	Hamza	Kata Individual male U16	
354	Female	Mujanovic	Lamija	Kata Individual female U12	
355	Female	Osmic	Rihana	Kata Individual female U12	
356	Female	Osmic	Sarah	Kata Individual female U14	
357	Male	Vlacic	Aleksandar	Kumite Individual male Seniors -84	
358	Male	Vlacic	Aleksandar	Kata Individual male Seniors	
359	Male	Vlacic	Stefan	Kata Individual male Seniors	
360	Male	Vlacic	Stefan	Kumite Individual male Seniors -84	

Entries: 22

Sportverein Karate-do Marchtrenk(Karate-do Marchtrenk)					
ID	Sex	Family Name	Given Name	Category	



OÖ Landesmeisterschaft und OÖ Meisterschaft 2024

AUSTRIA
Europaplatz 5, 4663 Laakirchen

2024.04.13 - 2024.04.13

ENTRY LIST BY CLUB

 Sportverein Karate-do Marchtrenk(Karate-do Marchtrenk)					
ID	Sex	Family Name	Given Name	Category	
361	Male	Andic	Antonio	Kata Individual male U10	
362	Female	Begovic	Aneli	Kata Individual female U14	
363	Female	Begovic	Nadija	Kata Team female U16	
364	Female	Begovic	Nadija	Kata Individual female U16	
365	Female	Covic	Saura	Kata Individual female U14	
366	Female	Covic	Saura	Kumite Individual female U14	
367	Female	Covic	Saura	Kata Team female U16	
368	Male	Herac	Edvin	Kata Individual male Seniors	
369	Female	Husidic	Dajra	Kata Individual female U14	
370	Female	Husidic	Dajra	Kumite Individual female U14	
371	Female	Jelica	Gabriela	Kata Individual female U14	
372	Female	Jelica	Gabriela	Kata Team female U16	
373	Female	Königsdorfer	Miriam	Kata Individual female U10	
374	Female	Macanovic	Ema	Kata Individual female U10	
375	Female	Macanovic	Majda	Kata Individual female Sen +35	
376	Female	Macanovic	Majda	Kata Individual female Seniors	
377	Female	Memic	Hana	Kata Team female U16	
378	Female	Memic	Hana	Kata Individual female U16	
379	Male	Trumic	Ahmed	Kata Individual male U14	
380	Female	Trumic	Amina	Kata Individual female U14	
381	Female	Trumic	Amina	Kata Team female U16	
382	Female	Trumic	Sumeja	Kata Team female U16	
383	Female	Trumic	Sumeja	Kata Individual female U16	

Entries: 23

 Union Karateclub Grieskirchen(UKC Grieskirchen)					
ID	Sex	Family Name	Given Name	Category	
384	Male	Flattinger	Ben	Kata Team male U12	
385	Male	Flattinger	Ben	Kata Individual male U10	
386	Male	Flattinger	Clemens	Kata Individual male U14	
387	Female	Hinterberger	Amelie	Kata Individual female U12	
388	Female	Hinterberger	Mia	Kata Individual female U12	
389	Female	Hinterberger	Mia	Kata Team female U16	
390	Female	Huber	Sophia-Marie	Kata Team female U16	
391	Female	Huber	Sophia-Marie	Kata Individual female U16	
392	Female	Hörmandinger	Elina	Kata Team female U16	
393	Female	Hörmandinger	Elina	Kata Individual female U16	
394	Male	Mühlbauer	Alexander	Kata Team male U12	
395	Male	Schindler	Laurenz	Kata Individual male U10	
396	Male	Schindler	Laurenz	Kata Team male U12	

Entries: 13

Total Entries:396

ENTRY LIST

Kata Individual female Sen +35				
CODE	Sex	Family Name	Given Name	Club / Team / NOC
AUT	Female	Ackerbauer	Sabine	Askö SeiBuKan Linz(SBK Linz)
AUT	Female	Ausserwöger	Corina	Askö SeiBuKan Linz(SBK Linz)
AUT	Female	Jung	Michaela	Shin Tai Karate Vöcklabruck(Shin Tai Karate Vöcklabruck)
AUT	Female	Macanovic	Majda	Sportverein Karate-do Marchtrenk(Karate-do Marchtrenk)
AUT	Female	Schell	Carina	Shin Tai Karate Vöcklabruck(Shin Tai Karate Vöcklabruck)
AUT	Female	Schlögl	Andrea	Askö SeiBuKan Linz(SBK Linz)
AUT	Female	Wojtak	Carina Tess	ASKÖ Karate Steyr(Steyr)

Entries: 7

Kata Individual female Sen +45				
CODE	Sex	Family Name	Given Name	Club / Team / NOC
AUT	Female	Schlögl	Andrea	Askö SeiBuKan Linz(SBK Linz)

Entries: 1

Kata Individual female Seniors				
CODE	Sex	Family Name	Given Name	Club / Team / NOC
AUT	Female	Aichstill	Desiree	Sportunion Karate Gmunden(Gm)
AUT	Female	Berisha	Natalie	Askö SeiBuKan Linz(SBK Linz)
AUT	Female	Blümelhuber	Bianca	ASKÖ Karate Steyr(Steyr)
AUT	Female	Feichtinger	Veronika	Sportunion Karate Gmunden(Gm)
AUT	Female	Fuchs	Anna	Askö SeiBuKan Linz(SBK Linz)
AUT	Female	Galateanu	Evelyn	Askö SeiBuKan Linz(SBK Linz)
AUT	Female	Grill	Melanie	Sportunion Karate Gmunden(Gm)
AUT	Female	Grudke	Linda	Shin Tai Karate Vöcklabruck(Shin Tai Karate Vöcklabruck)
AUT	Female	Jonas	Sarah	Shin Tai Karate Vöcklabruck(Shin Tai Karate Vöcklabruck)
AUT	Female	Macanovic	Majda	Sportverein Karate-do Marchtrenk(Karate-do Marchtrenk)
AUT	Female	Popova	Varvara	Karatedo Wels(Wels)
AUT	Female	Sticht	Patricia	Askö SeiBuKan Linz(SBK Linz)
AUT	Female	Treml	Anna	Shotokan Karate Sportunion Altmünster(SPUA)

Entries: 13

Kata Individual female U10				
CODE	Sex	Family Name	Given Name	Club / Team / NOC
AUT	Female	Bekas	Aryana	Shin Tai Karate Vöcklabruck(Shin Tai Karate Vöcklabruck)
AUT	Female	Causevic	Melek Eiwa	Askö SeiBuKan Linz(SBK Linz)
AUT	Female	Grill	Amelie	Sportunion Schwanenstadt(Schw)
AUT	Female	Hackl	Lieselotte	Shin Tai Karate Vöcklabruck(Shin Tai Karate Vöcklabruck)
AUT	Female	Hiljuk	Helena	Sportunion Schwanenstadt(Schw)
AUT	Female	Königsdorfer	Miriam	Sportverein Karate-do Marchtrenk(Karate-do Marchtrenk)
AUT	Female	Macanovic	Ema	Sportverein Karate-do Marchtrenk(Karate-do Marchtrenk)

ENTRY LIST

Kata Individual female U10

CODE	Sex	Family Name	Given Name	Club / Team / NOC
AUT	Female	Mares	Miriam	ASKÖ Neuhofen Karate Seibukan(Karate SBK Neuhofen)
AUT	Female	NOORI	LENIA	Askö SeiBuKan Linz(SBK Linz)
AUT	Female	Riedl	Lilia	ATSV Seewalchen - Sektion Karate(Karate Seewalchen)
AUT	Female	Roither	Mia	ATSV Lenzing Sektion Karate(Lenzing)
AUT	Female	Schell	Sophia	Shin Tai Karate Vöcklabruck(Shin Tai Karate Vöcklabruck)
AUT	Female	Seebauer	Franziska	ATSV Lenzing Sektion Karate(Lenzing)
AUT	Female	Skenderovic	Leona	Shin Tai Karate Vöcklabruck(Shin Tai Karate Vöcklabruck)
AUT	Female	Tran	Leonie	Askö SeiBuKan Linz(SBK Linz)

Entries: 15

Kata Individual female U12

CODE	Sex	Family Name	Given Name	Club / Team / NOC
AUT	Female	Grochar	Frida	Sportunion Schwanenstadt(Schw)
AUT	Female	Hajdarevic	Anida	Sportunion Schwanenstadt(Schw)
AUT	Female	Hinterberger	Amelie	Union Karateclub Grieskirchen(UKC Grieskirchen)
AUT	Female	Hinterberger	Mia	Union Karateclub Grieskirchen(UKC Grieskirchen)
AUT	Female	Huskic	Diana	Askö SeiBuKan Linz(SBK Linz)
AUT	Female	Islamovic	Emira	Askö SeiBuKan Linz(SBK Linz)
AUT	Female	Kanuric	Elena	Karatedo Wels(Wels)
AUT	Female	Kastenhuber	Julia	Sportunion Schwanenstadt(Schw)
AUT	Female	Kauch	Franziska	ASKÖ Neuhofen Karate Seibukan(Karate SBK Neuhofen)
AUT	Female	Krammel	Verena	Askö SeiBuKan Linz(SBK Linz)
AUT	Female	Lichtenthal	Magdalena	Shin Tai Karate Vöcklabruck(Shin Tai Karate Vöcklabruck)
AUT	Female	Mitri	Jennifer	Askö SeiBuKan Linz(SBK Linz)
AUT	Female	Mujanovic	Emina	Sportunion Schwanenstadt(Schw)
AUT	Female	Mujanovic	Lamija	Sportunion Schwanenstadt(Schw)
AUT	Female	Neudorfer	Ella	ATSV Lenzing Sektion Karate(Lenzing)
AUT	Female	Osmic	Rihana	Sportunion Schwanenstadt(Schw)
AUT	Female	Pehlic	Alisa	Shin Tai Karate Vöcklabruck(Shin Tai Karate Vöcklabruck)
AUT	Female	Salzmann	Ida	ASKÖ Neuhofen Karate Seibukan(Karate SBK Neuhofen)
AUT	Female	Schober	Elisabeth	Askö SeiBuKan Linz(SBK Linz)
AUT	Female	Steininger	Charlotte	Askö SeiBuKan Linz(SBK Linz)
AUT	Female	Wendler	Mia Desireé	DSG Union Sankt Martin/Traun(DSG Union Traun)

Entries: 21

Kata Individual female U14

CODE	Sex	Family Name	Given Name	Club / Team / NOC
AUT	Female	Aschenberger	Sophia	Sportunion Karate Gampern(Gampern)
AUT	Female	Begovic	Aneli	Sportverein Karate-do Marchtrenk(Karate-do Marchtrenk)
AUT	Female	Covic	Saura	Sportverein Karate-do Marchtrenk(Karate-do Marchtrenk)

ENTRY LIST

Kata Individual female U14				
CODE	Sex	Family Name	Given Name	Club / Team / NOC
AUT	Female	Duric	Delissa	Karatedo Wels(Wels)
AUT	Female	Günther	Mia	Shin Tai Karate Vöcklabruck(Shin Tai Karate Vöcklabruck)
AUT	Female	Huber	Jessica	Sportunion Schwanenstadt(Schw)
AUT	Female	Husidic	Dajra	Sportverein Karate-do Marchtrenk(Karate-do Marchtrenk)
AUT	Female	Hüttner	Viktoria	Shotokan Karate Sportunion Altmünster(SPUA)
AUT	Female	Janecek	Elina	Shotokan Karate Sportunion Altmünster(SPUA)
AUT	Female	Jelica	Gabriela	Sportverein Karate-do Marchtrenk(Karate-do Marchtrenk)
AUT	Female	Jukic	Emina	Sportunion Schwanenstadt(Schw)
AUT	Female	Jung	Lena	Shin Tai Karate Vöcklabruck(Shin Tai Karate Vöcklabruck)
AUT	Female	Mehmedagic	Hana	Sportunion Attergau(Attergau)
AUT	Female	Mittendorfer	Christina	Shotokan Karate Sportunion Altmünster(SPUA)
AUT	Female	Osmic	Sarah	Sportunion Schwanenstadt(Schw)
AUT	Female	Trumic	Amina	Sportverein Karate-do Marchtrenk(Karate-do Marchtrenk)
AUT	Female	Wahl	Sarah	ASKÖ Neuhofen Karate Seibukan(Karate SBK Neuhofen)

Entries: 17

Kata Individual female U16				
CODE	Sex	Family Name	Given Name	Club / Team / NOC
AUT	Female	Ablinger	Sarah	ATSV Seewalchen - Sektion Karate(Karate Seewalchen)
AUT	Female	Begovic	Nadija	Sportverein Karate-do Marchtrenk(Karate-do Marchtrenk)
AUT	Female	Dinstl	Linda	ASKÖ Neuhofen Karate Seibukan(Karate SBK Neuhofen)
AUT	Female	Eberl	Marlene	Karatedo Wels(Wels)
AUT	Female	Göbelhaider	Stephanie	ASKÖ Karate Steyr(Steyr)
AUT	Female	Hauser	Sophie	Sportunion Karate Gmunden(Gm)
AUT	Female	Hitsch	Sophie	Shin Tai Karate Vöcklabruck(Shin Tai Karate Vöcklabruck)
AUT	Female	Huber	Sophia-Marie	Union Karateclub Grieskirchen(UKC Grieskirchen)
AUT	Female	Hörmandinger	Elina	Union Karateclub Grieskirchen(UKC Grieskirchen)
AUT	Female	Lamm	Clara	ASKÖ Neuhofen Karate Seibukan(Karate SBK Neuhofen)
AUT	Female	Memic	Hana	Sportverein Karate-do Marchtrenk(Karate-do Marchtrenk)
AUT	Female	Sakanovic	Adna	Karatedo Wels(Wels)
AUT	Female	Trumic	Sumeja	Sportverein Karate-do Marchtrenk(Karate-do Marchtrenk)
AUT	Female	Weinberger	Pia	Shin Tai Karate Vöcklabruck(Shin Tai Karate Vöcklabruck)
AUT	Female	Winkler	Alina	Shin Tai Karate Vöcklabruck(Shin Tai Karate Vöcklabruck)

Entries: 15

Kata Individual female U18				
CODE	Sex	Family Name	Given Name	Club / Team / NOC

ENTRY LIST

Kata Individual female U18

CODE	Sex	Family Name	Given Name	Club / Team / NOC
AUT	Female	Galateanu	Evelyn	Askö SeiBuKan Linz(SBK Linz)
AUT	Female	Grudke	Linda	Shin Tai Karate Vöcklabruck(Shin Tai Karate Vöcklabruck)
AUT	Female	Islamovic	Ajla	Askö SeiBuKan Linz(SBK Linz)
AUT	Female	Tremel	Anna	Shotokan Karate Sportunion Altmünster(SPUA)

Entries: 4

Kata Individual female U21

CODE	Sex	Family Name	Given Name	Club / Team / NOC
AUT	Female	Feichtinger	Veronika	Sportunion Karate Gmunden(Gm)
AUT	Female	Jonas	Sarah	Shin Tai Karate Vöcklabruck(Shin Tai Karate Vöcklabruck)
AUT	Female	Obereigner	Anja	Sportunion Karate Gmunden(Gm)

Entries: 3

Kata Individual male Sen +45

CODE	Sex	Family Name	Given Name	Club / Team / NOC
AUT	Male	Bachlmayr	Michael	Askö SeiBuKan Linz(SBK Linz)
AUT	Male	Dickinger	Christian	Shotokan Karate Sportunion Altmünster(SPUA)
AUT	Male	Großhaupt	Ludwig	Sportunion Karate Gmunden(Gm)
AUT	Male	Hemetsberger	Oskar	Sportunion Attergau(Attergau)
AUT	Male	Reinsprecht	Stephan	Askö SeiBuKan Linz(SBK Linz)

Entries: 5

Kata Individual male Sen+35

CODE	Sex	Family Name	Given Name	Club / Team / NOC
AUT	Male	Bachlmayr	Michael	Askö SeiBuKan Linz(SBK Linz)
AUT	Male	Dickinger	Christian	Shotokan Karate Sportunion Altmünster(SPUA)
AUT	Male	Großhaupt	Ludwig	Sportunion Karate Gmunden(Gm)
AUT	Male	Hemetsberger	Oskar	Sportunion Attergau(Attergau)
AUT	Male	Mehmedagic	Amir	Sportunion Attergau(Attergau)
AUT	Male	Reinsprecht	Stephan	Askö SeiBuKan Linz(SBK Linz)
AUT	Male	Schulz	Ralph Martin	Sportunion Attergau(Attergau)

Entries: 7

Kata Individual male Seniors

CODE	Sex	Family Name	Given Name	Club / Team / NOC
AUT	Male	Eggl	Johannes	ATSV Lenzing Sektion Karate(Lenzing)
AUT	Male	Großhaupt	Erik	Sportunion Karate Gmunden(Gm)
AUT	Male	Großhaupt	Ludwig	Sportunion Karate Gmunden(Gm)
AUT	Male	Hemetsberger	Oskar	Sportunion Attergau(Attergau)
AUT	Male	Herac	Edvin	Sportverein Karate-do Marchtrenk(Karate-do Marchtrenk)
AUT	Male	Mehmedagic	Amir	Sportunion Attergau(Attergau)
AUT	Male	Nagel	Raphael	ATSV Lenzing Sektion Karate(Lenzing)
AUT	Male	Nagl	Gregor	Shin Tai Karate Vöcklabruck(Shin Tai Karate Vöcklabruck)
AUT	Male	Salaji	Argjent	Karatedo Wels(Wels)

ENTRY LIST

Kata Individual male Seniors

CODE	Sex	Family Name	Given Name	Club / Team / NOC
AUT	Male	Schachl	Niklas	Sportunion Attergau(Attergau)
AUT	Male	Schulz	Ralph Martin	Sportunion Attergau(Attergau)
AUT	Male	Vlacic	Aleksandar	Sportunion Schwanenstadt(Schw)
AUT	Male	Vlacic	Stefan	Sportunion Schwanenstadt(Schw)

Entries: 13

Kata Individual male U10

CODE	Sex	Family Name	Given Name	Club / Team / NOC
AUT	Male	Andic	Antonio	Sportverein Karate-do Marchtrenk(Karate-do Marchtrenk)
AUT	Male	de Souza - Frühwirt	Bernardo	ASKÖ Neuhofen Karate Seibukan(Karate SBK Neuhofen)
AUT	Male	Dukic	Amra	Askö SeiBuKan Linz(SBK Linz)
AUT	Male	Fellner	Franz	Sportunion Schwanenstadt(Schw)
AUT	Male	Flattinger	Ben	Union Karateclub Grieskirchen(UKC Grieskirchen)
AUT	Male	Hemetsberger	Maximilian	Shin Tai Karate Vöcklabruck(Shin Tai Karate Vöcklabruck)
AUT	Male	Hiljuk	Felix	Sportunion Schwanenstadt(Schw)
AUT	Male	Hönig	Leon	Karatedo Wels(Wels)
AUT	Male	Mahmic	Isam	Askö SeiBuKan Linz(SBK Linz)
AUT	Male	Markovic	Andrej	Askö SeiBuKan Linz(SBK Linz)
AUT	Male	Odobasic	Haris	ATSV Lenzing Sektion Karate(Lenzing)
AUT	Male	Reichl	Finn	ASKÖ Neuhofen Karate Seibukan(Karate SBK Neuhofen)
AUT	Male	Rieger	Julian	Karatedo Wels(Wels)
AUT	Male	Roither	Michael	ATSV Lenzing Sektion Karate(Lenzing)
AUT	Male	Schindler	Laurenz	Union Karateclub Grieskirchen(UKC Grieskirchen)
AUT	Male	Wurm	Matthias	ASKÖ Neuhofen Karate Seibukan(Karate SBK Neuhofen)
AUT	Male	Zierler	Richard	Shotokan Karate Sportunion Altmünster(SPUA)

Entries: 17

Kata Individual male U12

CODE	Sex	Family Name	Given Name	Club / Team / NOC
AUT	Male	Aschenberger	Raphael	Sportunion Karate Gampern(Gampern)
AUT	Male	Chen	Chenkai	Askö SeiBuKan Linz(SBK Linz)
AUT	Male	Dickinger	Leonhard	Shotokan Karate Sportunion Altmünster(SPUA)
AUT	Male	Hasanovic	Tarik	Karatedo Wels(Wels)
AUT	Male	Heinisch	Leon	Askö SeiBuKan Linz(SBK Linz)
AUT	Male	Jungwirth	Moritz	Sportunion Schwanenstadt(Schw)
AUT	Male	Krinninger	Paul	Sportunion Attergau(Attergau)
AUT	Male	Mala Hamza	Hem	shindo ASKÖ Linz Auhof(shindo)
AUT	Male	Mehmedagic	Anes	Sportunion Attergau(Attergau)
AUT	Male	Reichardt	Simon	Karatedo Wels(Wels)
AUT	Male	Schmid	Moritz	ATSV Lenzing Sektion Karate(Lenzing)
AUT	Male	Stroblmayr	Samuel	Shin Tai Karate Vöcklabruck(Shin Tai Karate Vöcklabruck)
AUT	Male	Sunje	Adriano	Karatedo Wels(Wels)
AUT	Male	Thaler	Dominik	Sportunion Karate Gmunden(Gm)

ENTRY LIST

Kata Individual male U12				
CODE	Sex	Family Name	Given Name	Club / Team / NOC
AUT	Male	Wimmer	Jonas	Shin Tai Karate Vöcklabruck(Shin Tai Karate Vöcklabruck)
AUT	Male	Öhlinger	Moritz	Shotokan Karate Sportunion Altmünster(SPUA)

Entries: **16**

Kata Individual male U14				
CODE	Sex	Family Name	Given Name	Club / Team / NOC
AUT	Male	Burger	Diego	DSG Union Sankt Martin/Traun(DSG Union Traun)
AUT	Male	Cenanovic	Leon	Sportunion Schwanenstadt(Schw)
AUT	Male	Flattinger	Clemens	Union Karateclub Grieskirchen(UKC Grieskirchen)
AUT	Male	Gaderer	Julian	Askö SeiBuKan Linz(SBK Linz)
AUT	Male	Gehmaier	Sebastian	Shotokan Karate Sportunion Altmünster(SPUA)
AUT	Male	Hittenberger	Christopher Martin	Sportunion Attergau(Attergau)
AUT	Male	Klausberger	Vincent Nikolaus	Sportunion Attergau(Attergau)
AUT	Male	Leitner	Alexander	Shotokan Karate Sportunion Altmünster(SPUA)
AUT	Male	Mittendorfer	Mathias	Shotokan Karate Sportunion Altmünster(SPUA)
AUT	Male	Riedler	Jonas	Shin Tai Karate Vöcklabruck(Shin Tai Karate Vöcklabruck)
AUT	Male	Schachl	Moritz	Sportunion Attergau(Attergau)
AUT	Male	Sedeqy	Josef	Askö SeiBuKan Linz(SBK Linz)
AUT	Male	Tran	Tommy	Askö SeiBuKan Linz(SBK Linz)
AUT	Male	Trumic	Ahmed	Sportverein Karate-do Marchtrenk(Karate-do Marchtrenk)

Entries: **14**

Kata Individual male U16				
CODE	Sex	Family Name	Given Name	Club / Team / NOC
AUT	Male	Ackerbauer	Andreas	Askö SeiBuKan Linz(SBK Linz)
AUT	Male	Bogad	Patrick	ATSV Seewalchen - Sektion Karate(Karate Seewalchen)
AUT	Male	Galateanu	David	Askö SeiBuKan Linz(SBK Linz)
AUT	Male	Holzinger	Alexander	Shin Tai Karate Vöcklabruck(Shin Tai Karate Vöcklabruck)
AUT	Male	Hosseini	Saro	ATSV Lenzing Sektion Karate(Lenzing)
AUT	Male	Ikanovic	Tarik	Karatedo Wels(Wels)
AUT	Male	Mayr	Werner	Askö SeiBuKan Linz(SBK Linz)
AUT	Male	Mujanovic	Hamza	Sportunion Schwanenstadt(Schw)
AUT	Male	Pantelic	Dusan	Karatedo Wels(Wels)
AUT	Male	Sakanovic	Adin	Karatedo Wels(Wels)
AUT	Male	Schachinger	Tim	ATSV Lenzing Sektion Karate(Lenzing)
AUT	Male	Voglhuber	Alexander	ATSV Seewalchen - Sektion Karate(Karate Seewalchen)
AUT	Male	Wienerroither	Lukas	ATSV Seewalchen - Sektion Karate(Karate Seewalchen)
AUT	Male	Zellinger	Leon	Shotokan Karate Sportunion Altmünster(SPUA)

Entries: **14**

Kata Individual male U21				
CODE	Sex	Family Name	Given Name	Club / Team / NOC

ENTRY LIST

Kata Individual male U21				
CODE	Sex	Family Name	Given Name	Club / Team / NOC
AUT	Male	Eggl	Johannes	ATSV Lenzing Sektion Karate(Lenzing)
AUT	Male	FORTNER	NIKLAS	Askö SeiBuKan Linz(SBK Linz)
AUT	Male	Huskic	Denis	Askö SeiBuKan Linz(SBK Linz)
AUT	Male	Nagel	Raphael	ATSV Lenzing Sektion Karate(Lenzing)
AUT	Male	Salaji	Argjent	Karatedo Wels(Wels)
AUT	Male	Schachl	Niklas	Sportunion Attergau(Attergau)

Entries: 6

Kata Team female Seniors				
CODE	Sex	Family Name	Given Name	Club / Team / NOC
AUT	Female	Ablinger	Birgit	ATSV Seewalchen - Sektion Karate(Karate Seewalchen)
AUT	Female	Aichstill	Desiree	Sportunion Karate Gmunden(Gm)
AUT	Female	Berisha	Natalie	Askö SeiBuKan Linz(SBK Linz)
AUT	Female	Fuchs	Anna	Askö SeiBuKan Linz(SBK Linz)
AUT	Female	Grill	Melanie	Sportunion Karate Gmunden(Gm)
AUT	Female	Jonas	Sarah	Shin Tai Karate Vöcklabruck(Shin Tai Karate Vöcklabruck)
AUT	Female	Jung	Michaela	Shin Tai Karate Vöcklabruck(Shin Tai Karate Vöcklabruck)
AUT	Female	Kopacka-Riedl	Kim	ATSV Seewalchen - Sektion Karate(Karate Seewalchen)
AUT	Female	Obereigner	Anja	Sportunion Karate Gmunden(Gm)
AUT	Female	Schell	Carina	Shin Tai Karate Vöcklabruck(Shin Tai Karate Vöcklabruck)
AUT	Female	Sticht	Patricia	Askö SeiBuKan Linz(SBK Linz)
AUT	Female	Zeilberger	Elke	ATSV Seewalchen - Sektion Karate(Karate Seewalchen)

Entries: 12

Kata Team female U12				
CODE	Sex	Family Name	Given Name	Club / Team / NOC
AUT	Female	Bekas	Aryana	Shin Tai Karate Vöcklabruck(Shin Tai Karate Vöcklabruck)
AUT	Female	Causevic	Melek Eiwa	Askö SeiBuKan Linz(SBK Linz)
AUT	Female	Hackl	Lieselotte	Shin Tai Karate Vöcklabruck(Shin Tai Karate Vöcklabruck)
AUT	Female	Huskic	Diana	Askö SeiBuKan Linz(SBK Linz)
AUT	Female	Islamovic	Emira	Askö SeiBuKan Linz(SBK Linz)
AUT	Female	Lichtenthal	Magdalena	Shin Tai Karate Vöcklabruck(Shin Tai Karate Vöcklabruck)
AUT	Female	Mitri	Jennifer	Askö SeiBuKan Linz(SBK Linz)
AUT	Female	Mörixbauer	Leila	Askö SeiBuKan Linz(SBK Linz)
AUT	Female	Neudorfer	Ella	ATSV Lenzing Sektion Karate(Lenzing)
AUT	Female	NOORI	LENIA	Askö SeiBuKan Linz(SBK Linz)
AUT	Female	Pehlic	Alisa	Shin Tai Karate Vöcklabruck(Shin Tai Karate Vöcklabruck)
AUT	Female	Roither	Mia	ATSV Lenzing Sektion Karate(Lenzing)
AUT	Female	Schell	Sophia	Shin Tai Karate Vöcklabruck(Shin Tai Karate Vöcklabruck)
AUT	Female	Seebauer	Franziska	ATSV Lenzing Sektion Karate(Lenzing)

ENTRY LIST

Kata Team female U12

CODE	Sex	Family Name	Given Name	Club / Team / NOC
AUT	Female	Skenderovic	Leona	Shin Tai Karate Vöcklabruck(Shin Tai Karate Vöcklabruck)
AUT	Female	Tran	Leonie	Askö SeiBuKan Linz(SBK Linz)

Entries: 16

Kata Team female U16

CODE	Sex	Family Name	Given Name	Club / Team / NOC
AUT	Female	Begovic	Nadija	Sportverein Karate-do Marchtrenk(Karate-do Marchtrenk)
AUT	Female	Covic	Saura	Sportverein Karate-do Marchtrenk(Karate-do Marchtrenk)
AUT	Female	Günther	Mia	Shin Tai Karate Vöcklabruck(Shin Tai Karate Vöcklabruck)
AUT	Female	Hinterberger	Mia	Union Karateclub Grieskirchen(UKC Grieskirchen)
AUT	Female	Huber	Sophia-Marie	Union Karateclub Grieskirchen(UKC Grieskirchen)
AUT	Female	Hörmandinger	Elina	Union Karateclub Grieskirchen(UKC Grieskirchen)
AUT	Female	Hüttner	Viktoria	Shotokan Karate Sportunion Altmünster(SPUA)
AUT	Female	Janecek	Elina	Shotokan Karate Sportunion Altmünster(SPUA)
AUT	Female	Jelica	Gabriela	Sportverein Karate-do Marchtrenk(Karate-do Marchtrenk)
AUT	Female	Jung	Lena	Shin Tai Karate Vöcklabruck(Shin Tai Karate Vöcklabruck)
AUT	Female	Memic	Hana	Sportverein Karate-do Marchtrenk(Karate-do Marchtrenk)
AUT	Female	Mittendorfer	Christina	Shotokan Karate Sportunion Altmünster(SPUA)
AUT	Female	Trumic	Amina	Sportverein Karate-do Marchtrenk(Karate-do Marchtrenk)
AUT	Female	Trumic	Sumeja	Sportverein Karate-do Marchtrenk(Karate-do Marchtrenk)
AUT	Female	Weinberger	Pia	Shin Tai Karate Vöcklabruck(Shin Tai Karate Vöcklabruck)

Entries: 15

Kata Team male U12

CODE	Sex	Family Name	Given Name	Club / Team / NOC
AUT	Male	Chen	Chenkai	Askö SeiBuKan Linz(SBK Linz)
AUT	Male	Flattinger	Ben	Union Karateclub Grieskirchen(UKC Grieskirchen)
AUT	Male	Heinisch	Leon	Askö SeiBuKan Linz(SBK Linz)
AUT	Male	Hemetsberger	Maximilian	Shin Tai Karate Vöcklabruck(Shin Tai Karate Vöcklabruck)
AUT	Male	Markovic	Andrej	Askö SeiBuKan Linz(SBK Linz)
AUT	Male	Mühlbauer	Alexander	Union Karateclub Grieskirchen(UKC Grieskirchen)
AUT	Male	Odobasic	Haris	ATSV Lenzing Sektion Karate(Lenzing)
AUT	Male	Roither	Michael	ATSV Lenzing Sektion Karate(Lenzing)
AUT	Male	Schindler	Laurenz	Union Karateclub Grieskirchen(UKC Grieskirchen)
AUT	Male	Schmid	Moritz	ATSV Lenzing Sektion Karate(Lenzing)
AUT	Male	Stroblmayr	Samuel	Shin Tai Karate Vöcklabruck(Shin Tai Karate Vöcklabruck)
AUT	Male	Wimmer	Jonas	Shin Tai Karate Vöcklabruck(Shin Tai Karate Vöcklabruck)

Entries: 12

ENTRY LIST

Kata Team male U21

CODE	Sex	Family Name	Given Name	Club / Team / NOC
AUT	Male	Ackerbauer	Andreas	Askö SeiBuKan Linz(SBK Linz)
AUT	Male	Eggl	Johannes	ATSV Lenzing Sektion Karate(Lenzing)
AUT	Male	Gaderer	Julian	Askö SeiBuKan Linz(SBK Linz)
AUT	Male	Galateanu	David	Askö SeiBuKan Linz(SBK Linz)
AUT	Male	Hosseini	Saro	ATSV Lenzing Sektion Karate(Lenzing)
AUT	Male	Mayr	Werner	Askö SeiBuKan Linz(SBK Linz)
AUT	Male	Nagel	Raphael	ATSV Lenzing Sektion Karate(Lenzing)
AUT	Male	Sedeqy	Josef	Askö SeiBuKan Linz(SBK Linz)
AUT	Male	Tran	Tommy	Askö SeiBuKan Linz(SBK Linz)

Entries: 9

Kumite Individual female Seniors +68

CODE	Sex	Family Name	Given Name	Club / Team / NOC
AUT	Female	Berisha	Natalie	Askö SeiBuKan Linz(SBK Linz)
AUT	Female	Blümelhuber	Bianca	ASKÖ Karate Steyr(Steyr)
AUT	Female	Sticht	Patricia	Askö SeiBuKan Linz(SBK Linz)

Entries: 3

Kumite Individual female Seniors -68

CODE	Sex	Family Name	Given Name	Club / Team / NOC
AUT	Female	Fuchs	Anna	Askö SeiBuKan Linz(SBK Linz)
AUT	Female	Jonas	Sarah	Shin Tai Karate Vöcklabruck(Shin Tai Karate Vöcklabruck)
AUT	Female	Pointner	Lisa	Askö SeiBuKan Linz(SBK Linz)

Entries: 3

Kumite Individual Female Seniors 35+ Open

CODE	Sex	Family Name	Given Name	Club / Team / NOC
AUT	Female	Ackerbauer	Sabine	Askö SeiBuKan Linz(SBK Linz)
AUT	Female	Ausserwöger	Corina	Askö SeiBuKan Linz(SBK Linz)
AUT	Female	Jung	Michaela	Shin Tai Karate Vöcklabruck(Shin Tai Karate Vöcklabruck)
AUT	Female	Schell	Carina	Shin Tai Karate Vöcklabruck(Shin Tai Karate Vöcklabruck)
AUT	Female	Schlögl	Andrea	Askö SeiBuKan Linz(SBK Linz)

Entries: 5

Kumite Individual female U10

CODE	Sex	Family Name	Given Name	Club / Team / NOC
AUT	Female	Bekas	Aryana	Shin Tai Karate Vöcklabruck(Shin Tai Karate Vöcklabruck)
AUT	Female	Grill	Amelie	Sportunion Schwandenstadt(Schw)
AUT	Female	Hackl	Lieselotte	Shin Tai Karate Vöcklabruck(Shin Tai Karate Vöcklabruck)
AUT	Female	NOORI	LENIA	Askö SeiBuKan Linz(SBK Linz)
AUT	Female	Schell	Sophia	Shin Tai Karate Vöcklabruck(Shin Tai Karate Vöcklabruck)
AUT	Female	Skenderovic	Leona	Shin Tai Karate Vöcklabruck(Shin Tai Karate Vöcklabruck)

ENTRY LIST

Kumite Individual female U10

CODE	Sex	Family Name	Given Name	Club / Team / NOC
AUT	Female	Tran	Leonie	Askö SeiBuKan Linz(SBK Linz)

Entries: 7

Kumite Individual female U12

CODE	Sex	Family Name	Given Name	Club / Team / NOC
AUT	Female	Huskic	Diana	Askö SeiBuKan Linz(SBK Linz)
AUT	Female	Islamovic	Emira	Askö SeiBuKan Linz(SBK Linz)
AUT	Female	Krammel	Verena	Askö SeiBuKan Linz(SBK Linz)
AUT	Female	Lichtenthal	Magdalena	Shin Tai Karate Vöcklabruck(Shin Tai Karate Vöcklabruck)
AUT	Female	Mitri	Jennifer	Askö SeiBuKan Linz(SBK Linz)
AUT	Female	Pehlic	Alisa	Shin Tai Karate Vöcklabruck(Shin Tai Karate Vöcklabruck)
AUT	Female	Salzmann	Ida	ASKÖ Neuhofen Karate Seibukan(Karate SBK Neuhofen)
AUT	Female	Schwarz	Antonella	ASKÖ Neuhofen Karate Seibukan(Karate SBK Neuhofen)
AUT	Female	Steininger	Charlotte	Askö SeiBuKan Linz(SBK Linz)
AUT	Female	Wendler	Mia Desireé	DSG Union Sankt Martin/Traun(DSG Union Traun)

Entries: 10

Kumite Individual female U14

CODE	Sex	Family Name	Given Name	Club / Team / NOC
AUT	Female	Covic	Saura	Sportverein Karate-do Marchtrenk(Karate-do Marchtrenk)
AUT	Female	Günther	Mia	Shin Tai Karate Vöcklabruck(Shin Tai Karate Vöcklabruck)
AUT	Female	Husidic	Dajra	Sportverein Karate-do Marchtrenk(Karate-do Marchtrenk)
AUT	Female	Jung	Lena	Shin Tai Karate Vöcklabruck(Shin Tai Karate Vöcklabruck)

Entries: 4

Kumite Individual female U16 +54

CODE	Sex	Family Name	Given Name	Club / Team / NOC
AUT	Female	Göbelhaider	Stephanie	ASKÖ Karate Steyr(Steyr)
AUT	Female	Hitsch	Sophie	Shin Tai Karate Vöcklabruck(Shin Tai Karate Vöcklabruck)
AUT	Female	Weinberger	Pia	Shin Tai Karate Vöcklabruck(Shin Tai Karate Vöcklabruck)
AUT	Female	Winkler	Alina	Shin Tai Karate Vöcklabruck(Shin Tai Karate Vöcklabruck)

Entries: 4

Kumite Individual female U16 -54

CODE	Sex	Family Name	Given Name	Club / Team / NOC
AUT	Female	Ablinger	Sarah	ATSV Seewalchen - Sektion Karate(Karate Seewalchen)
AUT	Female	Dinstl	Linda	ASKÖ Neuhofen Karate Seibukan(Karate SBK Neuhofen)
AUT	Female	Sakanovic	Adna	Karatedo Wels(Wels)



OÖ Landesmeisterschaft und OÖ Meisterschaft 2024

AUSTRIA
Europaplatz 5, 4663 Laakirchen

2024.04.13 - 2024.04.13

ENTRY LIST

Kumite Individual female U16 -54

CODE	Sex	Family Name	Given Name	Club / Team / NOC
AUT	Female	Turanovic	Lejla	ASKÖ Karate Steyr(Steyr)

Entries: 4

Kumite Individual female U18 +59

CODE	Sex	Family Name	Given Name	Club / Team / NOC
AUT	Female	Stockhammer	Miriam	ASKÖ Neuhofen Karate Seibukan(Karate SBK Neuhofen)

Entries: 1

Kumite Individual female U18 -53

CODE	Sex	Family Name	Given Name	Club / Team / NOC
AUT	Female	Galateanu	Evelyn	Askö SeiBuKan Linz(SBK Linz)
AUT	Female	Grudke	Linda	Shin Tai Karate Vöcklabruck(Shin Tai Karate Vöcklabruck)
AUT	Female	Islamovic	Ajla	Askö SeiBuKan Linz(SBK Linz)

Entries: 3

Kumite Individual female U18 -59

CODE	Sex	Family Name	Given Name	Club / Team / NOC
AUT	Female	Quatember	Luise	ASKÖ Karate Steyr(Steyr)

Entries: 1

Kumite Individual female U21 -55

CODE	Sex	Family Name	Given Name	Club / Team / NOC
AUT	Female	Jonas	Sarah	Shin Tai Karate Vöcklabruck(Shin Tai Karate Vöcklabruck)

Entries: 1

Kumite Individual male Seniors +84

CODE	Sex	Family Name	Given Name	Club / Team / NOC
AUT	Male	Egg	Johannes	ATSV Lenzing Sektion Karate(Lenzing)
AUT	Male	Haslhofer	Mario	ASKÖ Neuhofen Karate Seibukan(Karate SBK Neuhofen)
AUT	Male	Herac	Elvedin	Askö SeiBuKan Linz(SBK Linz)
AUT	Male	Nagel	Raphael	ATSV Lenzing Sektion Karate(Lenzing)
AUT	Male	Weinberger	Stefan	Shin Tai Karate Vöcklabruck(Shin Tai Karate Vöcklabruck)
AUT	Male	Yanardag	Ferdi	ASKÖ Karate Steyr(Steyr)

Entries: 6

Kumite Individual male Seniors -67

CODE	Sex	Family Name	Given Name	Club / Team / NOC
AUT	Male	Großhaupt	Erik	Sportunion Karate Gmunden(Gm)
AUT	Male	Huskic	Denis	Askö SeiBuKan Linz(SBK Linz)
AUT	Male	Wiesinger	Markus	Askö SeiBuKan Linz(SBK Linz)

Entries: 3

ENTRY LIST

Kumite Individual male Seniors -75

CODE	Sex	Family Name	Given Name	Club / Team / NOC
AUT	Male	Bachlmayr	Michael	Askö SeiBuKan Linz(SBK Linz)
AUT	Male	Grigorasenco	Nichita	LZ Oberösterreich(LZOÖ)
AUT	Male	Klinglmayr	Günther	Shin Tai Karate Vöcklabruck(Shin Tai Karate Vöcklabruck)
AUT	Male	Nagl	Gregor	Shin Tai Karate Vöcklabruck(Shin Tai Karate Vöcklabruck)

Entries: 4

Kumite Individual male Seniors -84

CODE	Sex	Family Name	Given Name	Club / Team / NOC
AUT	Male	FEILMAYR	RAPHAEL	Askö SeiBuKan Linz(SBK Linz)
AUT	Male	Hüttmeir	Tobias	Karatedo Wels(Wels)
AUT	Male	Reinsprecht	Stephan	Askö SeiBuKan Linz(SBK Linz)
AUT	Male	Vlacic	Aleksandar	Sportunion Schwanenstadt(Schw)
AUT	Male	Vlacic	Stefan	Sportunion Schwanenstadt(Schw)

Entries: 5

Kumite Individual Male Seniors 35+ Open

CODE	Sex	Family Name	Given Name	Club / Team / NOC
AUT	Male	Bachlmayr	Michael	Askö SeiBuKan Linz(SBK Linz)
AUT	Male	Klinglmayr	Günther	Shin Tai Karate Vöcklabruck(Shin Tai Karate Vöcklabruck)
AUT	Male	Reinsprecht	Stephan	Askö SeiBuKan Linz(SBK Linz)
AUT	Male	Schell	Thomas	Shin Tai Karate Vöcklabruck(Shin Tai Karate Vöcklabruck)
AUT	Male	Wiesinger	Markus	Askö SeiBuKan Linz(SBK Linz)
AUT	Male	Yanardag	Ferdi	ASKÖ Karate Steyr(Steyr)

Entries: 6

Kumite Individual male U10

CODE	Sex	Family Name	Given Name	Club / Team / NOC
AUT	Male	Hemetsberger	Maximilian	Shin Tai Karate Vöcklabruck(Shin Tai Karate Vöcklabruck)
AUT	Male	Markovic	Andrej	Askö SeiBuKan Linz(SBK Linz)
AUT	Male	Reichl	Finn	ASKÖ Neuhofen Karate Seibukan(Karate SBK Neuhofen)
AUT	Male	Zec	Danis	DSG Union Sankt Martin/Traun(DSG Union Traun)

Entries: 4

Kumite Individual male U12

CODE	Sex	Family Name	Given Name	Club / Team / NOC
AUT	Male	Bihorac	Muhamed	DSG Union Sankt Martin/Traun(DSG Union Traun)
AUT	Male	Chen	Chenkai	Askö SeiBuKan Linz(SBK Linz)
AUT	Male	Demic-Bachmair	Samy	ATSV Seewalchen - Sektion Karate(Karate Seewalchen)
AUT	Male	Heinisch	Leon	Askö SeiBuKan Linz(SBK Linz)
AUT	Male	Huber	Niclas	ASKÖ Neuhofen Karate Seibukan(Karate SBK Neuhofen)
AUT	Male	Mala Hamza	Hem	shindo ASKÖ Linz Auhof(shindo)

ENTRY LIST

Kumite Individual male U12				
CODE	Sex	Family Name	Given Name	Club / Team / NOC
AUT	Male	Stroblmayr	Samuel	Shin Tai Karate Vöcklabruck(Shin Tai Karate Vöcklabruck)
AUT	Male	Thaler	Dominik	Sportunion Karate Gmunden(Gm)
AUT	Male	Tijanovic	Adin	DSG Union Sankt Martin/Traun(DSG Union Traun)
AUT	Male	Wimmer	Jonas	Shin Tai Karate Vöcklabruck(Shin Tai Karate Vöcklabruck)
AUT	Male	Zhao	Junxi	Shin Tai Karate Vöcklabruck(Shin Tai Karate Vöcklabruck)

Entries: 11

Kumite Individual male U14				
CODE	Sex	Family Name	Given Name	Club / Team / NOC
AUT	Male	Beck	sebastian	ASKÖ Karate Steyr(Steyr)
AUT	Male	Burger	Diego	DSG Union Sankt Martin/Traun(DSG Union Traun)
AUT	Male	Cenanovic	Leon	Sportunion Schwanenstadt(Schw)
AUT	Male	Gaderer	Julian	Askö SeiBuKan Linz(SBK Linz)
AUT	Male	Hittenberger	Christopher Martin	Sportunion Attergau(Attergau)
AUT	Male	Kadic	Davud	DSG Union Sankt Martin/Traun(DSG Union Traun)
AUT	Male	Kapeller	Moritz	ASKÖ Karate Steyr(Steyr)
AUT	Male	Riedler	Jonas	Shin Tai Karate Vöcklabruck(Shin Tai Karate Vöcklabruck)
AUT	Male	Sedeqy	Josef	Askö SeiBuKan Linz(SBK Linz)
AUT	Male	Stieger	Jakob	Askö SeiBuKan Linz(SBK Linz)

Entries: 10

Kumite Individual male U16 +70				
CODE	Sex	Family Name	Given Name	Club / Team / NOC
AUT	Male	Beganovic	Sanid	Askö SeiBuKan Linz(SBK Linz)
AUT	Male	Hosseini	Saro	ATSV Lenzing Sektion Karate(Lenzing)
AUT	Male	Mayr	Werner	Askö SeiBuKan Linz(SBK Linz)

Entries: 3

Kumite Individual male U16 -52				
CODE	Sex	Family Name	Given Name	Club / Team / NOC
AUT	Male	Ackerbauer	Andreas	Askö SeiBuKan Linz(SBK Linz)
AUT	Male	Hankowetz	Jakob	ASKÖ Neuhofen Karate Seibukan(Karate SBK Neuhofen)
AUT	Male	Holzinger	Alexander	Shin Tai Karate Vöcklabruck(Shin Tai Karate Vöcklabruck)
AUT	Male	Voglhuber	Alexander	ATSV Seewalchen - Sektion Karate(Karate Seewalchen)

Entries: 4

Kumite Individual male U16 -57				
CODE	Sex	Family Name	Given Name	Club / Team / NOC
AUT	Male	Galateanu	David	Askö SeiBuKan Linz(SBK Linz)
AUT	Male	Uzunkaya	Semih	Askö SeiBuKan Linz(SBK Linz)
AUT	Male	Wienerroither	Lukas	ATSV Seewalchen - Sektion Karate(Karate Seewalchen)

ENTRY LIST

Entries: 3

Kumite Individual male U16 -63

CODE	Sex	Family Name	Given Name	Club / Team / NOC
AUT	Male	Bogad	Patrick	ATSV Seewalchen - Sektion Karate(Karate Seewalchen)
AUT	Male	CHEBAN	Oleksandr	LZ Oberösterreich(LZOÖ)
AUT	Male	Sakanovic	Adin	Karatedo Wels(Wels)

Entries: 3

Kumite Individual male U18 -76

CODE	Sex	Family Name	Given Name	Club / Team / NOC
AUT	Male	FORTNER	NIKLAS	Askö SeiBuKan Linz(SBK Linz)
AUT	Male	Krawczyk	Dawid	Shin Tai Karate Vöcklabruck(Shin Tai Karate Vöcklabruck)
AUT	Male	Wintersperger	Lorenz	ASKÖ Neuhofen Karate Seibukan(Karate SBK Neuhofen)

Entries: 3

Kumite Individual male U21 Open

CODE	Sex	Family Name	Given Name	Club / Team / NOC
AUT	Male	Eggl	Johannes	ATSV Lenzing Sektion Karate(Lenzing)
AUT	Male	Grigorasenco	Nichita	LZ Oberösterreich(LZOÖ)
AUT	Male	Huskic	Denis	Askö SeiBuKan Linz(SBK Linz)
AUT	Male	Nagel	Raphael	ATSV Lenzing Sektion Karate(Lenzing)

Entries: 4

Kumite Team female Sen

CODE	Sex	Family Name	Given Name	Club / Team / NOC
AUT	Female	Ackerbauer	Sabine	Askö SeiBuKan Linz(SBK Linz)
AUT	Female	Ausserwöger	Corina	Askö SeiBuKan Linz(SBK Linz)
AUT	Female	Berisha	Natalie	Askö SeiBuKan Linz(SBK Linz)
AUT	Female	Fuchs	Anna	Askö SeiBuKan Linz(SBK Linz)
AUT	Female	Ikic	Vanessa	Askö SeiBuKan Linz(SBK Linz)
AUT	Female	Jonas	Sarah	Shin Tai Karate Vöcklabruck(Shin Tai Karate Vöcklabruck)
AUT	Female	Jung	Michaela	Shin Tai Karate Vöcklabruck(Shin Tai Karate Vöcklabruck)
AUT	Female	Pointner	Lisa	Askö SeiBuKan Linz(SBK Linz)
AUT	Female	Schell	Carina	Shin Tai Karate Vöcklabruck(Shin Tai Karate Vöcklabruck)
AUT	Female	Schlögl	Andrea	Askö SeiBuKan Linz(SBK Linz)
AUT	Female	Sticht	Patricia	Askö SeiBuKan Linz(SBK Linz)
AUT	Female	Öllinger	Anna	Askö SeiBuKan Linz(SBK Linz)

Entries: 12

Kumite Team male Sen

CODE	Sex	Family Name	Given Name	Club / Team / NOC
AUT	Male	Bachlmayr	Michael	Askö SeiBuKan Linz(SBK Linz)
AUT	Male	Böheim	Martin	Askö SeiBuKan Linz(SBK Linz)
AUT	Male	FEILMAYR	RAPHAEL	Askö SeiBuKan Linz(SBK Linz)

ENTRY LIST

Kumite Team male Sen

CODE	Sex	Family Name	Given Name	Club / Team / NOC
AUT	Male	Großhaupt	Erik	Shin Tai Karate Vöcklabruck(Shin Tai Karate Vöcklabruck)
AUT	Male	Hagleitner	Oliver	Askö SeiBuKan Linz(SBK Linz)
AUT	Male	Herac	Elvedin	Askö SeiBuKan Linz(SBK Linz)
AUT	Male	Huskic	Denis	Askö SeiBuKan Linz(SBK Linz)
AUT	Male	Klinglmayr	Günther	Shin Tai Karate Vöcklabruck(Shin Tai Karate Vöcklabruck)
AUT	Male	Ladstätter	Alexander	Askö SeiBuKan Linz(SBK Linz)
AUT	Male	Nagl	Gregor	Shin Tai Karate Vöcklabruck(Shin Tai Karate Vöcklabruck)
AUT	Male	Reinsprecht	Stephan	Askö SeiBuKan Linz(SBK Linz)
AUT	Male	Schell	Thomas	Shin Tai Karate Vöcklabruck(Shin Tai Karate Vöcklabruck)
AUT	Male	Weinberger	Stefan	Shin Tai Karate Vöcklabruck(Shin Tai Karate Vöcklabruck)
AUT	Male	Wiesinger	Markus	Askö SeiBuKan Linz(SBK Linz)

Entries: **14**

Kumite Team male U16

CODE	Sex	Family Name	Given Name	Club / Team / NOC
AUT	Male	Ackerbauer	Andreas	Askö SeiBuKan Linz(SBK Linz)
AUT	Male	Galateanu	David	Askö SeiBuKan Linz(SBK Linz)
AUT	Male	Mayr	Werner	Askö SeiBuKan Linz(SBK Linz)

Entries: **3**

Total Entries: **396**

Statistics

Participating Countries: 1

Participating Regions: 1

Participating Team/Clubs: 17

	Competitors	Entries
Female	100	159
Male	110	172
Total	210	331

Entries per Category

	Entries	Teams
Kata Individual female Sen +35	7	-
Kata Individual female Sen +45	1	-
Kata Individual female Seniors	13	-
Kata Individual female U10	15	-
Kata Individual female U12	21	-
Kata Individual female U14	17	-
Kata Individual female U16	15	-
Kata Individual female U18	4	-
Kata Individual female U21	3	-
Kata Individual male Sen +45	5	-
Kata Individual male Sen+35	7	-
Kata Individual male Seniors	13	-
Kata Individual male U10	17	-
Kata Individual male U12	16	-
Kata Individual male U14	14	-
Kata Individual male U16	14	-
Kata Individual male U21	6	-
Kata Team female Seniors	-	4
Kata Team female U12	-	5
Kata Team female U16	-	5
Kata Team male U12	-	4
Kata Team male U21	-	3
Kumite Individual Female Seniors 35+ Open	5	-
Kumite Individual Male Seniors 35+ Open	6	-
Kumite Individual female Seniors +68	3	-
Kumite Individual female Seniors -68	3	-
Kumite Individual female U10	7	-
Kumite Individual female U12	10	-
Kumite Individual female U14	4	-
Kumite Individual female U16 +54	4	-

Statistics

Kumite Individual female U16 -54	4	-
Kumite Individual female U18 +59	1	-
Kumite Individual female U18 -53	3	-
Kumite Individual female U18 -59	1	-
Kumite Individual female U21 -55	1	-
Kumite Individual male Seniors +84	6	-
Kumite Individual male Seniors -67	3	-
Kumite Individual male Seniors -75	4	-
Kumite Individual male Seniors -84	5	-
Kumite Individual male U10	4	-
Kumite Individual male U12	11	-
Kumite Individual male U14	10	-
Kumite Individual male U16 +70	3	-
Kumite Individual male U16 -52	4	-
Kumite Individual male U16 -57	3	-
Kumite Individual male U16 -63	3	-
Kumite Individual male U18 -76	3	-
Kumite Individual male U21 Open	4	-
Kumite Team female Sen	-	3
Kumite Team male Sen	-	3
Kumite Team male U16	-	1
Totals:	303	28

KATA INDIVIDUAL FEMALE SEN +35

Kata Individual female Sen +35

OÖ Landesmeisterschaft und OÖ Meisterschaft 2024, Europaplatz 5, 4663 Laakirchen, AUT

2024-04-13

Tatami

3 09:35

Pool

1/1

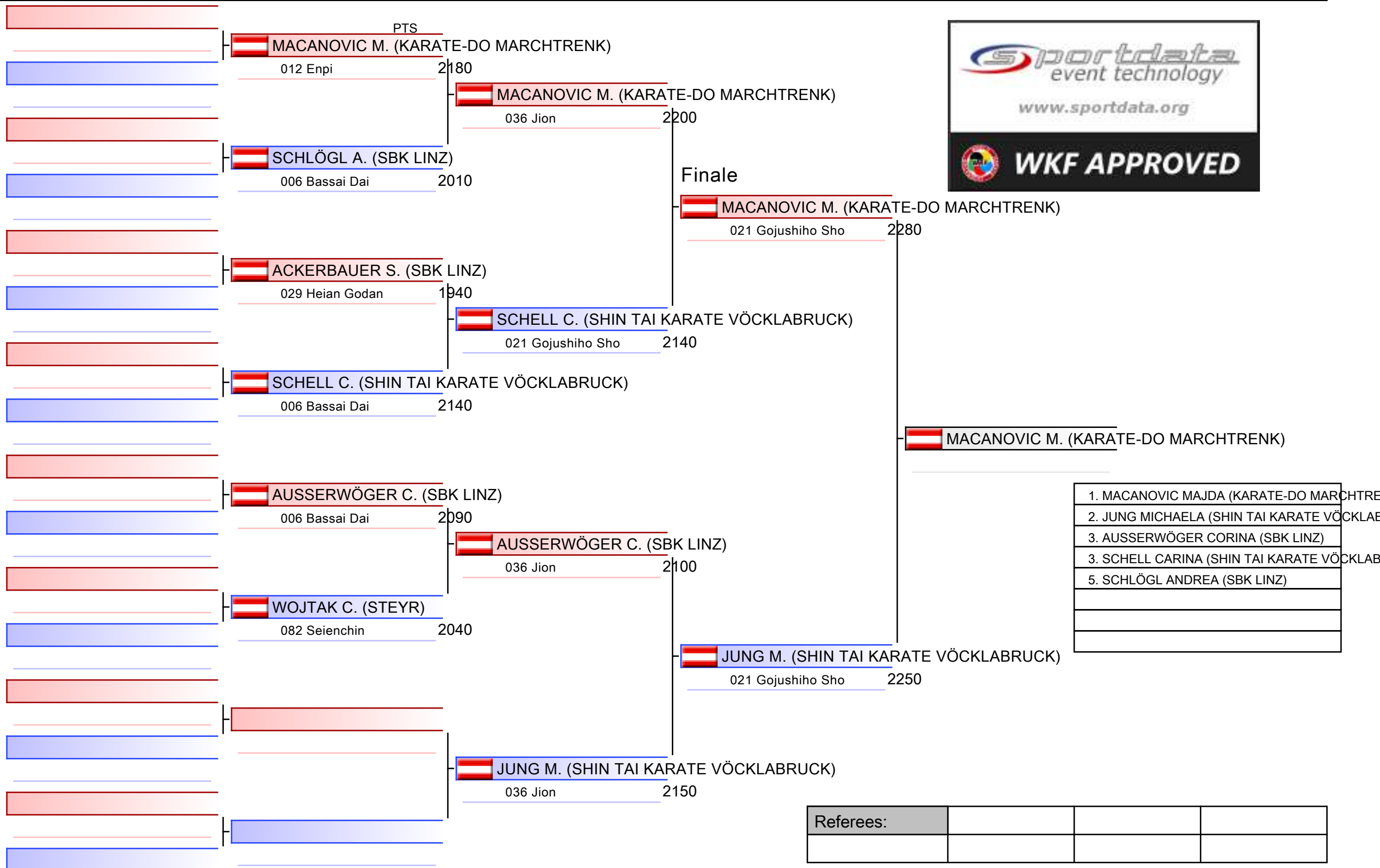

Kata Individual female Sen +35

OÖ Landesmeisterschaft und OÖ Meisterschaft 2024

2024-04-13

Tatami
3 09:35

Pool
1

(c)sportdata GmbH & Co KG 2000-2024 (2024-04-14 21:43) v 10.2.0 build 1 (2024-04-06 19:39 CET) Lizenz: SDIL_TV-GRAPHICS (expire 2024-12-31)

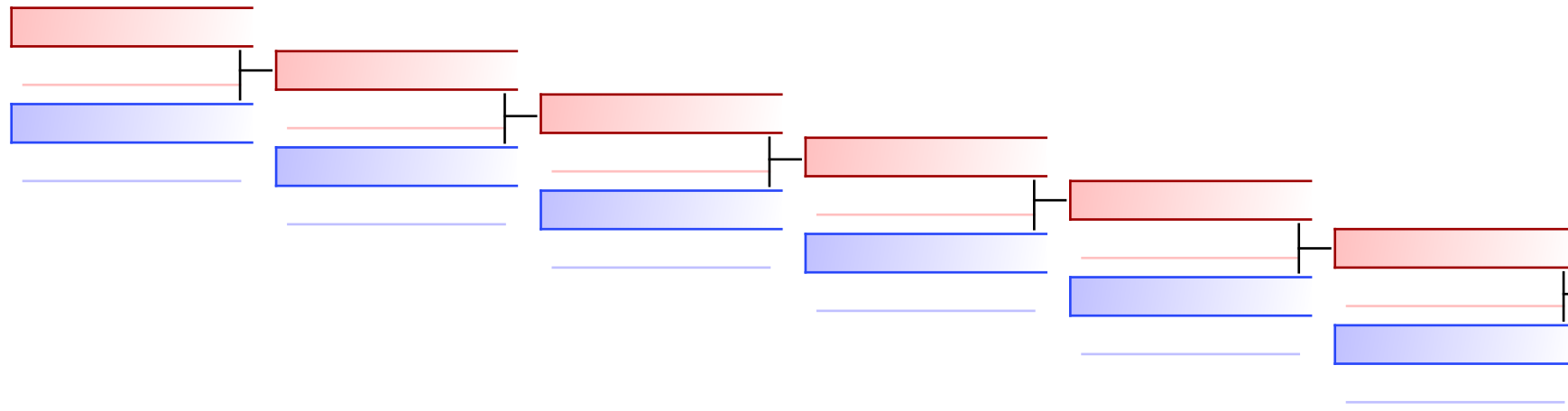



 Schlögl Andrea (SBK Linz)
036 Jion | 1950

 Schell Carina (Shin Tai Karate Vöcklabruck)

 Schell Carina (Shin Tai Karate Vöcklabruck)
036 Jion | 2140

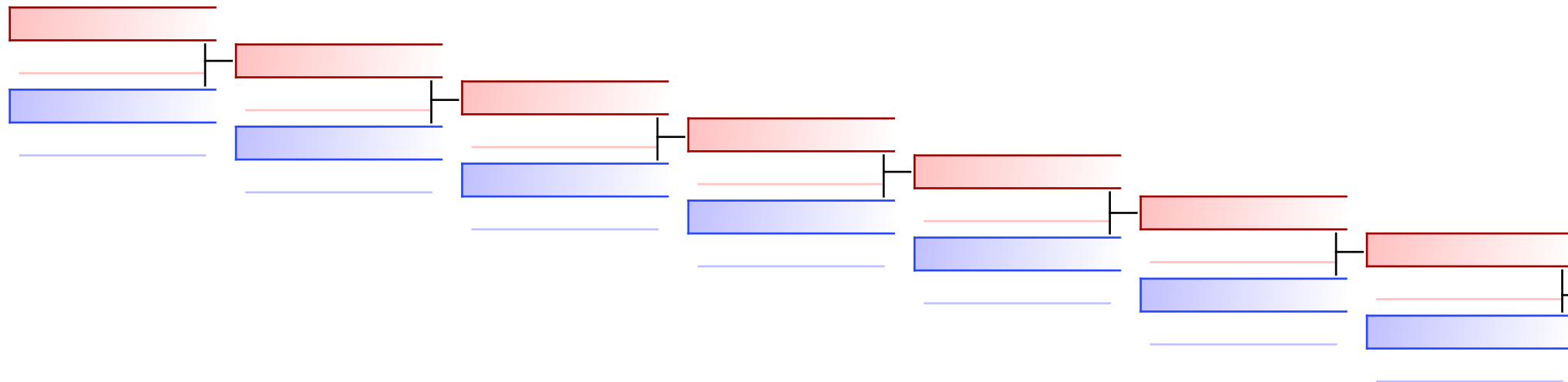
TROSTRUNDE: (1)







 Ausserwöger Corina (SBK Linz)

Referees:							
-----------	--	--	--	--	--	--	--



OÖ Landesmeisterschaft und OÖ
Meisterschaft 2024 - 2024-04-13

Offizielle Ergebnisliste

Kata Individual female Sen +35			
1	MACANOVIC MAJDA		AUT - AUSTRIA
2	JUNG MICHAELA		AUT - AUSTRIA
3	AUSSERWÖGER CORINA		AUT - AUSTRIA
3	SHELL CARINA		AUT - AUSTRIA
5	SCHLÖGL ANDREA		AUT - AUSTRIA

KATA INDIVIDUAL FEMALE SENIORS

Kata Individual female Seniors

OÖ Landesmeisterschaft und OÖ Meisterschaft 2024, Europaplatz 5, 4663 Laakirchen, AUT

2024-04-13

Tatami

2 15:20

Pool

1/1

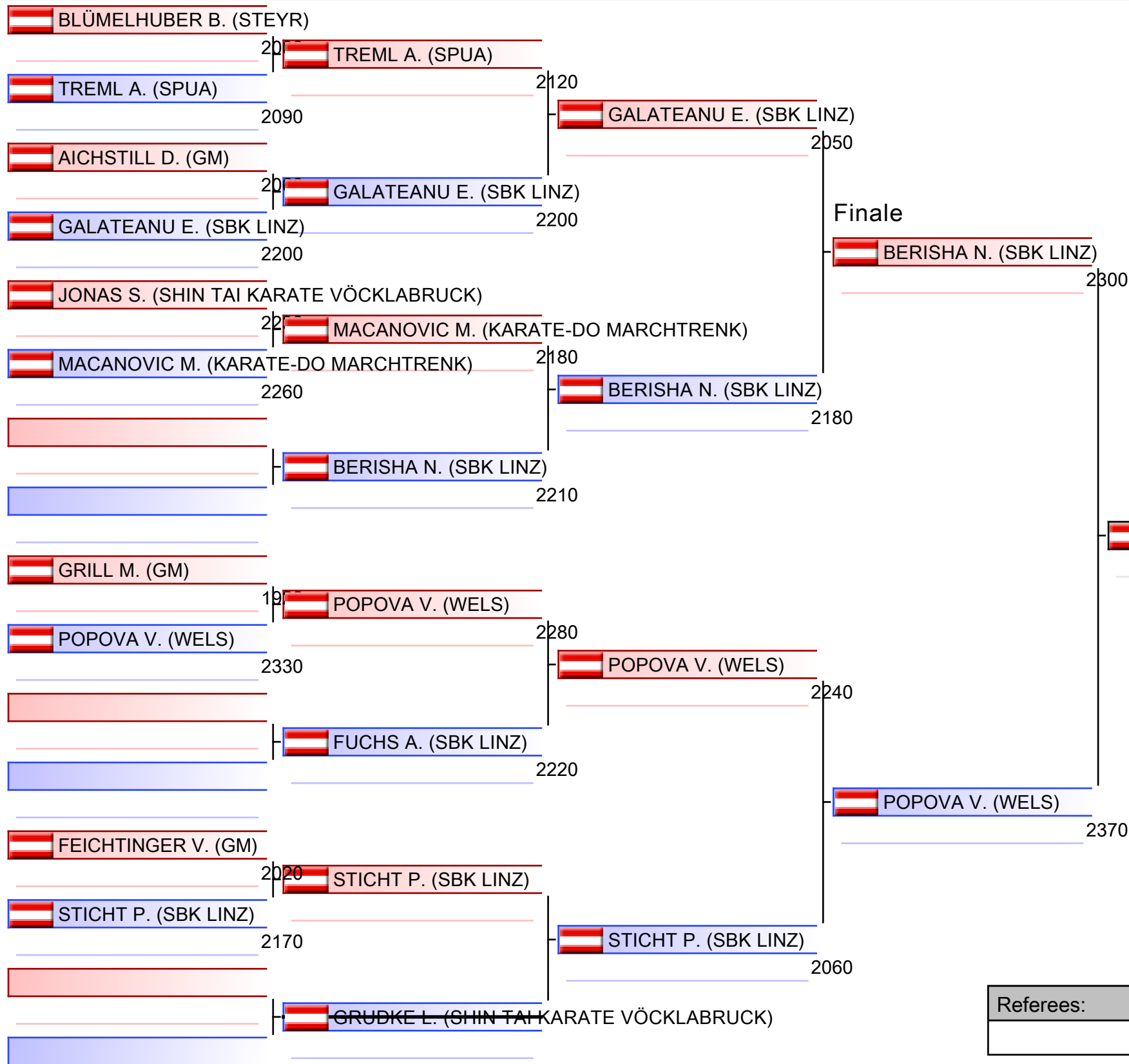

1. POPOVA VARVARA (WELS)
2. BERISHA NATALIE (SBK LINZ)
3. MACANOVIC MAJDA (KARATE-DO MARCHTRENK)
3. FUCHS ANNA (SBK LINZ)
5. GALATEANU EVELYN (SBK LINZ)
5. STICHT PATRICIA (SBK LINZ)
7. GRILL MELANIE (GM)

Referees:			

Kata Individual female Seniors

OÖ Landesmeisterschaft und OÖ Meisterschaft 2024

2024-04-13

Tatami
2 15:20

Pool
1

(c)sportdata GmbH & Co KG 2000-2024 (2024-04-14 21:43) v 10.2.0 build 1 (2024-04-06 19:39 CET) Lizenz: SDIL_TV-GRAPHICS (expire 2024-12-31)

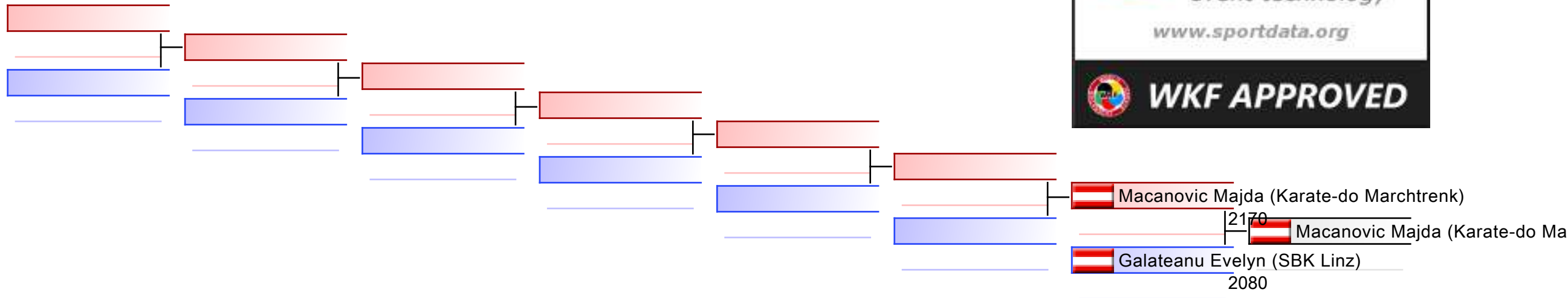

TROSTRUNDE: (1)

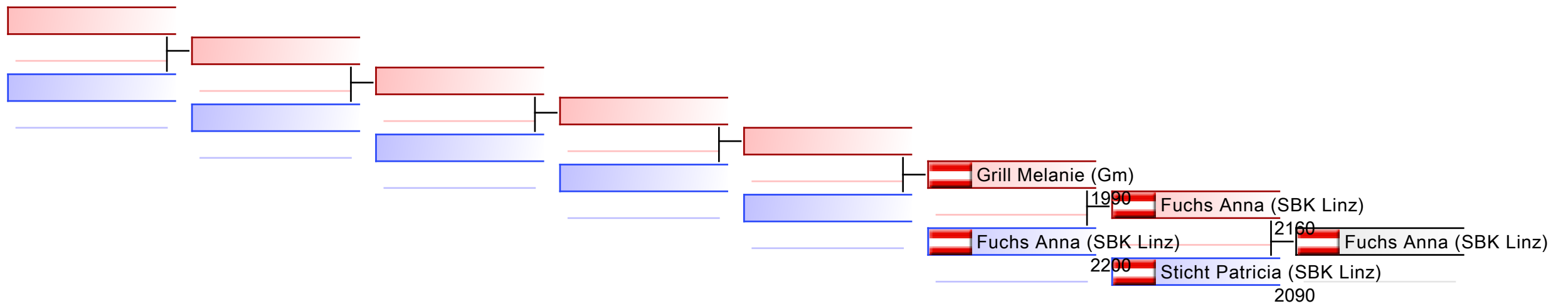



Referees:							
-----------	--	--	--	--	--	--	--



OÖ Landesmeisterschaft und OÖ
Meisterschaft 2024 - 2024-04-13

Offizielle Ergebnisliste

Kata Individual female Seniors			
1	POPOVA VARVARA		AUT - AUSTRIA
2	BERISHA NATALIE		AUT - AUSTRIA
3	MACANOVIC MAJDA		AUT - AUSTRIA
3	FUCHS ANNA		AUT - AUSTRIA
5	GALATEANU EVELYN		AUT - AUSTRIA
5	STICHT PATRICIA		AUT - AUSTRIA
7	GRILL MELANIE		AUT - AUSTRIA

KATA INDIVIDUAL FEMALE U10

Kata Individual female U10

OÖ Landesmeisterschaft und OÖ Meisterschaft 2024, Europaplatz 5, 4663 Laakirchen, AUT

2024-04-13

Tatami

1 09:00

Pool

1/1

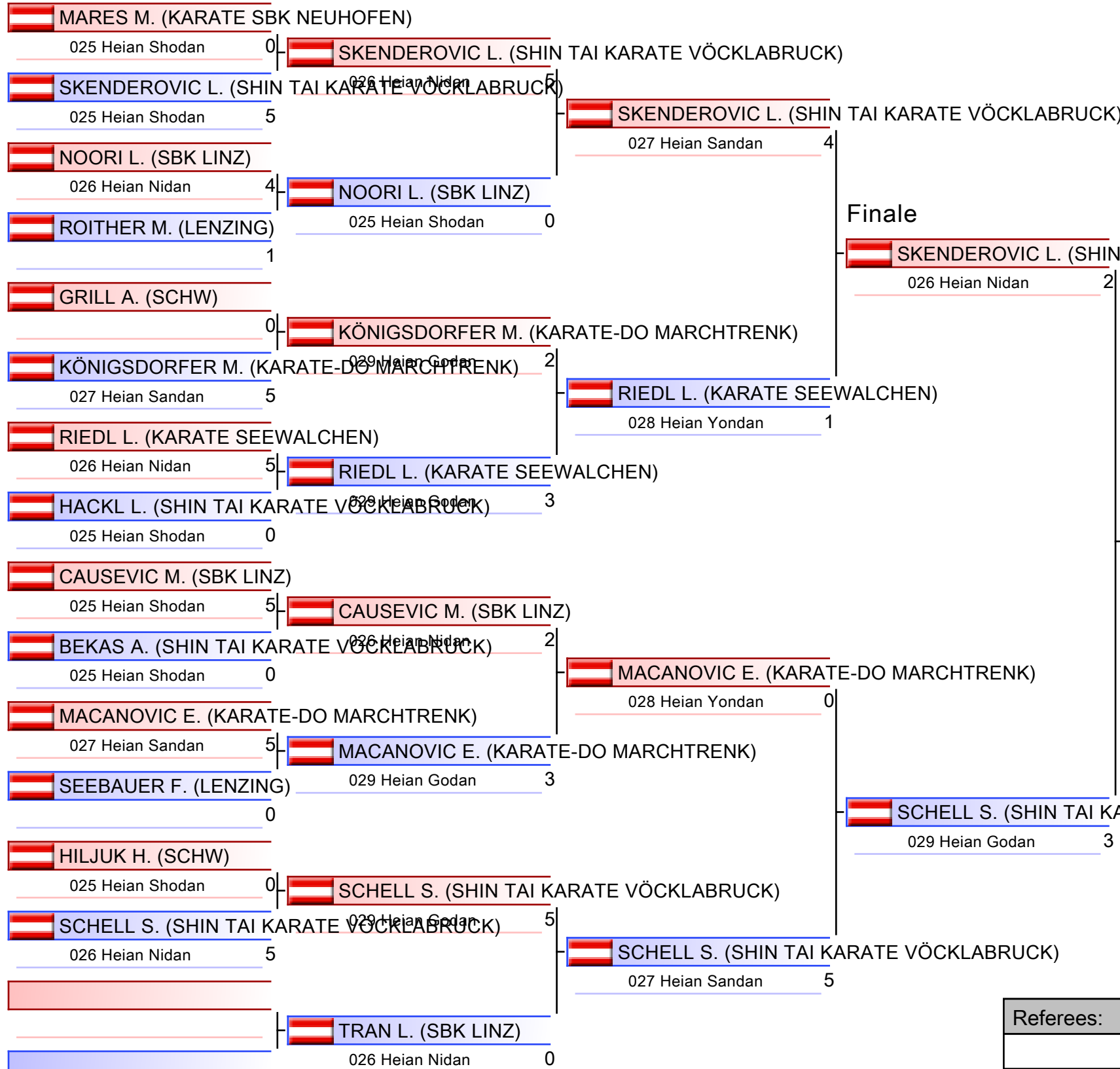

1. SCHELL SOPHIA (SHIN TAI KARATE VÖCKLABRUCK)
2. SKENDEROVIC LEONA (SHIN TAI KARATE VÖCKLABRUCK)
3. NOORI LENIA (SBK LINZ)
3. MACANOVIC EMA (KARATE-DO MARCHTRENK)
5. RIEDL LILIA (KARATE SEEWALCHEN)
5. TRAN LEONIE (SBK LINZ)
7. MARES MIRIAM (KARATE SBK NEUHOFEN)
7. HILJUK HELENA (SCHW)

Referees:			

Kata Individual female U10

OÖ Landesmeisterschaft und OÖ Meisterschaft 2024

2024-04-13

Tatami
1 09:00

Pool
1

(c)sportdata GmbH & Co KG 2000-2024 (2024-04-14 21:43) v 10.2.0 build 1 (2024-04-06 19:39 CET) Lizenz: SDIL_TV-GRAPHICS (expire 2024-12-31)

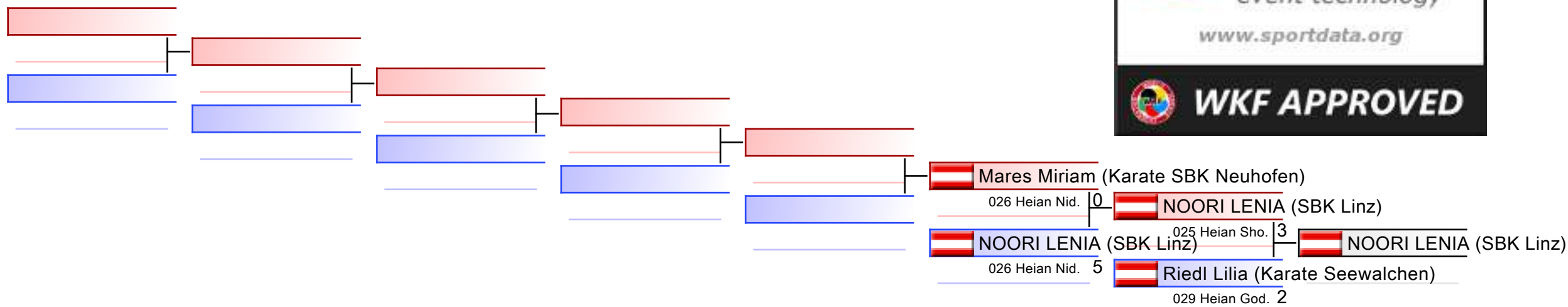

TROSTRUNDE: (1)

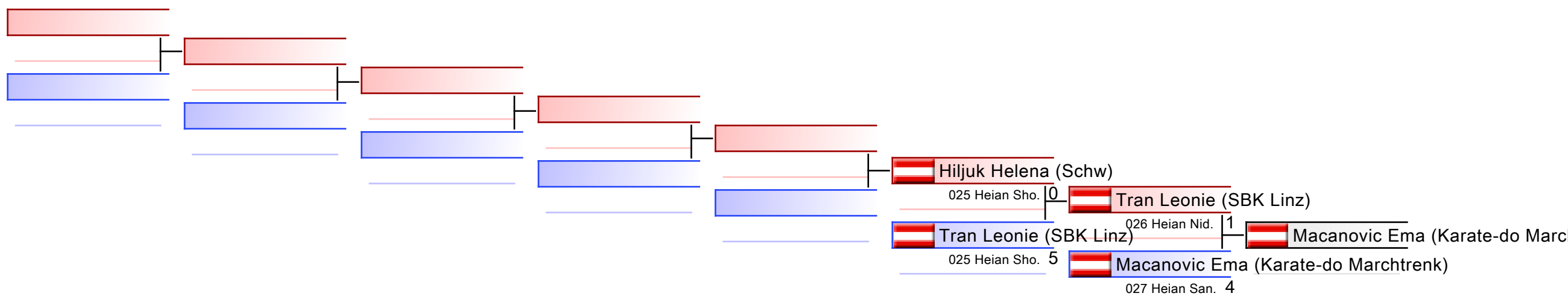









Referees:							
-----------	--	--	--	--	--	--	--



OÖ Landesmeisterschaft und OÖ
Meisterschaft 2024 - 2024-04-13

Offizielle Ergebnisliste

Kata Individual female U10			
1	SCHELL SOPHIA		AUT - AUSTRIA
2	SKENDEROVIC LEONA		AUT - AUSTRIA
3	NOORI LENIA		AUT - AUSTRIA
3	MACANOVIC EMA		AUT - AUSTRIA
5	RIEDL LILIA		AUT - AUSTRIA
5	TRAN LEONIE		AUT - AUSTRIA
7	MARES MIRIAM		AUT - AUSTRIA
7	HILJUK HELENA		AUT - AUSTRIA

KATA INDIVIDUAL FEMALE U12

Kata Individual female U12

OÖ Landesmeisterschaft und OÖ Meisterschaft 2024, Europaplatz 5, 4663 Laakirchen, AUT

2024-04-13

Tatami
1 09:30

Pool
1/1

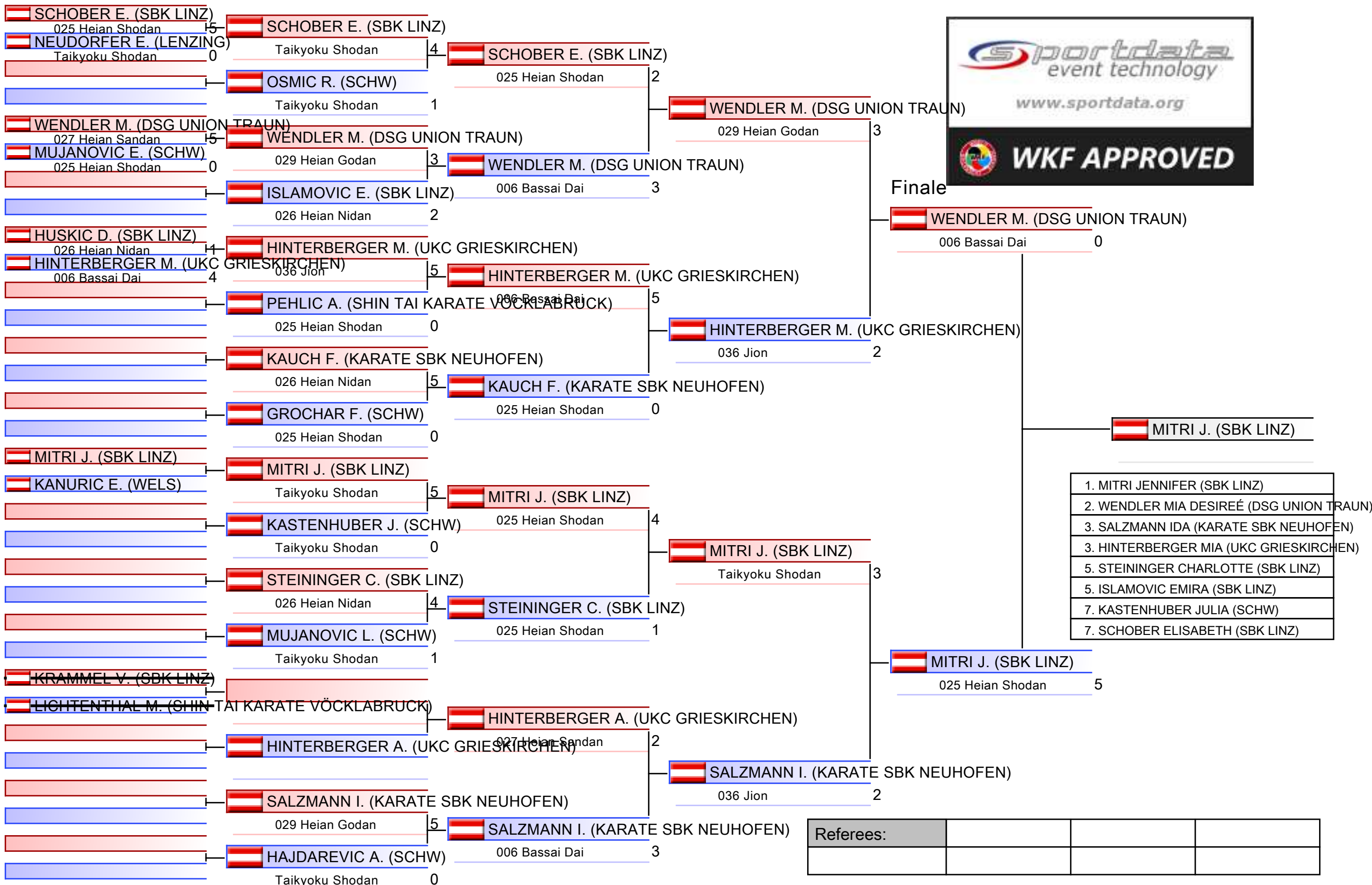

- | |
|--|
| 1. MITRI JENNIFER (SBK LINZ) |
| 2. WENDLER MIA DESIREÉ (DSG UNION TRAUN) |
| 3. SALZMANN IDA (KARATE SBK NEUHOFEN) |
| 3. HINTERBERGER MIA (UKC GRIESKIRCHEN) |
| 5. STEININGER CHARLOTTE (SBK LINZ) |
| 5. ISLAMOVIĆ EMIRA (SBK LINZ) |
| 7. KASTENHUBER JULIA (SCHW) |
| 7. SCHOBER ELISABETH (SBK LINZ) |

Kata Individual female U12

OÖ Landesmeisterschaft und OÖ Meisterschaft 2024

2024-04-13

Tatami
1 09:30

Pool
1

(c)sportdata GmbH & Co KG 2000-2024 (2024-04-14 21:43) v 10.2.0 build 1 (2024-04-06 19:39 CET) Lizenz: SDIL_TV-GRAPHICS (expire 2024-12-31)

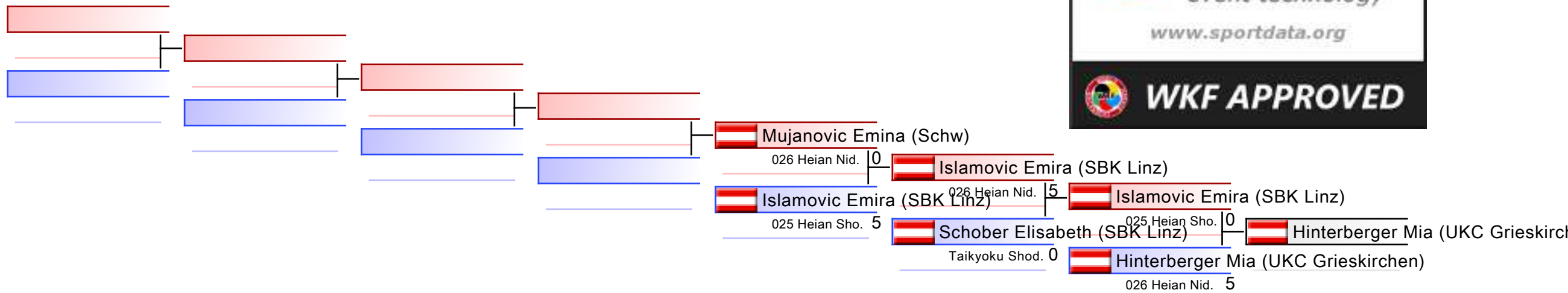

TROSTRUNDE: (1)

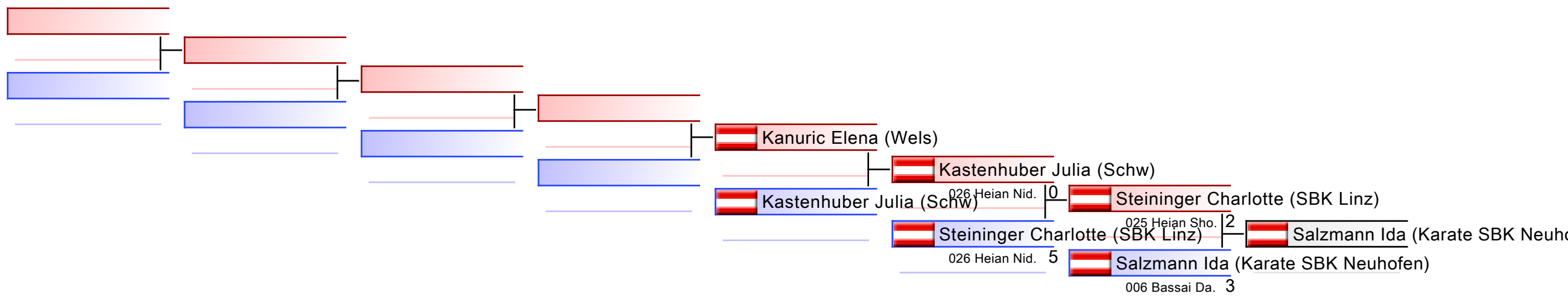











Referees:							
-----------	--	--	--	--	--	--	--



OÖ Landesmeisterschaft und OÖ
Meisterschaft 2024 - 2024-04-13

Offizielle Ergebnisliste

Kata Individual female U12			
1	MITRI JENNIFER		AUT - AUSTRIA
2	WENDLER MIA DESIRÉE		AUT - AUSTRIA
3	SALZMANN IDA		AUT - AUSTRIA
3	HINTERBERGER MIA		AUT - AUSTRIA
5	STEININGER CHARLOTTE		AUT - AUSTRIA
5	ISLAMOVIC EMIRA		AUT - AUSTRIA
7	KASTENHUBER JULIA		AUT - AUSTRIA
7	SCHOBER ELISABETH		AUT - AUSTRIA
9	KANURIC ELENA		AUT - AUSTRIA
9	MUJANOVIC EMINA		AUT - AUSTRIA

KATA INDIVIDUAL FEMALE U14

Kata Individual female U14

OÖ Landesmeisterschaft und OÖ Meisterschaft 2024, Europaplatz 5, 4663 Laakirchen, AUT

2024-04-13

Tatami
1 10:10

Pool
1/1

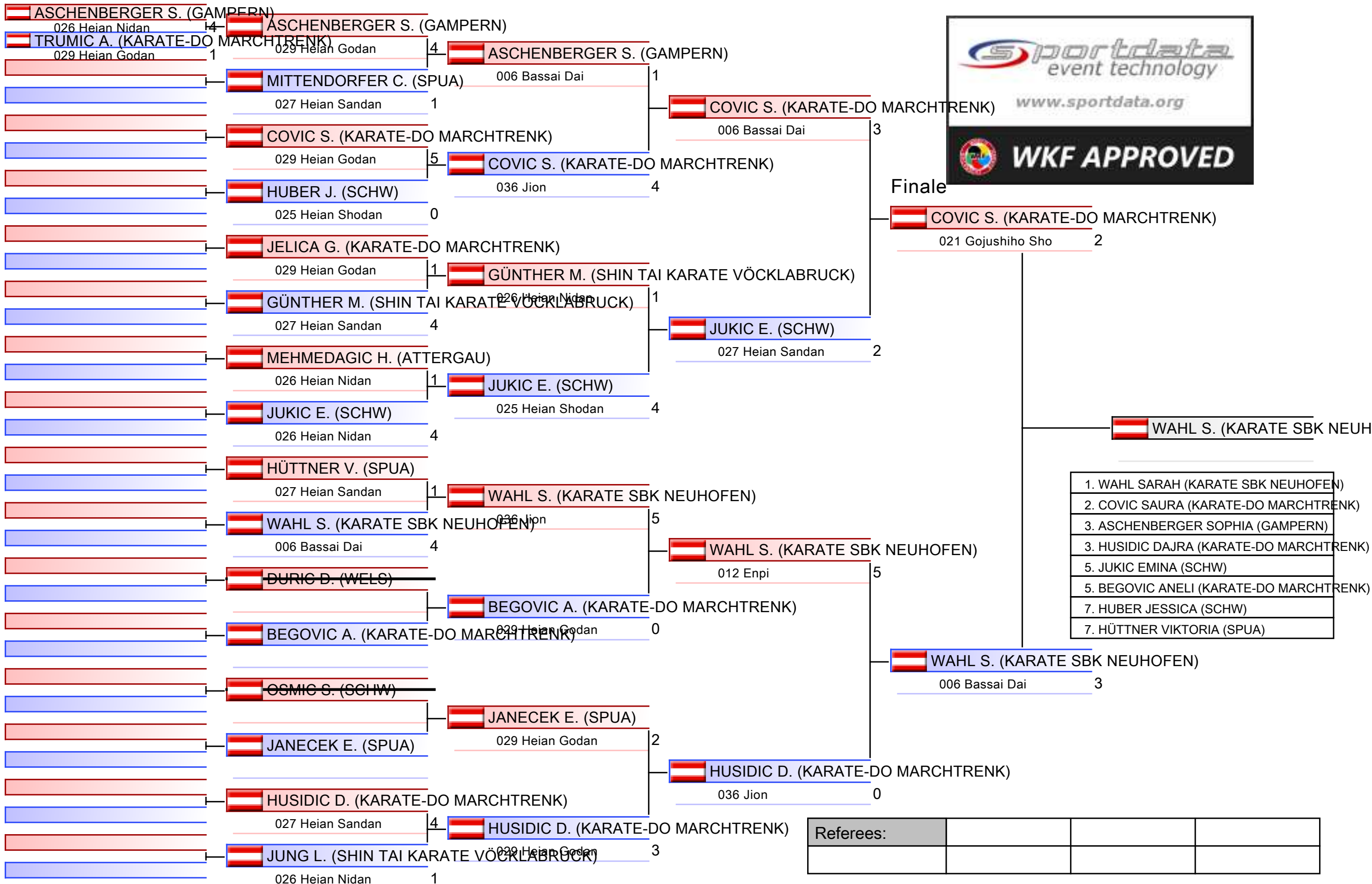

Referees:			

Kata Individual female U14

OÖ Landesmeisterschaft und OÖ Meisterschaft 2024

2024-04-13

Tatami
1 10:10

Pool
1

(c)sportdata GmbH & Co KG 2000-2024 (2024-04-14 21:43) v 10.2.0 build 1 (2024-04-06 19:39 CET) Lizenz: SDIL_TV-GRAPHICS (expire 2024-12-31)

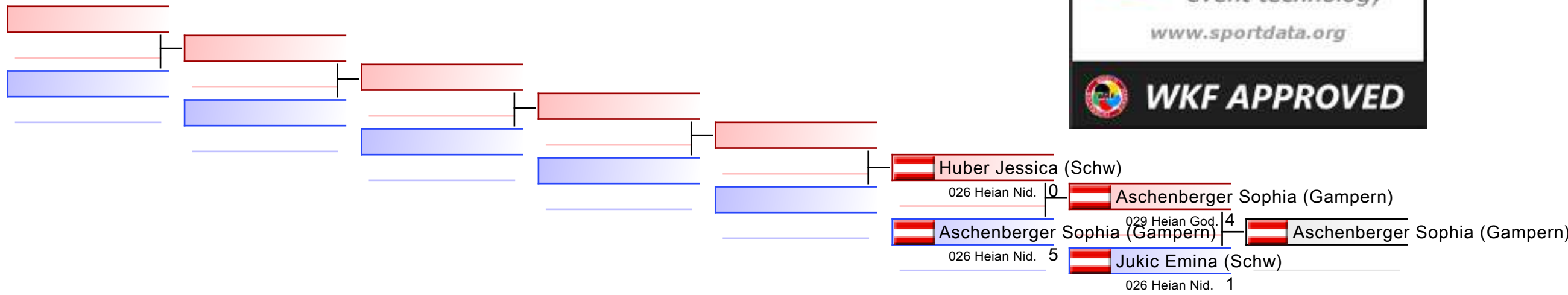

TROSTRUNDE: (1)

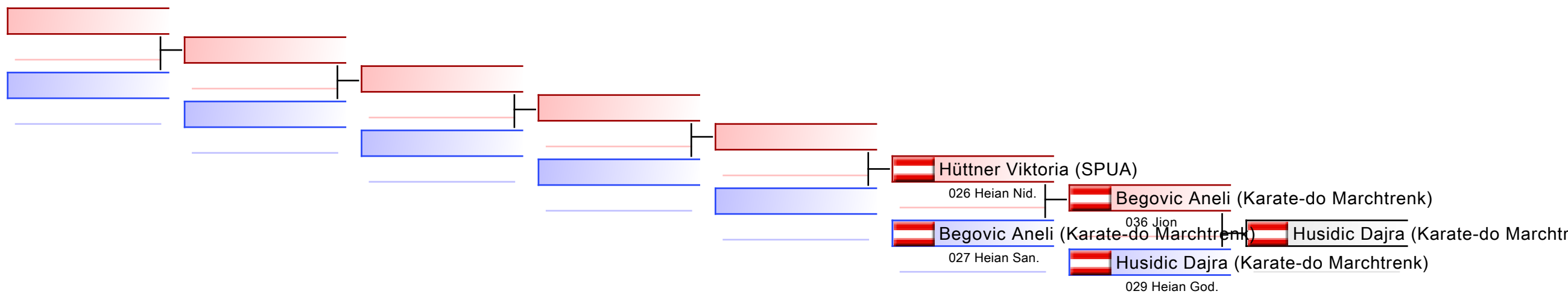









Referees:							
-----------	--	--	--	--	--	--	--



OÖ Landesmeisterschaft und OÖ
Meisterschaft 2024 - 2024-04-13

Offizielle Ergebnisliste

Kata Individual female U14			
1	WAHL SARAH		AUT - AUSTRIA
2	COVIC SAURA		AUT - AUSTRIA
3	ASCHENBERGER SOPHIA		AUT - AUSTRIA
3	HUSIDIC DAJRA		AUT - AUSTRIA
5	JUKIC EMINA		AUT - AUSTRIA
5	BEGOVIC ANELI		AUT - AUSTRIA
7	HUBER JESSICA		AUT - AUSTRIA
7	HÜTTNER VIKTORIA		AUT - AUSTRIA

KATA INDIVIDUAL FEMALE U16

Kata Individual female U16

OÖ Landesmeisterschaft und OÖ Meisterschaft 2024, Europaplatz 5, 4663 Laakirchen, AUT

2024-04-13

Tatami

1 10:45

Pool

1/1

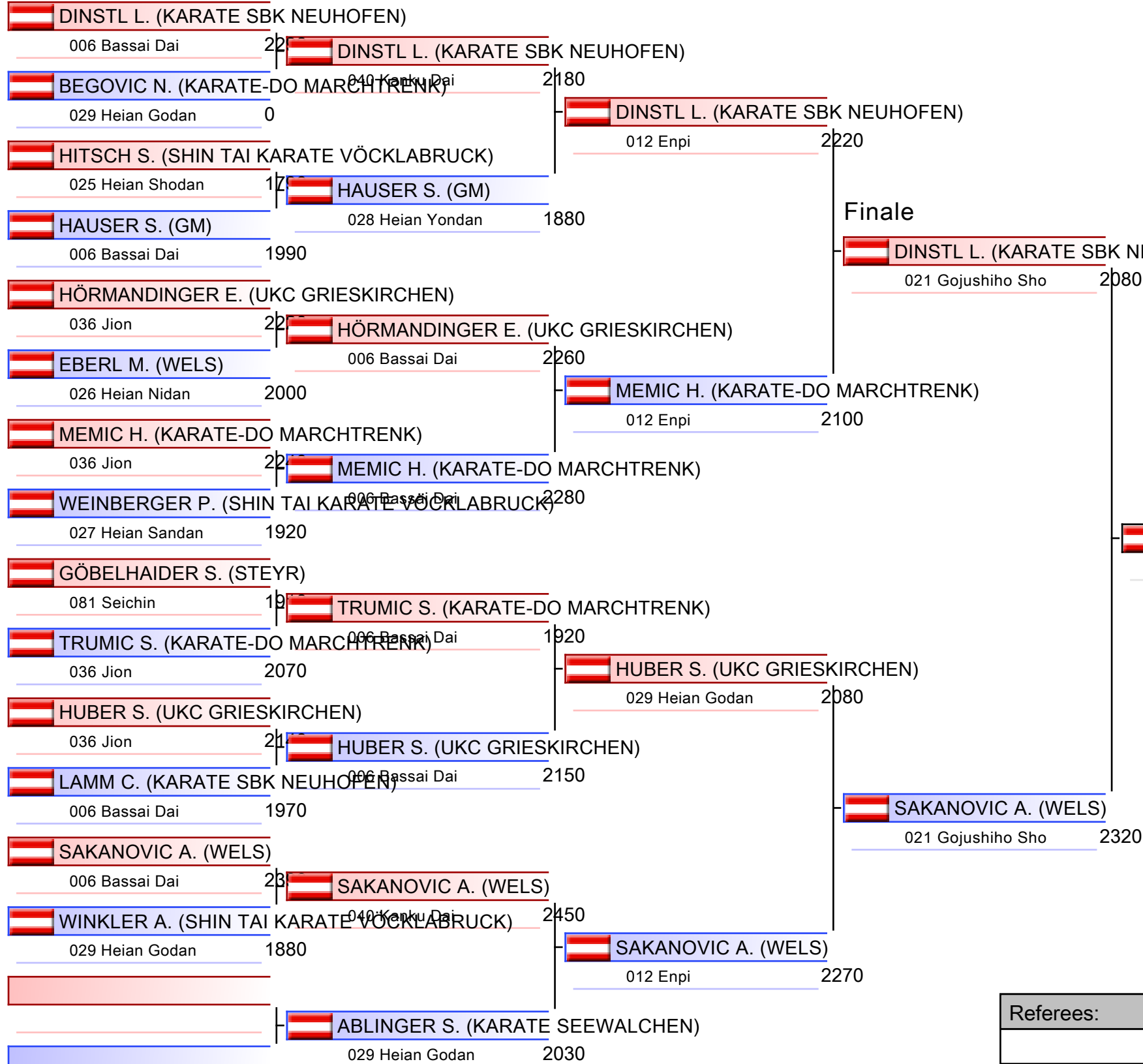

- | |
|--|
| 1. SAKANOVIC ADNA (WELS) |
| 2. DINSTL LINDA (KARATE SBK NEUHOFEN) |
| 3. MEMIC HANA (KARATE-DO MARCHTRENK) |
| 3. ABLINGER SARAH (KARATE SEEWALCHEN) |
| 5. HAUSER SOPHIE (GM) |
| 5. HUBER SOPHIA-MARIE (UKC GRIESKIRCHEN) |
| 7. BEGOVIC NADIJA (KARATE-DO MARCHTRENK) |
| 7. WINKLER ALINA (SHIN TAI KARATE VÖCKLABRUCK) |

Referees:			

Kata Individual female U16

OÖ Landesmeisterschaft und OÖ Meisterschaft 2024

2024-04-13

Tatami
1 10:45

Pool
1

(c)sportdata GmbH & Co KG 2000-2024 (2024-04-14 21:43) v 10.2.0 build 1 (2024-04-06 19:39 CET) Lizenz: SDIL_TV-Graphics (expire 2024-12-31)

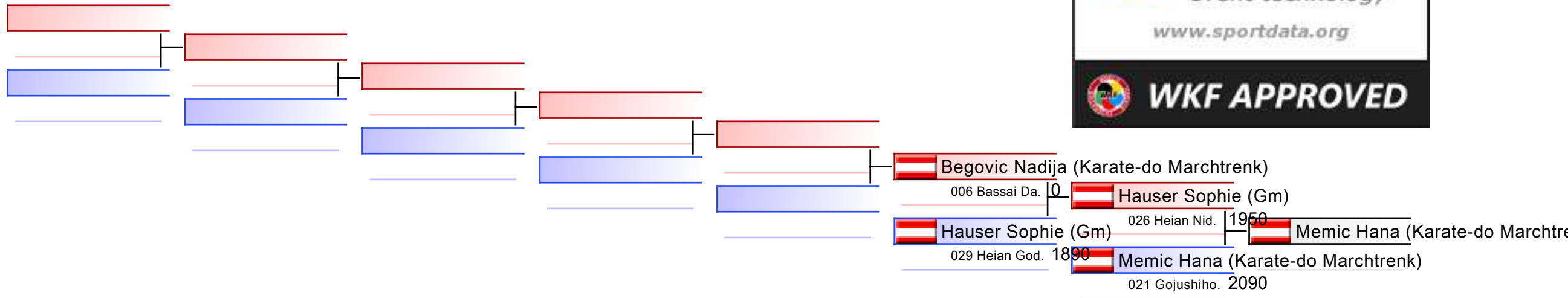

TROSTRUNDE: (1)

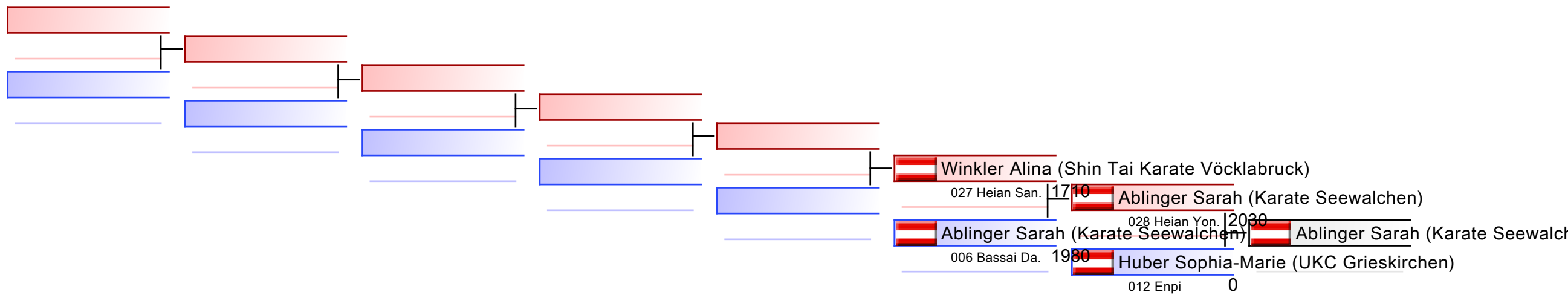









Referees:							
-----------	--	--	--	--	--	--	--



OÖ Landesmeisterschaft und OÖ
Meisterschaft 2024 - 2024-04-13

Offizielle Ergebnisliste





Kata Individual female U16			
1	SAKANOVIC ADNA		AUT - AUSTRIA
2	DINSTL LINDA		AUT - AUSTRIA
3	MEMIC HANA		AUT - AUSTRIA
3	ABLINGER SARAH		AUT - AUSTRIA
5	HAUSER SOPHIE		AUT - AUSTRIA
5	HUBER SOPHIA-MARIE		AUT - AUSTRIA
7	BEGOVIC NADIJA		AUT - AUSTRIA
7	WINKLER ALINA		AUT - AUSTRIA

KATA INDIVIDUAL FEMALE U18



OÖ Landesmeisterschaft und OÖ
Meisterschaft 2024 - 2024-04-13

Offizielle Ergebnisliste

Kata Individual female U18			
1	TREML ANNA		AUT - AUSTRIA
2	GALATEANU EVELYN		AUT - AUSTRIA
3	ISLAMOVIC AJLA		AUT - AUSTRIA
4	GRUDKE LINDA		AUT - AUSTRIA







OÖ Landesmeisterschaft und OÖ
Meisterschaft 2024 - 2024-04-13
Kata Individual female U18

R1 G1/1 (4) Tatami 3 11:10(2024-04-13)

	Teilnehmer	Kata	1	2	3	4	5	6	7	TOTAL	ExtraGesamRang
1	GALATEANU EVELYN (SBK LINZ)	054 MEIKYO	6.9	7.0	(6.5)	(8.5)	6.8			20.7	2
2	GRUDKE LINDA (SHIN TAI KARATE VÖCKLABRUCK)	036 JION	6.3	6.4	(6.0)	(8.0)	6.6			19.3	4
3	ISLAMOVIC AJLA (SBK LINZ)	006 BASSAI DAI	6.8	7.3	6.4	(8.3)	(6.3)			20.5	3
4	TREML ANNA (SPUA)	021 GOJUSHIHO SHO	7.2	7.4	(6.5)	(8.4)	6.8			21.4	1

Results



1	TREML ANNA		AUSTRIA
2	GALATEANU EVELYN		AUSTRIA
3	ISLAMOVIC AJLA		AUSTRIA
4	GRUDKE LINDA		AUSTRIA

KATA INDIVIDUAL FEMALE U21



OÖ Landesmeisterschaft und OÖ
Meisterschaft 2024 - 2024-04-13

Offizielle Ergebnisliste

Kata Individual female U21			
1	JONAS SARAH		AUT - AUSTRIA
2	FEICHTINGER VERONIKA		AUT - AUSTRIA
3	OBEREIGNER ANJA		AUT - AUSTRIA





OÖ Landesmeisterschaft und OÖ
Meisterschaft 2024 - 2024-04-13
Kata Individual female U21

R1 G1/1 (3) Tatami 3 11:40(2024-04-13)

	Teilnehmer	Kata	1	2	3	4	5	6	7	TOTAL	ExtraGesamRang
1	OBEREIGNER ANJA (GM)	006 BASSAI DAI	6.6	(6.3)	6.4	(8.1)	6.4			19.4	19.4 3
2	JONAS SARAH (SHIN TAI KARATE VÖCKLABRUCK)	021 GOJUSHIHO SHO	7.2	7.1	(7.0)	(8.6)	8.1			22.4	22.4 1
3	FEICHTINGER VERONIKA (GM)	040 KANKU DAI	6.8	6.6	(6.0)	(7.9)	7.7			21.1	21.1 2

Results

1	JONAS SARAH		AUSTRIA
2	FEICHTINGER VERONIKA		AUSTRIA
3	OBEREIGNER ANJA		AUSTRIA

KATA INDIVIDUAL MALE SEN+35

Kata Individual male Sen+35

OÖ Landesmeisterschaft und OÖ Meisterschaft 2024, Europaplatz 5, 4663 Laakirchen, AUT

2024-04-13

Tatami

3 09:00

Pool

1/1

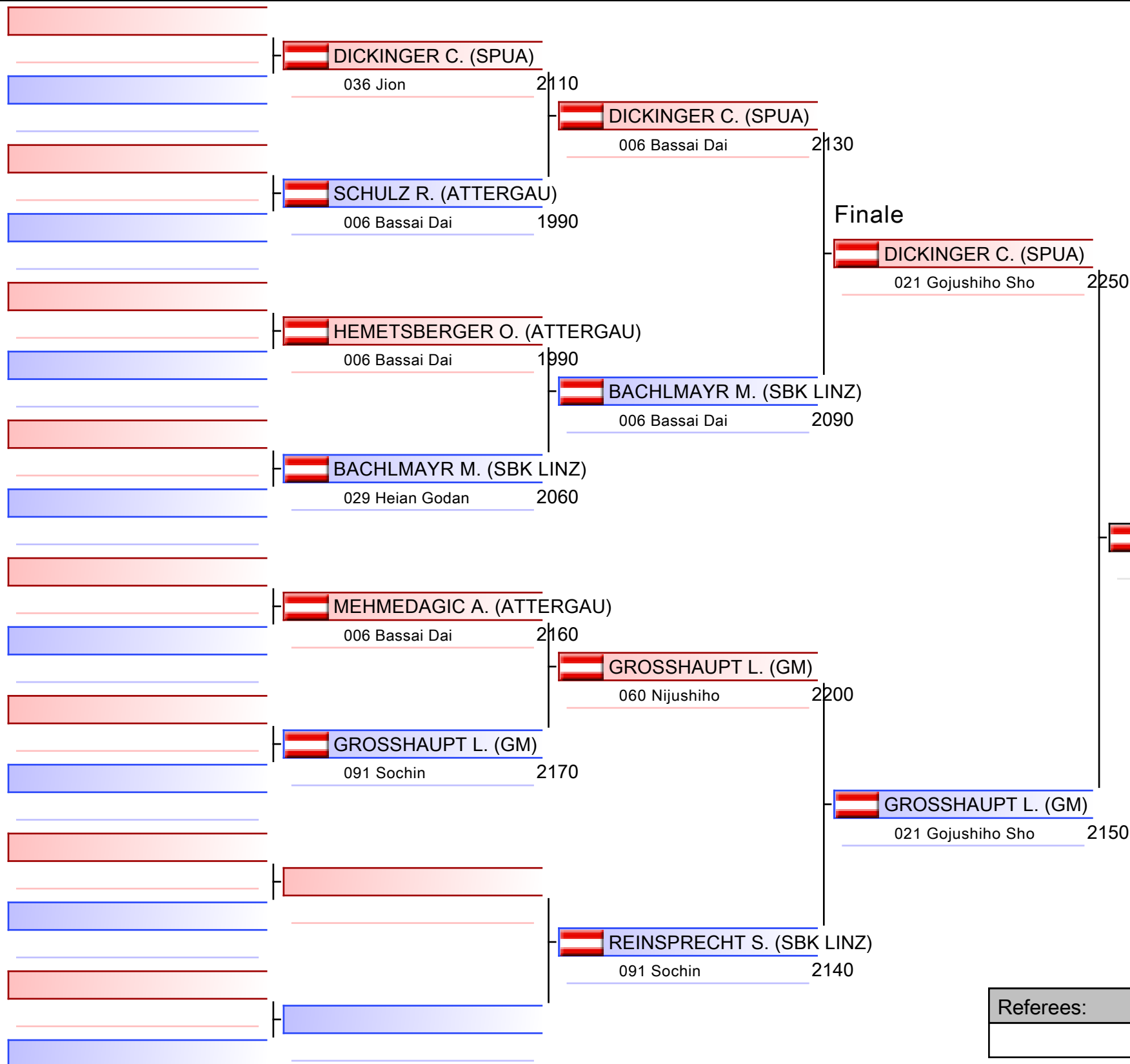

DICKINGER C. (SPUA)

1. DICKINGER CHRISTIAN (SPUA)
2. GROSSHAUPT LUDWIG (GM)
3. BACHLMAYR MICHAEL (SBK LINZ)
3. MEHMEDAGIC AMIR (ATTERGAU)
5. SCHULZ RALPH MARTIN (ATTERGAU)
5. REINSPRECHT STEPHAN (SBK LINZ)

Referees:			

Kata Individual male Sen+35

OÖ Landesmeisterschaft und OÖ Meisterschaft 2024



2024-04-13

Tatami
3 09:00

Pool
1

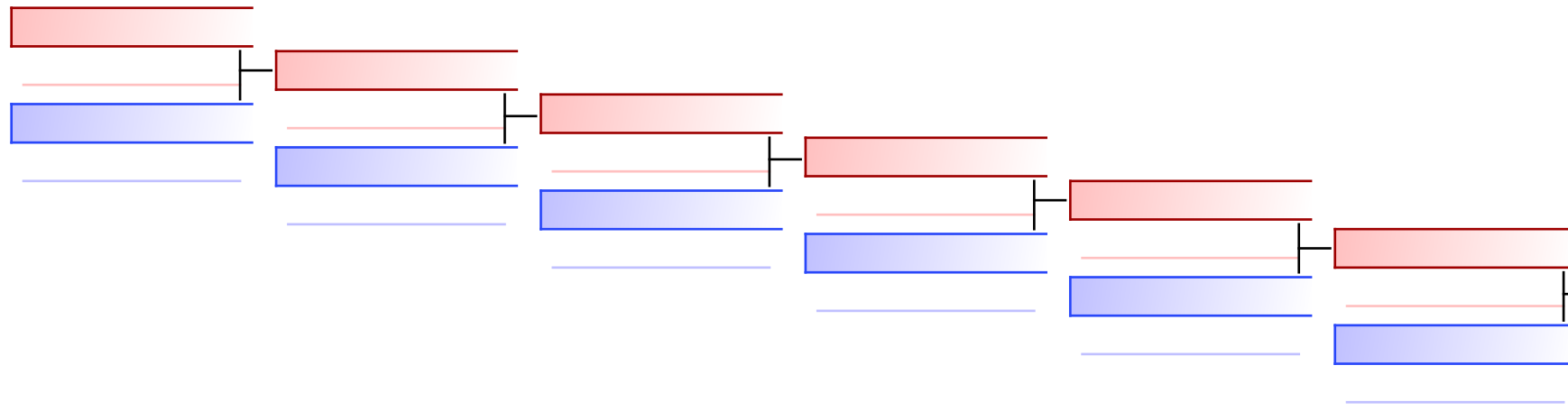

(c)sportdata GmbH & Co KG 2000-2024 (2024-04-14 21:43) v 10.2.0 build 1 (2024-04-06 19:39 CET) Lizenz: SDIL_TV-Graphics (expire 2024-12-31)

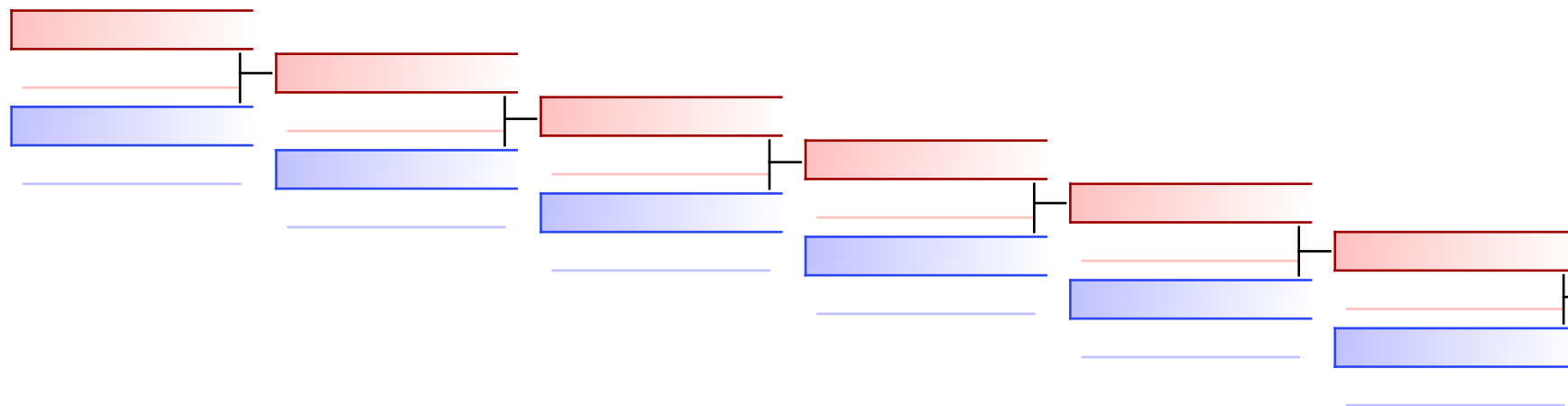

 Schulz Ralph Martin (Attergau)
036 Jion 2030
 Bachlmayr Michael (SBK Linz)
054 Meikyo 2040

TROSTRUNDE: (1)









 Mehmedagic Amir (Attergau)
036 Jion 2110
 Mehmedagic Amir (Attergau)
036 Jion 2110
 Reinsprecht Stephan (SBK Linz)
036 Jion 2110

Referees:							
-----------	--	--	--	--	--	--	--



OÖ Landesmeisterschaft und OÖ
Meisterschaft 2024 - 2024-04-13

Offizielle Ergebnisliste

Kata Individual male Sen+35			
1	DICKINGER CHRISTIAN		AUT - AUSTRIA
2	GROSSHAUPT LUDWIG		AUT - AUSTRIA
3	BACHLMAYR MICHAEL		AUT - AUSTRIA
3	MEHMEDAGIC AMIR		AUT - AUSTRIA
5	SCHULZ RALPH MARTIN		AUT - AUSTRIA
5	REINSPRECHT STEPHAN		AUT - AUSTRIA

KATA INDIVIDUAL MALE SEN +45

Kata Individual male Sen +45

OÖ Landesmeisterschaft und OÖ Meisterschaft 2024, Europaplatz 5, 4663 Laakirchen, AUT

2024-04-13

Tatami

3 10:10

Pool

1/1

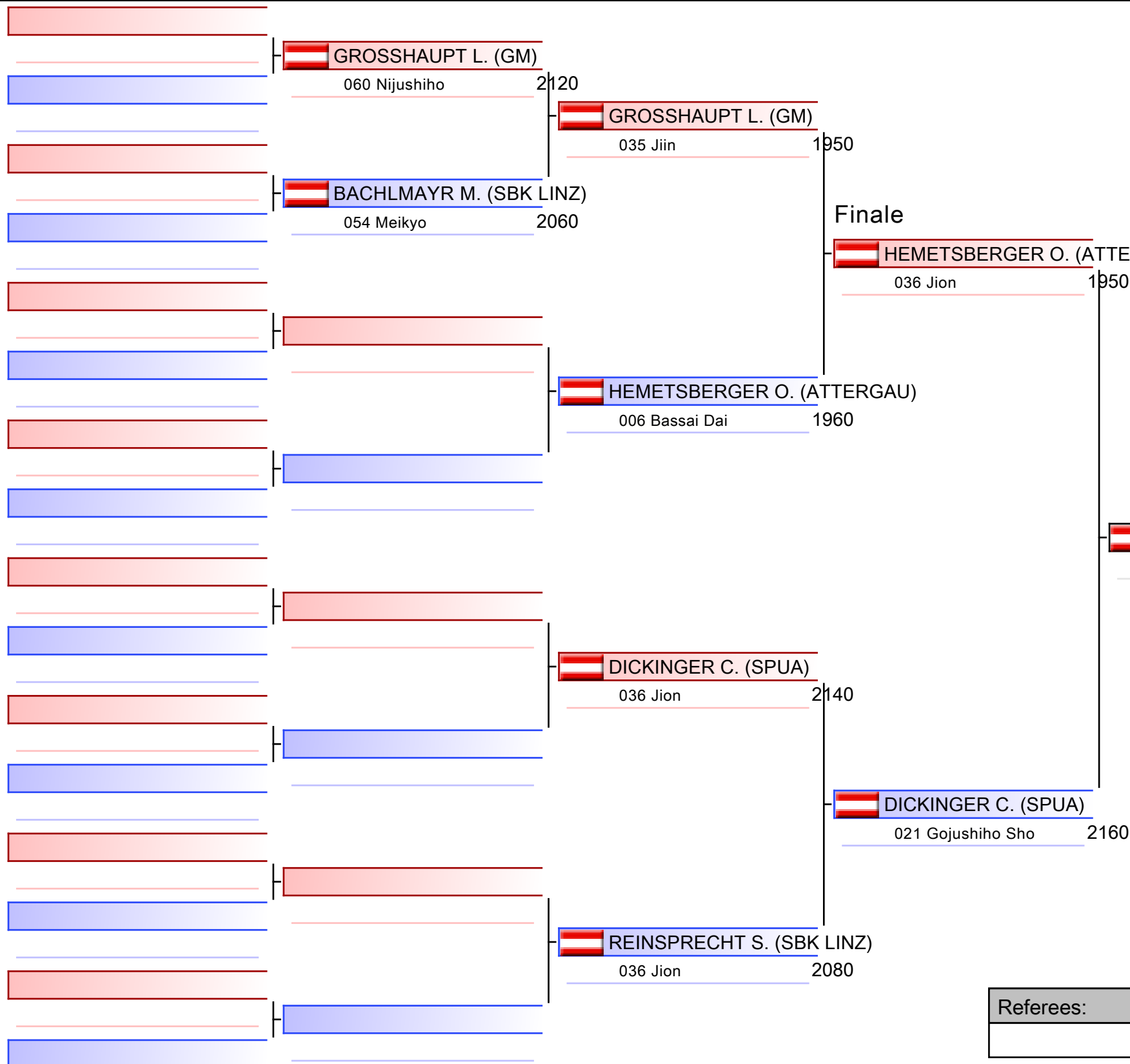

1. DICKINGER CHRISTIAN (SPUA)
2. HEMETSBERGER OSKAR (ATTERGAU)
3. GROSSHAUPT LUDWIG (GM)
3. REINSPRECHT STEPHAN (SBK LINZ)

Referees:			

Kata Individual male Sen +45

OÖ Landesmeisterschaft und OÖ Meisterschaft 2024

2024-04-13

Tatami
3 10:10

Pool
1

(c)sportdata GmbH & Co KG 2000-2024 (2024-04-14 21:43) v 10.2.0 build 1 (2024-04-06 19:39 CET) Lizenz: SDIL_TV-GRAPHICS (expire 2024-12-31)

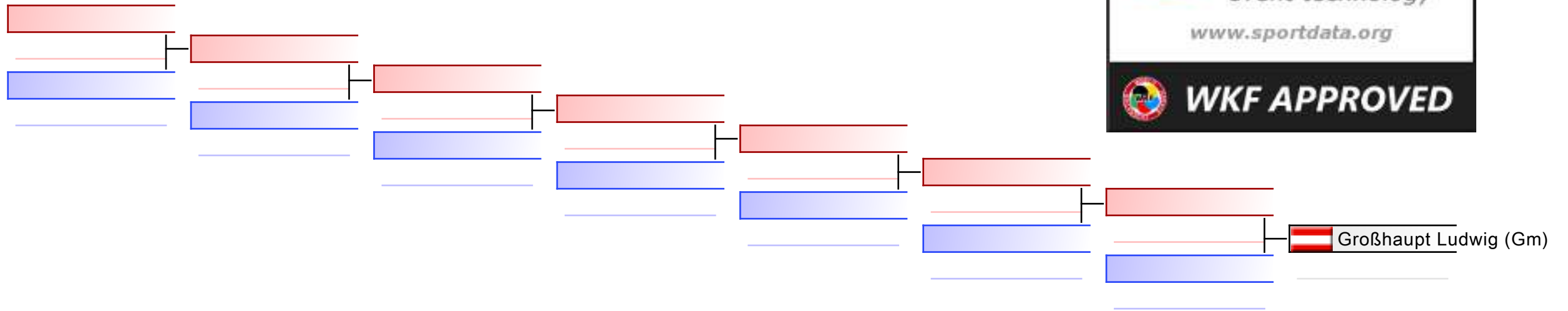

TROSTRUNDE: (1)

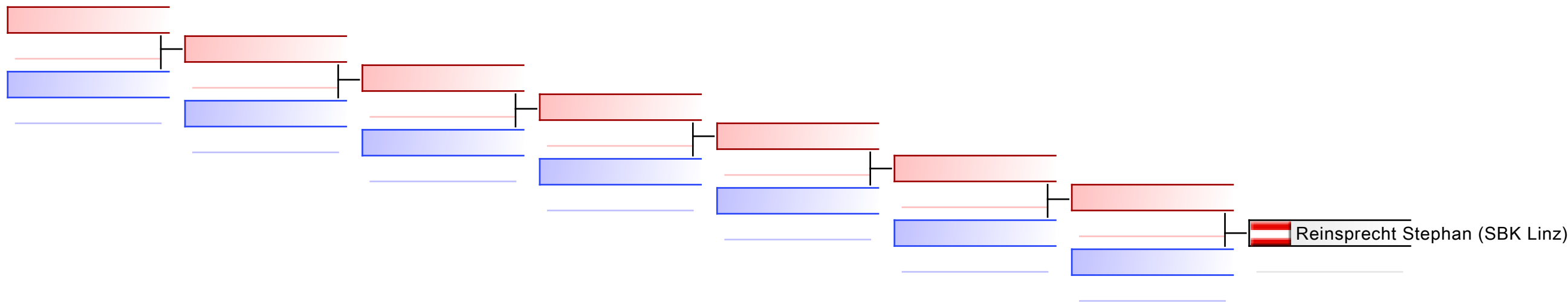





Referees:							
-----------	--	--	--	--	--	--	--



OÖ Landesmeisterschaft und OÖ
Meisterschaft 2024 - 2024-04-13

Offizielle Ergebnisliste

Kata Individual male Sen +45			
1	DICKINGER CHRISTIAN		AUT - AUSTRIA
2	HEMETSBERGER OSKAR		AUT - AUSTRIA
3	GROSSHAUPT LUDWIG		AUT - AUSTRIA
3	REINSPRECHT STEPHAN		AUT - AUSTRIA

KATA INDIVIDUAL MALE SENIORS

Kata Individual male Seniors

OÖ Landesmeisterschaft und OÖ Meisterschaft 2024, Europaplatz 5, 4663 Laakirchen, AUT

2024-04-13

Tatami

3 15:30

Pool

1/1

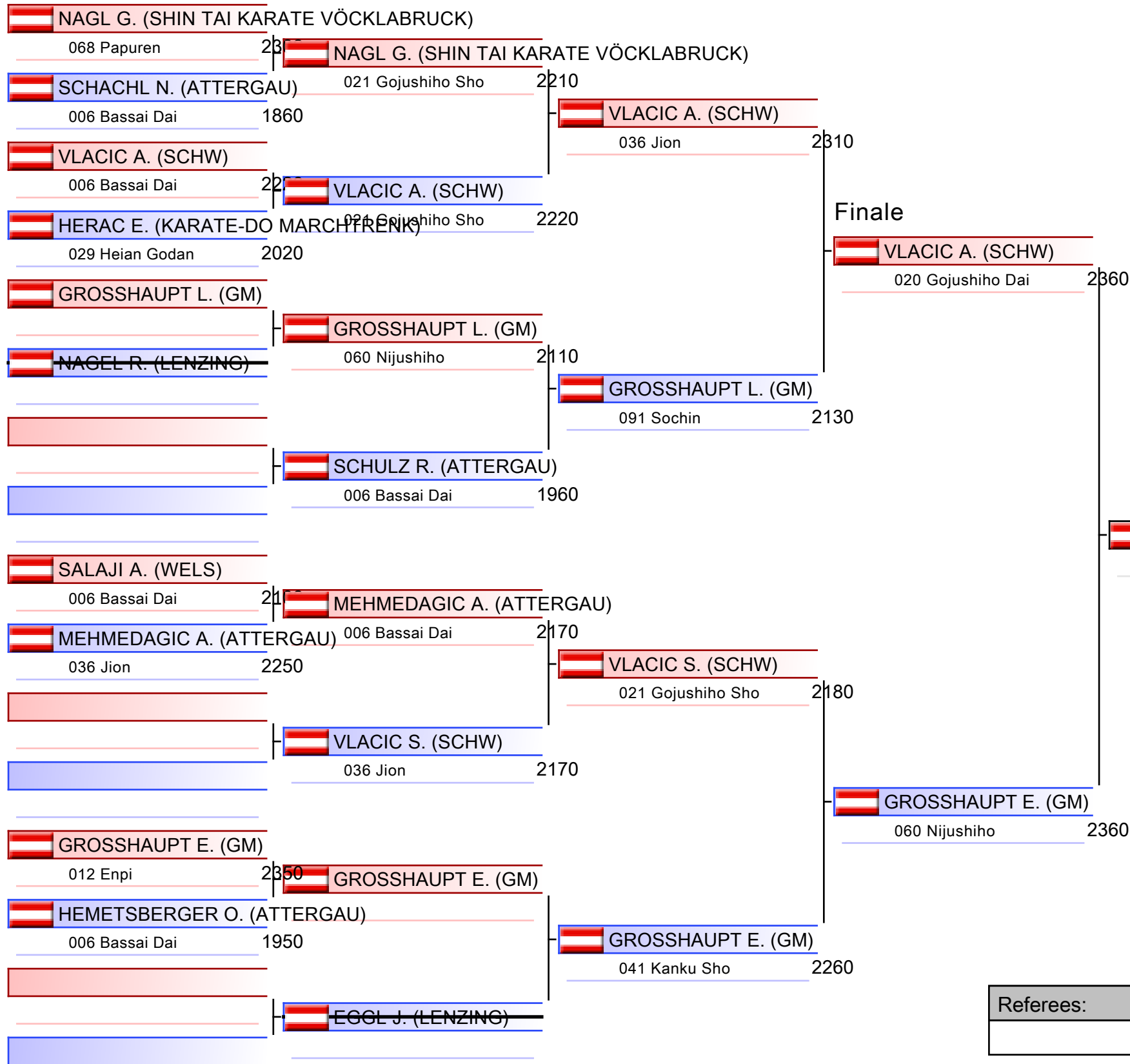

- | |
|--|
| 1. VLACIC ALEKSANDAR (SCHW) |
| 2. GROSSHAUPT ERIK (GM) |
| 3. VLACIC STEFAN (SCHW) |
| 3. NAGL GREGOR (SHIN TAI KARATE VÖCKLABRUCK) |
| 5. HEMETSBERGER OSKAR (ATTERGAU) |
| 5. GROSSHAUPT LUDWIG (GM) |
| 7. HERAC EDVIN (KARATE-DO MARCHTRENK) |
| |

Referees:			

Kata Individual male Seniors

OÖ Landesmeisterschaft und OÖ Meisterschaft 2024

2024-04-13

Tatami
3 15:30

Pool
1

(c)sportdata GmbH & Co KG 2000-2024 (2024-04-14 21:43) v 10.2.0 build 1 (2024-04-06 19:39 CET) Lizenz: SDIL_TV-GRAPHICS (expire 2024-12-31)

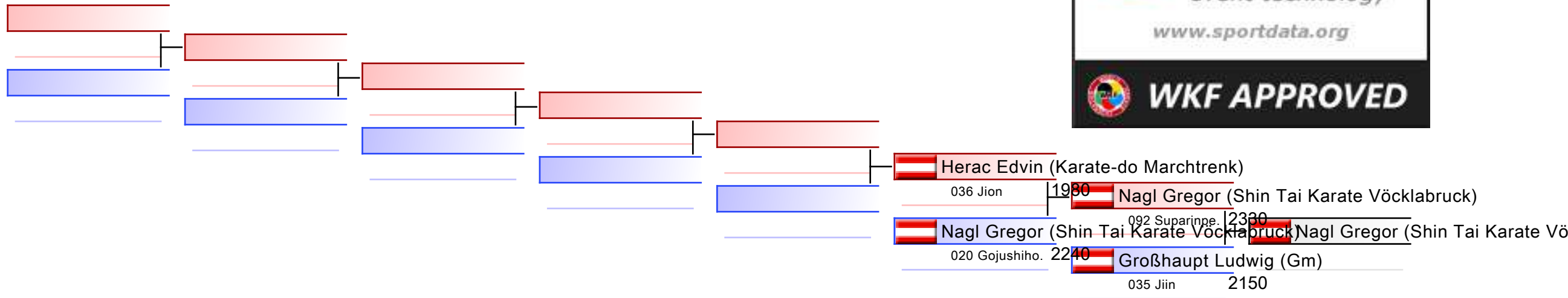

TROSTRUNDE: (1)

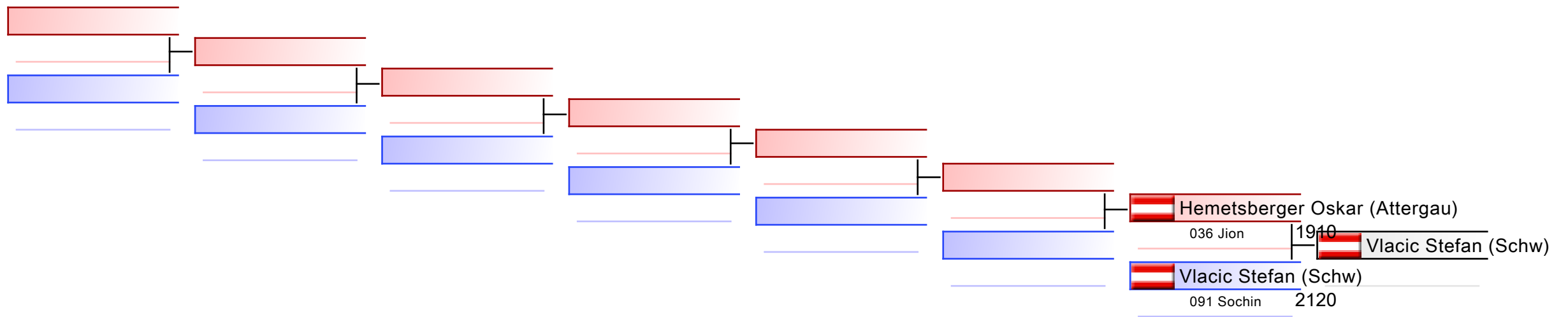







Referees:							
-----------	--	--	--	--	--	--	--



OÖ Landesmeisterschaft und OÖ
Meisterschaft 2024 - 2024-04-13

Offizielle Ergebnisliste

Kata Individual male Seniors			
1	VLACIC ALEKSANDAR		AUT - AUSTRIA
2	GROSSHAUPT ERIK		AUT - AUSTRIA
3	VLACIC STEFAN		AUT - AUSTRIA
3	NAGL GREGOR		AUT - AUSTRIA
5	HEMETSBERGER OSKAR		AUT - AUSTRIA
5	GROSSHAUPT LUDWIG		AUT - AUSTRIA
7	HERAC EDVIN		AUT - AUSTRIA

KATA INDIVIDUAL MALE U10

Kata Individual male U10

OÖ Landesmeisterschaft und OÖ Meisterschaft 2024, Europaplatz 5, 4663 Laakirchen, AUT

2024-04-13

Tatami
2 09:00

Pool
1/1

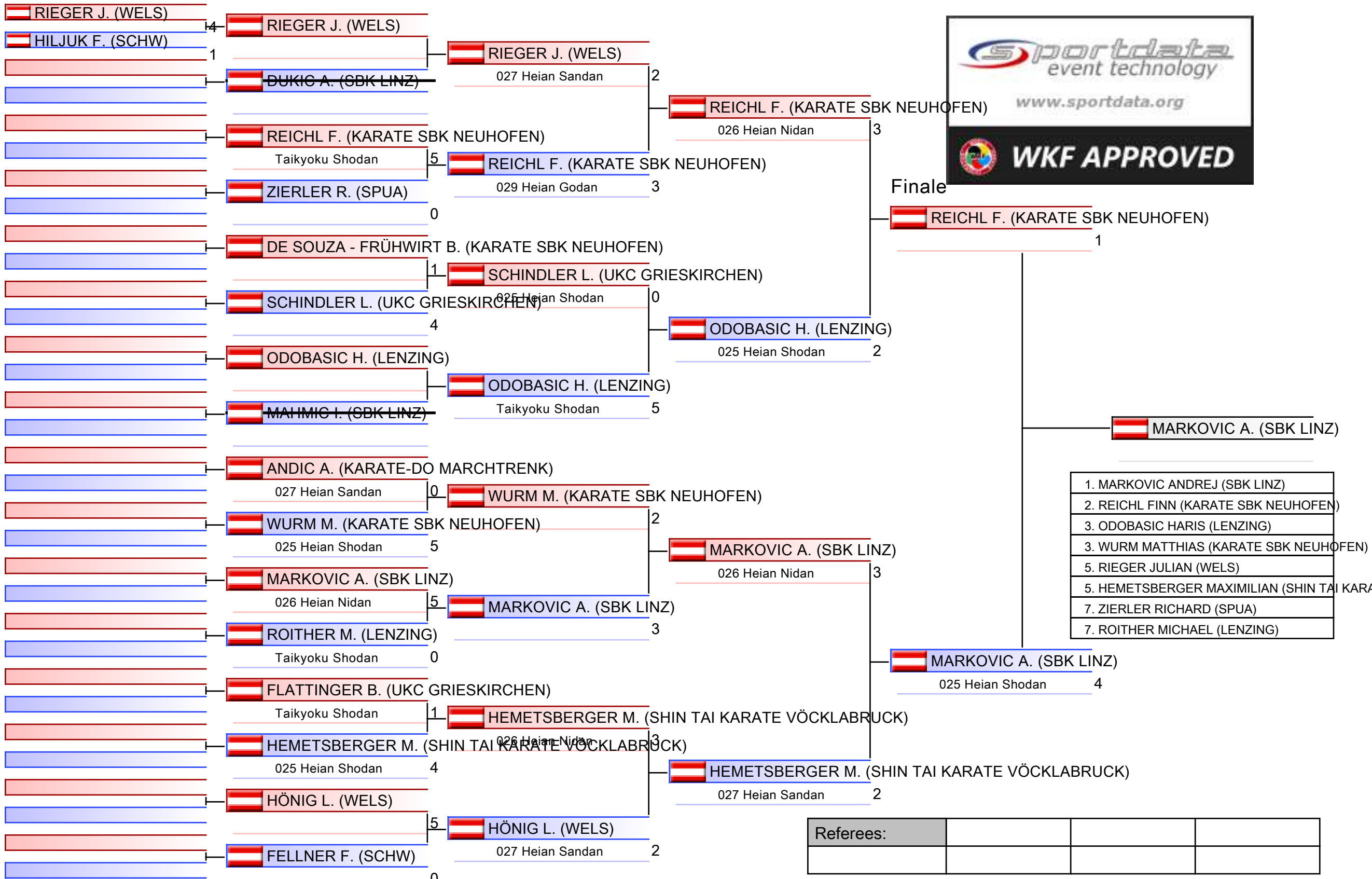

- | |
|--|
| 1. MARKOVIC ANDREJ (SBK LINZ) |
| 2. REICHL FINN (KARATE SBK NEUHOFEN) |
| 3. ODOBASIC HARIS (LENZING) |
| 3. WURM MATTHIAS (KARATE SBK NEUHOFEN) |
| 5. RIEGER JULIAN (WELS) |
| 5. HEMETSBERGER MAXIMILIAN (SHIN TAI KARATE VÖCKLABRUCK) |
| 7. ZIERLER RICHARD (SPUA) |
| 7. ROITHER MICHAEL (LENZING) |

Kata Individual male U10

OÖ Landesmeisterschaft und OÖ Meisterschaft 2024

2024-04-13

Tatami
2 09:00

Pool
1

(c)sportdata GmbH & Co KG 2000-2024 (2024-04-14 21:43) v 10.2.0 build 1 (2024-04-06 19:39 CET) Lizenz: SDIL_TV-GRAPHICS (expire 2024-12-31)

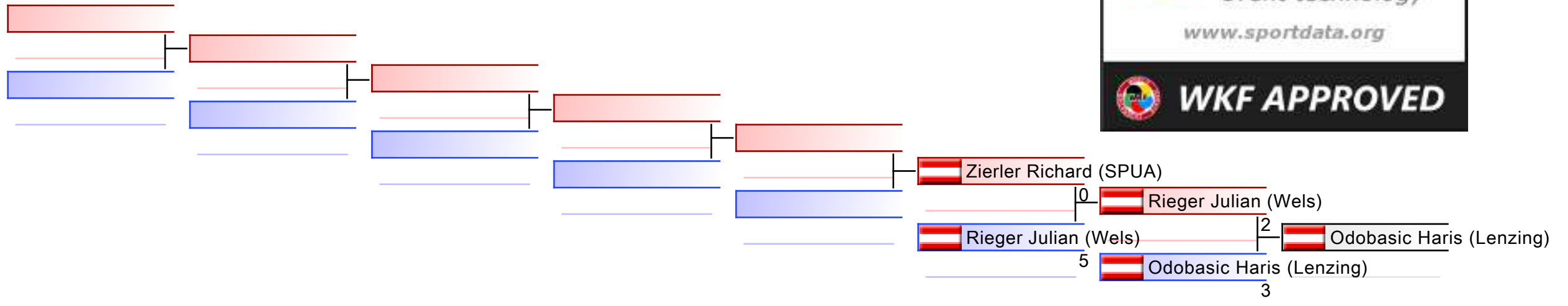

TROSTRUNDE: (1)

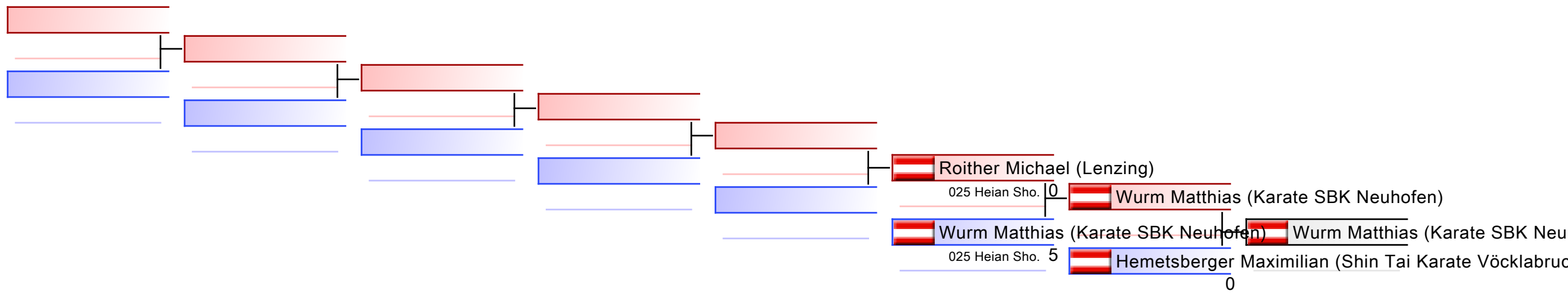









Referees:							
-----------	--	--	--	--	--	--	--



OÖ Landesmeisterschaft und OÖ
Meisterschaft 2024 - 2024-04-13

Offizielle Ergebnisliste

Kata Individual male U10			
1	MARKOVIC ANDREJ		AUT - AUSTRIA
2	REICHL FINN		AUT - AUSTRIA
3	ODOBASIC HARIS		AUT - AUSTRIA
3	WURM MATTHIAS		AUT - AUSTRIA
5	RIEGER JULIAN		AUT - AUSTRIA
5	HEMETSBERGER MAXIMILIAN		AUT - AUSTRIA
7	ZIERLER RICHARD		AUT - AUSTRIA
7	ROITHER MICHAEL		AUT - AUSTRIA

KATA INDIVIDUAL MALE U12

Kata Individual male U12

OÖ Landesmeisterschaft und OÖ Meisterschaft 2024, Europaplatz 5, 4663 Laakirchen, AUT

2024-04-13

Tatami

2 09:30

Pool

1/1

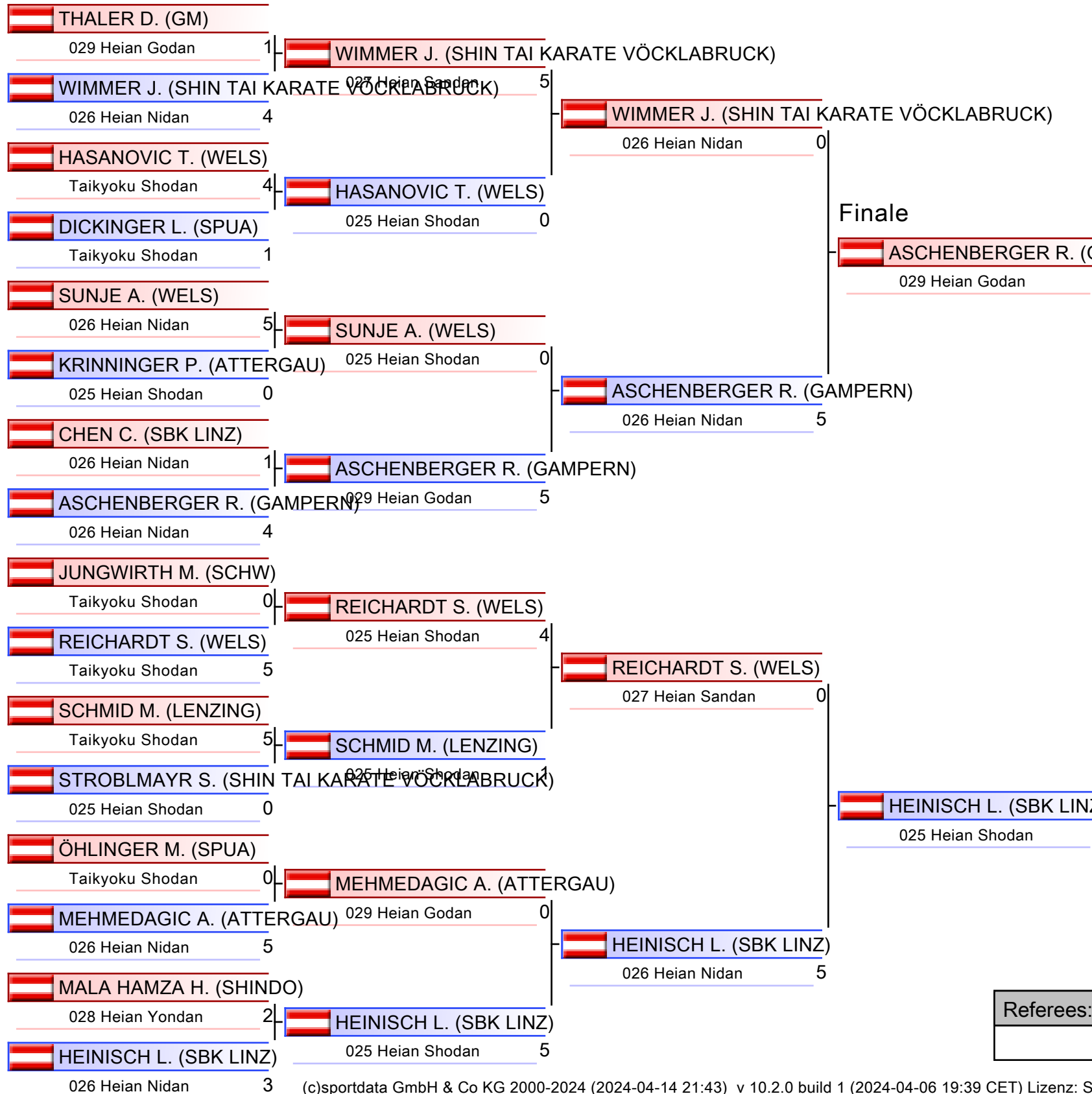

1. HEINISCH LEON (SBK LINZ)
2. ASCHENBERGER RAPHAEL (GAMPERN)
3. CHEN CHENKAI (SBK LINZ)
3. MALA HAMZA HEM (SHINDO)
5. WIMMER JONAS (SHIN TAI KARATE VÖCKLABRUCK)
5. REICHARDT SIMON (WELS)
7. SUNJE ADRIANO (WELS)
7. MEHMEDAGIC ANES (ATTERGAU)

Referees:			

Kata Individual male U12

OÖ Landesmeisterschaft und OÖ Meisterschaft 2024

2024-04-13

Tatami
2 09:30

Pool
1

(c)sportdata GmbH & Co KG 2000-2024 (2024-04-14 21:43) v 10.2.0 build 1 (2024-04-06 19:39 CET) Lizenz: SDIL_TV-Graphics (expire 2024-12-31)

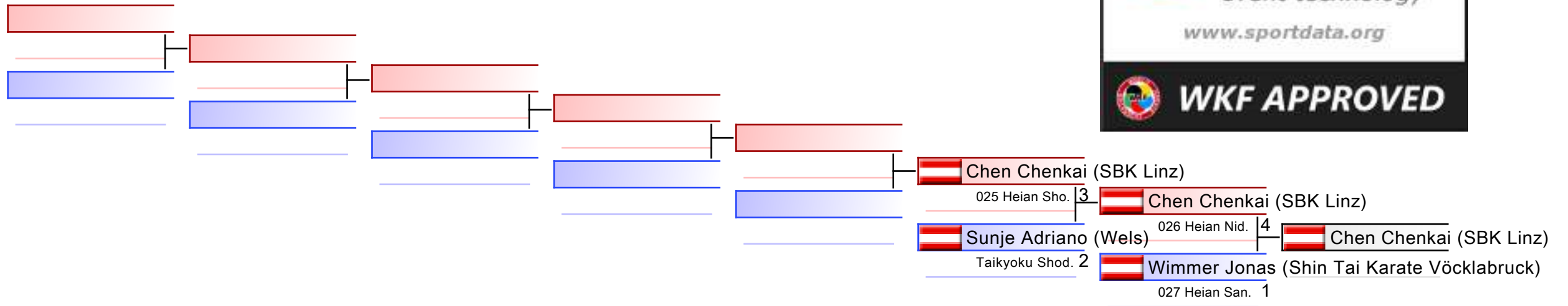

TROSTRUNDE: (1)

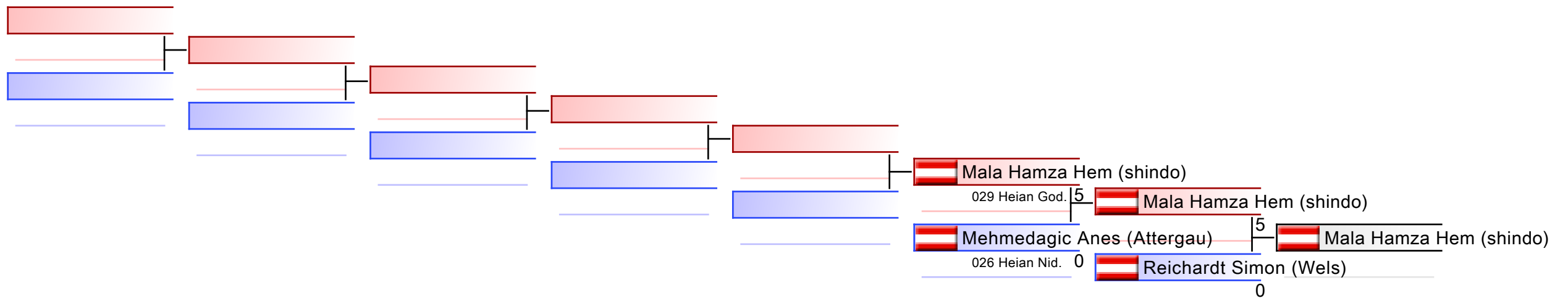









Referees:							
-----------	--	--	--	--	--	--	--



OÖ Landesmeisterschaft und OÖ
Meisterschaft 2024 - 2024-04-13

Offizielle Ergebnisliste

Kata Individual male U12			
1	HEINISCH LEON		AUT - AUSTRIA
2	ASCHENBERGER RAPHAEL		AUT - AUSTRIA
3	CHEN CHENKAI		AUT - AUSTRIA
3	MALA HAMZA HEM		AUT - AUSTRIA
5	WIMMER JONAS		AUT - AUSTRIA
5	REICHARDT SIMON		AUT - AUSTRIA
7	SUNJE ADRIANO		AUT - AUSTRIA
7	MEHMEDAGIC ANES		AUT - AUSTRIA

KATA INDIVIDUAL MALE U14

Kata Individual male U14

OÖ Landesmeisterschaft und OÖ Meisterschaft 2024

2024-04-13

Tatami
2 10:00

Pool
1

(c)sportdata GmbH & Co KG 2000-2024 (2024-04-14 21:43) v 10.2.0 build 1 (2024-04-06 19:39 CET) Lizenz: SDIL_TV-Graphics (expire 2024-12-31)

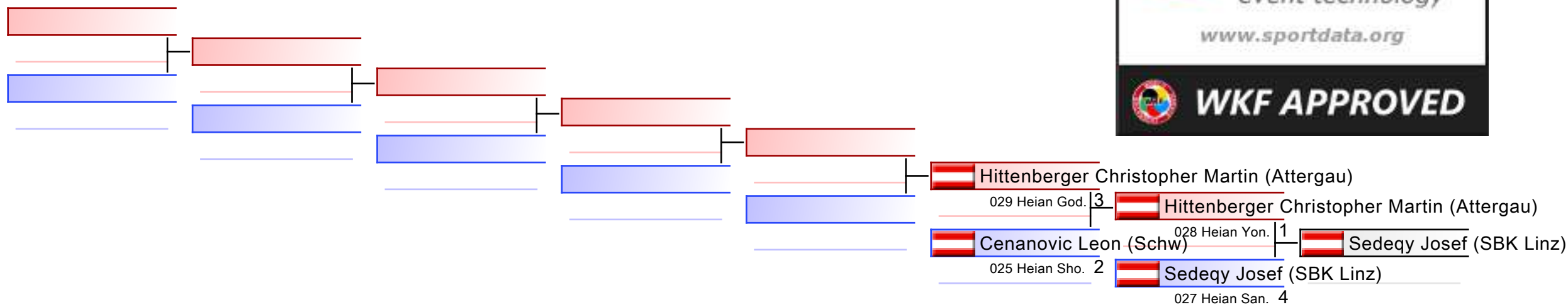

TROSTRUNDE: (1)

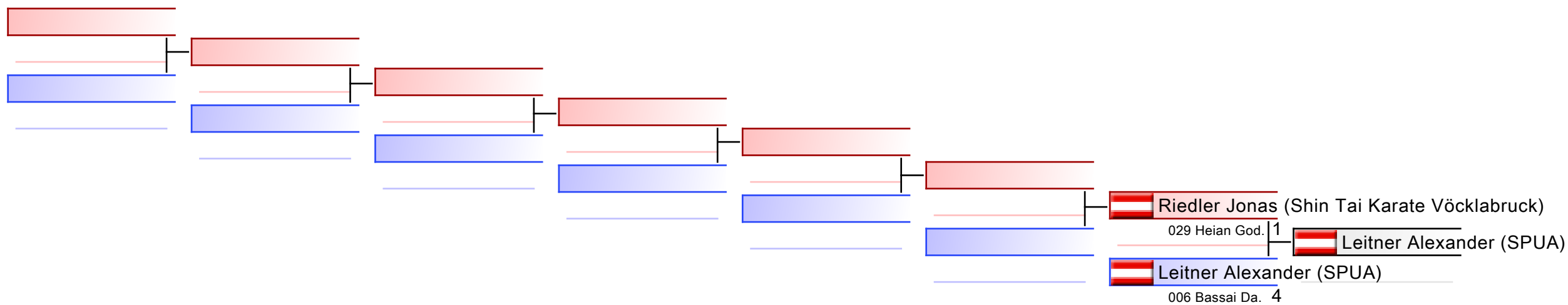

Referees:							
-----------	--	--	--	--	--	--	--



OÖ Landesmeisterschaft und OÖ
Meisterschaft 2024 - 2024-04-13

Offizielle Ergebnisliste

Kata Individual male U14			
1	TRUMIC AHMED		AUT - AUSTRIA
2	GADERER JULIAN		AUT - AUSTRIA
3	LEITNER ALEXANDER		AUT - AUSTRIA
3	SEDEQY JOSEF		AUT - AUSTRIA
5	RIEDLER JONAS		AUT - AUSTRIA
5	HITTENBERGER CHRISTOPHER MARTIN		AUT - AUSTRIA
7	CENANOVIC LEON		AUT - AUSTRIA

KATA INDIVIDUAL MALE U16

Kata Individual male U16

OÖ Landesmeisterschaft und OÖ Meisterschaft 2024, Europaplatz 5, 4663 Laakirchen, AUT

2024-04-13

Tatami
2 10:25

Pool
1/1

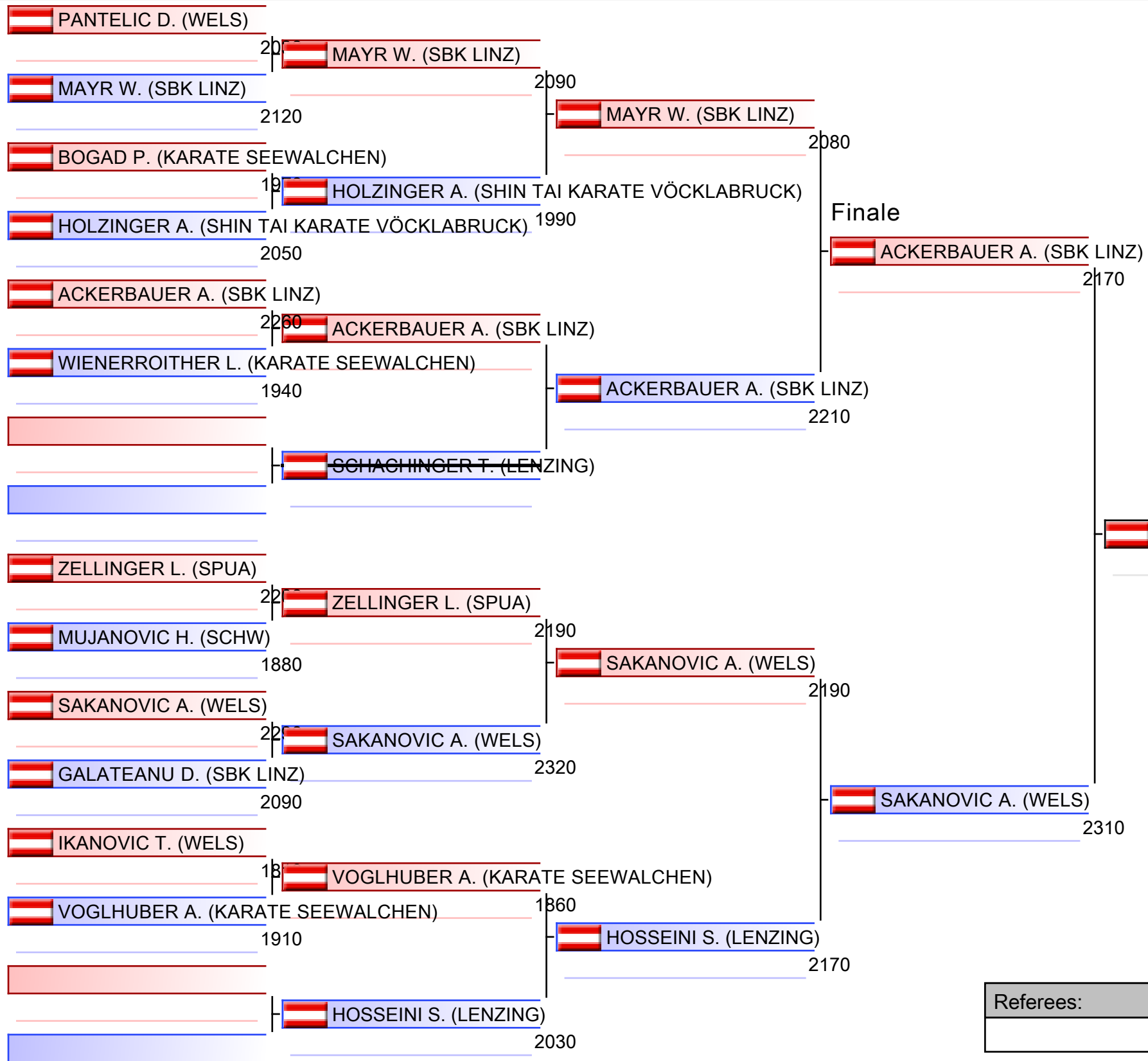

1. SAKANOVIC ADIN (WELS)
2. ACKERBAUER ANDREAS (SBK LINZ)
3. MAYR WERNER (SBK LINZ)
3. HOSSEINI SARO (LENZING)
5. WIENERROITHER LUKAS (KARATE SEEWALCHEN)
5. ZELLINGER LEON (SPUA)
7. GALATEANU DAVID (SBK LINZ)

Referees:			

Kata Individual male U16

OÖ Landesmeisterschaft und OÖ Meisterschaft 2024

2024-04-13

Tatami
2 10:25

Pool
1

(c)sportdata GmbH & Co KG 2000-2024 (2024-04-14 21:44) v 10.2.0 build 1 (2024-04-06 19:39 CET) Lizenz: SDIL_TV-Graphics (expire 2024-12-31)

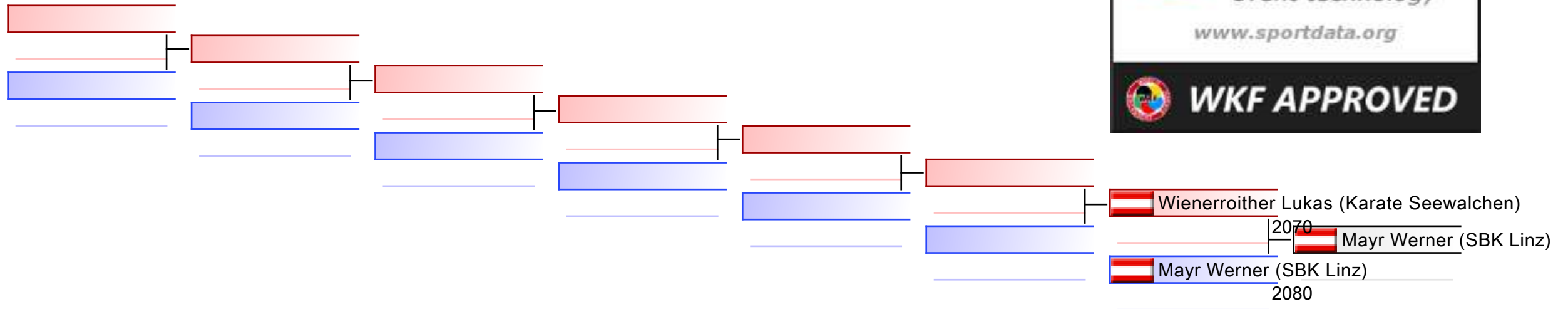

TROSTRUNDE: (1)

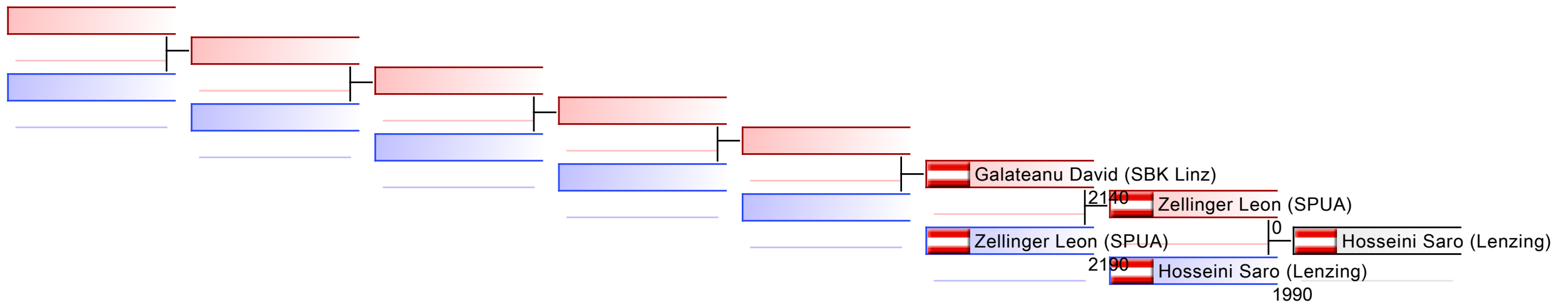







Referees:							
-----------	--	--	--	--	--	--	--



OÖ Landesmeisterschaft und OÖ
Meisterschaft 2024 - 2024-04-13

Offizielle Ergebnisliste

Kata Individual male U16			
1	SAKANOVIC ADIN		AUT - AUSTRIA
2	ACKERBAUER ANDREAS		AUT - AUSTRIA
3	MAYR WERNER		AUT - AUSTRIA
3	HOSSEINI SARO		AUT - AUSTRIA
5	WIENERROITHER LUKAS		AUT - AUSTRIA
5	ZELLINGER LEON		AUT - AUSTRIA
7	GALATEANU DAVID		AUT - AUSTRIA

KATA INDIVIDUAL MALE U21

Kata Individual male U21

OÖ Landesmeisterschaft und OÖ Meisterschaft 2024, Europaplatz 5, 4663 Laakirchen, AUT

2024-04-13

Tatami

2 11:35

Pool

1/1

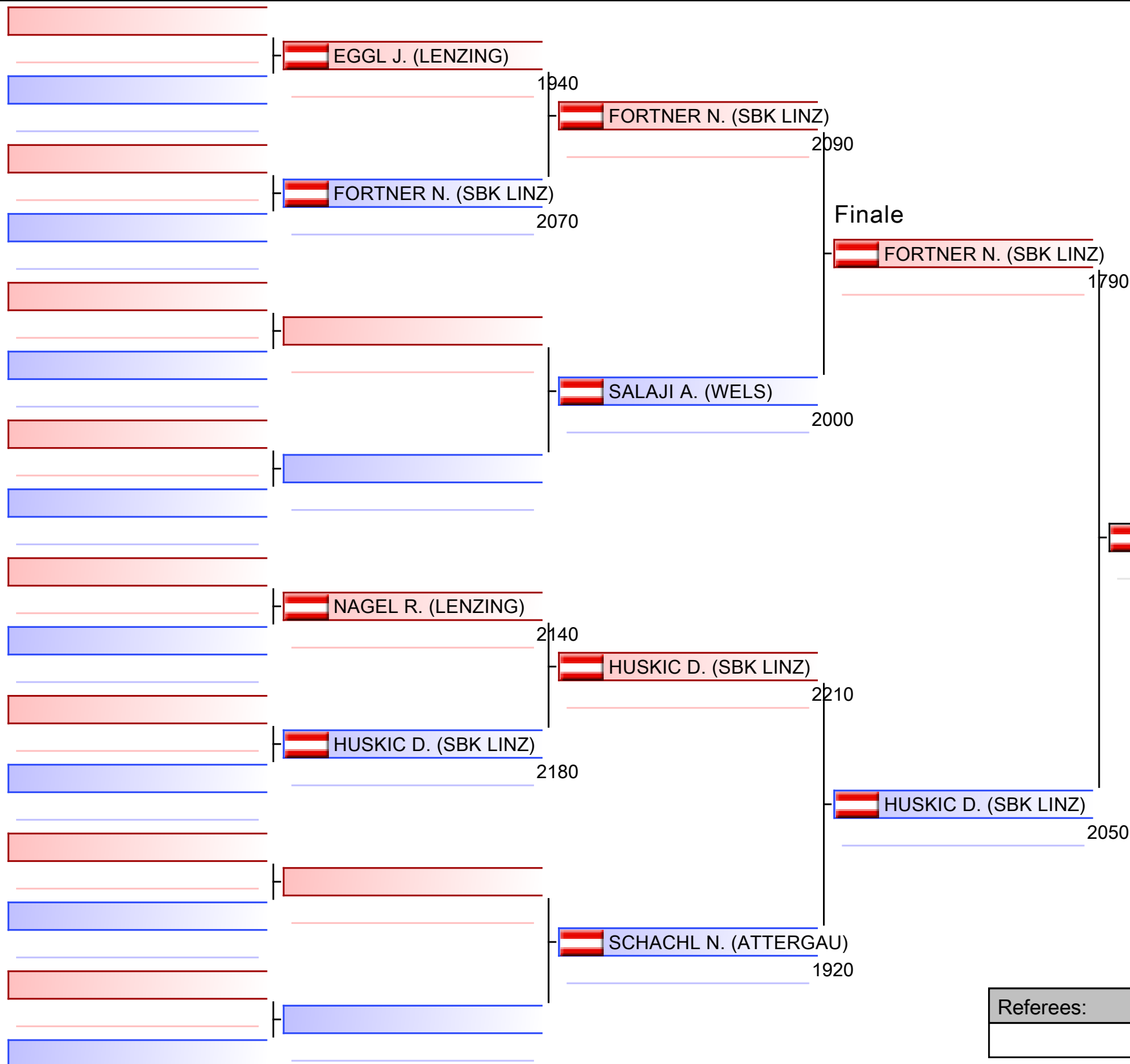

1. HUSKIC DENIS (SBK LINZ)
2. FORTNER NIKLAS (SBK LINZ)
3. SALAJI ARGJENT (WELS)
3. NAGEL RAPHAEL (LENZING)
5. EGGL JOHANNES (LENZING)
5. SCHACHL NIKLAS (ATTERGAU)

Referees:			

Kata Individual male U21

OÖ Landesmeisterschaft und OÖ Meisterschaft 2024

2024-04-13

Tatami
2 11:35

Pool
1

(c)sportdata GmbH & Co KG 2000-2024 (2024-04-14 21:44) v 10.2.0 build 1 (2024-04-06 19:39 CET) Lizenz: SDIL_TV-GRAPHICS (expire 2024-12-31)

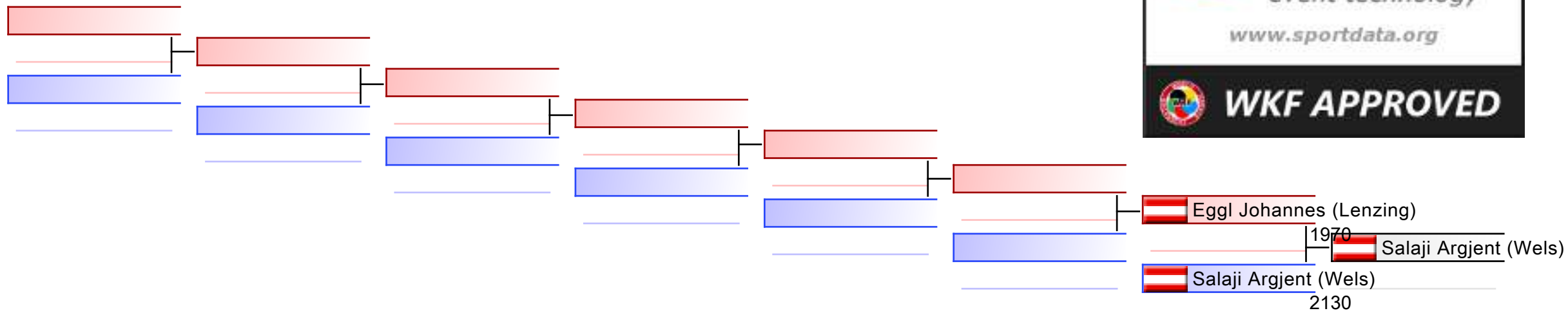

TROSTRUNDE: (1)

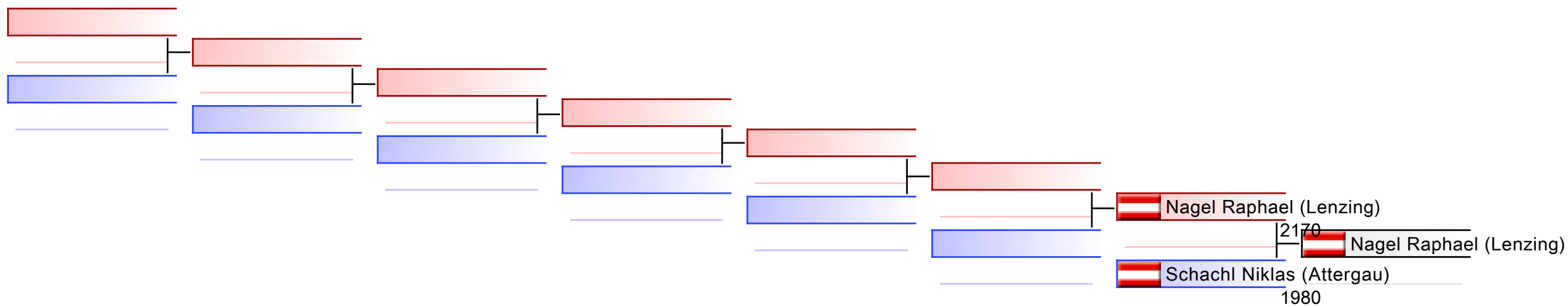







Referees:							
-----------	--	--	--	--	--	--	--



OÖ Landesmeisterschaft und OÖ
Meisterschaft 2024 - 2024-04-13

Offizielle Ergebnisliste



Kata Individual male U21			
1	HUSKIC DENIS		AUT - AUSTRIA
2	FORTNER NIKLAS		AUT - AUSTRIA
3	SALAJI ARGJENT		AUT - AUSTRIA
3	NAGEL RAPHAEL		AUT - AUSTRIA
5	EGGL JOHANNES		AUT - AUSTRIA
5	SCHACHL NIKLAS		AUT - AUSTRIA

KATA TEAM FEMALE SENIORS



OÖ Landesmeisterschaft und OÖ
Meisterschaft 2024 - 2024-04-13

Offizielle Ergebnisliste

Kata Team female Seniors			
1	ASKÖ SEIBUKAN LINZ TEAM 3 - BERISHA NATALIE - FUCHS ANNA - STICHT PATRICIA		AUT - AUSTRIA
2	SPORTUNION KARATE GMUNDEN - AICHSTILL DESIREE - GRILL MELANIE - OBEREIGNER ANJA		AUT - AUSTRIA
3	ATSV SEEWALCHEN - SEKTION KARATE - ABLINGER BIRGIT - KOPACKA-RIEDL KIM - ZEILBERGER ELKE		AUT - AUSTRIA





OÖ Landesmeisterschaft und OÖ
Meisterschaft 2024 - 2024-04-13
Kata Team female Seniors

R1 G1/1 (3) Tatami 2 16:25(2024-04-13)

Teilnehmer	Kata	1	2	3	4	5	6	7	TOTAL	ExtraGesamRang
1 ASKÖ SEIBUKAN LINZ TEAM 3 (BERISHA, FUCHS, STICHT) (SBK LINZ)		(9.0)	(9.0)	9.0	9.0	9.0			27.0	27.0 1
2 ATSV SEEWALCHEN - SEKTION KARATE (ABLINGER, KOPACKA- RIEDL, ZEILBERGER) (KARATE SEEWALCHEN)		(7.0)	(7.0)	7.0	7.0	7.0			21.0	21.0 3
3 SPORTUNION KARATE GMUNDEN (AICHSTILL, GRILL, OBEREIGNER) (GM)		(8.0)	(8.0)	8.0	8.0	8.0			24.0	24.0 2

Results

1 ASKÖ SEIBUKAN LINZ TEAM 3 - BERISHA NATALIE - FUCHS ANNA - STICHT PATRICIA		AUSTRIA
2 SPORTUNION KARATE GMUNDEN - AICHSTILL DESIREE - GRILL MELANIE - OBEREIGNER ANJA		AUSTRIA
3 ATSV SEEWALCHEN - SEKTION KARATE - ABLINGER BIRGIT - KOPACKA-RIEDL KIM - ZEILBERGER ELKE		AUSTRIA

KATA TEAM FEMALE U12



OÖ Landesmeisterschaft und OÖ
Meisterschaft 2024 - 2024-04-13

Offizielle Ergebnisliste

Kata Team female U12			
1	ASKÖ SEIBUKAN LINZ - HUSKIC DIANA - ISLAMOVIĆ EMIRA - MITRI JENNIFER - MÖRIBAUER LEILA		AUT - AUSTRIA
2	ASKÖ SEIBUKAN LINZ - CAUSEVIC MELEK_EIWA - NOORI LENIA - TRAN LEONIE		AUT - AUSTRIA
3	ATSV LENZING SEKTION KARATE 1 - NEUDORFER ELLA - ROITHER MIA - SEEBAUER FRANZISKA		AUT - AUSTRIA
4	SHIN TAI KARATE VÖCKLABRUCK 3 - BEKAS ARYANA - HACKL LIESELOTTE - PEHLIC ALISA		AUT - AUSTRIA







OÖ Landesmeisterschaft und OÖ
Meisterschaft 2024 - 2024-04-13

Kata Team female U12

R1 G1/1 (4) Tatami 3 10:45(2024-04-13)

Teilnehmer	Kata	1	2	3	4	5	6	7	TOTAL	ExtraGesamRang
1 SHIN TAI KARATE VÖCKLABRUCK 3 (BEKAS, HACKL, PEHLIC) (SHIN TAI KARATE VÖCKLABRUCK)	025 HEIAN SHODAN	(6.0)	6.0	6.0	(7.0)	7.0			19.0	19.0 4
2 ATSV LENZING SEKTION KARATE 1 (NEUDORFER, ROITHER, SEEBAUER) (LENZING)	TAIKYOKU SHODAN	(8.0)	7.0	7.0	(6.0)	8.0			22.0	22.0 3
3 ASKÖ SEIBUKAN LINZ (CAUSEVIC, NOORI, TRAN) (SBK LINZ)	026 HEIAN NIDAN	(9.0)	8.2	9.0	(8.0)	9.0			26.2	26.2 2
4 ASKÖ SEIBUKAN LINZ (HUSKIC, ISLAMOVIC, MITRI, MÖRIXBAUER) (SBK LINZ)	026 HEIAN NIDAN	(10.0)	9.0	(8.0)	9.0	9.0			27.0	27.0 1

Results

1	ASKÖ SEIBUKAN LINZ - HUSKIC DIANA - ISLAMOVIC EMIRA - MITRI JENNIFER - MÖRIXBAUER LEILA		AUSTRIA
2	ASKÖ SEIBUKAN LINZ - CAUSEVIC MELEK_EIWA - NOORI LENIA - TRAN LEONIE		AUSTRIA
3	ATSV LENZING SEKTION KARATE 1 - NEUDORFER ELLA - ROITHER MIA - SEEBAUER FRANZISKA		AUSTRIA
4	SHIN TAI KARATE VÖCKLABRUCK 3 - BEKAS ARYANA - HACKL LIESELOTTE - PEHLIC ALISA		AUSTRIA

KATA TEAM FEMALE U16

Kata Team female U16

OÖ Landesmeisterschaft und OÖ Meisterschaft 2024, Europaplatz 5, 4663 Laakirchen, AUT

2024-04-13

Tatami
1 12:00

Pool
1/1

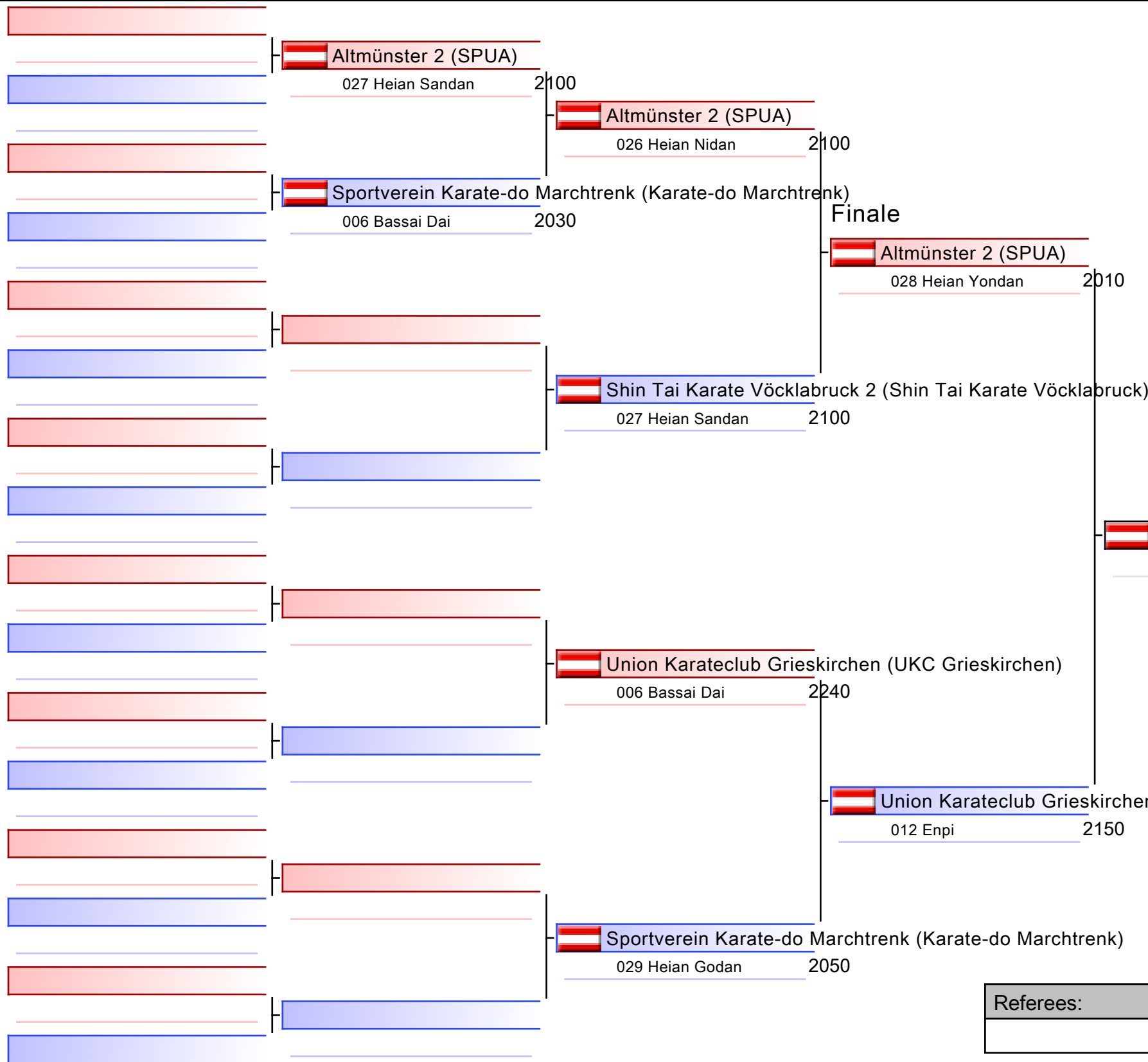

1. UNION KARATECLUB GRIESKIRCHEN (UKC GRIE
2. ALTMÜNSTER 2 (SPUA)
3. SPORTVEREIN KARATE-DO MARCHTRENK (KA
3. SHIN TAI KARATE VÖCKLABRUCK 2 (SHIN TAI
5. SPORTVEREIN KARATE-DO MARCHTRENK (KA

Referees:			

Kata Team female U16

OÖ Landesmeisterschaft und OÖ Meisterschaft 2024

2024-04-13

Tatami
1 12:00

Pool
1

(c)sportdata GmbH & Co KG 2000-2024 (2024-04-14 21:44) v 10.2.0 build 1 (2024-04-06 19:39 CET) Lizenz: SDIL_TV-GRAPHICS (expire 2024-12-31)

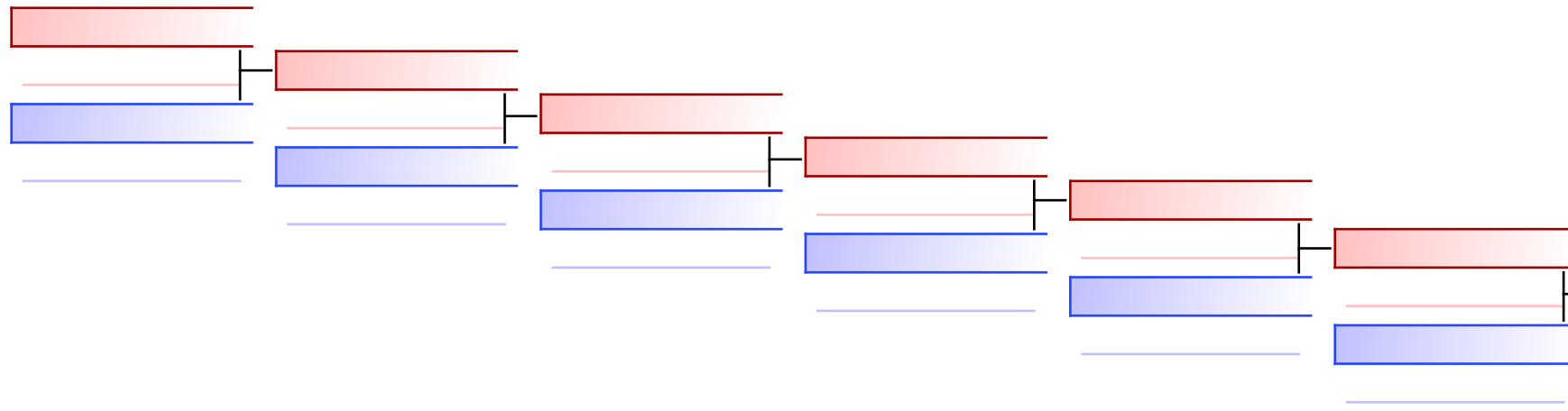

 Sportverein Karate-do Marchtrenk (Karate-do Marchtrenk)
029 Heian God. 2010
 Shin Tai Karate Vöcklabruck 2 (Shin Tai Karate Vöcklabruck)
 Shin Tai Karate Vöcklabruck 2 (Shin Tai Karate Vöcklabruck)
026 Heian Nid. 2030

TROSTRUNDE: (1)

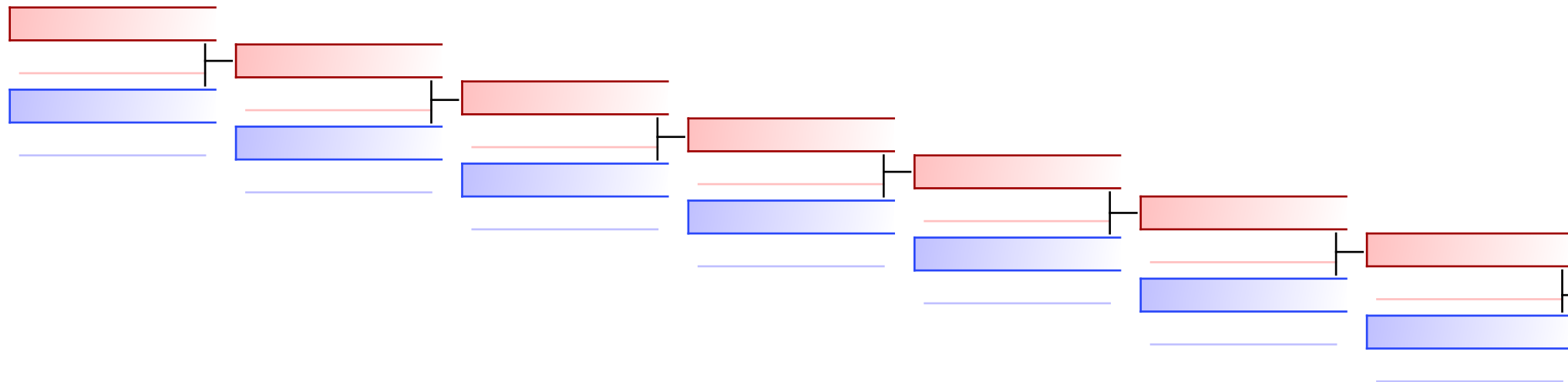





 Sportverein Karate-do Marchtrenk

Referees:							
-----------	--	--	--	--	--	--	--







Offizielle Ergebnisliste

Kata Team female U16			
1	UNION KARATECLUB GRIESKIRCHEN - HINTERBERGER MIA - HUBER SOPHIA-MARIE - HÖRMANDINGER ELINA		AUT - AUSTRIA
2	ALTMÜNSTER 2 - HÜTTNER VIKTORIA - JANECEK ELINA - MITTENDORFER CHRISTINA		AUT - AUSTRIA
3	SPORTVEREIN KARATE-DO MARCHTRENK - TRUMIC AMINA - JELICA GABRIELA - COVIC SAURA		AUT - AUSTRIA
3	SHIN TAI KARATE VÖCKLABRUCK 2 - WEINBERGER PIA - JUNG LENA - GÜNTHER MIA		AUT - AUSTRIA
5	SPORTVEREIN KARATE-DO MARCHTRENK - TRUMIC SUMEJA - BEGOVIC NADIJA - MEMIC HANA		AUT - AUSTRIA

KATA TEAM MALE U12



Offizielle Ergebnisliste

Kata Team male U12			
1	ASKÖ SEIBUKAN LINZ - CHEN CHENKAI - HEINISCH LEON - MARKOVIC ANDREJ		AUT - AUSTRIA
2	UNION KARATECLUB GRIESKIRCHEN - FLATTINGER BEN - MÜHLBAUER ALEXANDER - SCHINDLER LAURENZ		AUT - AUSTRIA
3	SHIN TAI KARATE VÖCKLABRUCK - WIMMER JONAS - STROBLMAYR SAMUEL - HEMETSBERGER MAXIMILIAN		AUT - AUSTRIA
4	ATSV LENZING SEKTION KARATE 2 - ODOBASIC HARIS - ROITHER MICHAEL - SCHMID MORITZ		AUT - AUSTRIA





OÖ Landesmeisterschaft und OÖ
Meisterschaft 2024 - 2024-04-13

Kata Team male U12

R1 G1/1 (4) Tatami 3 11:25(2024-04-13)

Teilnehmer	Kata	1	2	3	4	5	6	7	TOTAL	ExtraGesamRang
1 UNION KARATECLUB GRIESKIRCHEN (FLATTINGER, MÜHLBAUER, SCHINDLER) (UKC GRIESKIRCHEN)	TAIKYOKU SHODAN	(7.0)	(6.0)	7.0	7.0	7.0			21.0	21.0 2
2 ATSV LENZING SEKTION KARATE 2 (ODOBASIC, ROITHER, SCHMID) (LENZING)	TAIKYOKU SHODAN	6.0	(5.0)	6.0	(8.0)	6.0			18.0	18.0 4
3 SHIN TAI KARATE VÖCKLABRUCK (HEMETSBERGER, STROBLMAYR, WIMMER) (SHIN TAI KARATE VÖCKLABRUCK)	025 HEIAN SHODAN	7.0	8.0	(5.0)	6.0	(9.0)			21.0	21.0 3
4 ASKÖ SEIBUKAN LINZ (CHEN, HEINISCH, MARKOVIC) (SBK LINZ)	026 HEIAN NIDAN	(8.0)	(9.0)	8.0	9.0	8.0			25.0	25.0 1

Results



1 ASKÖ SEIBUKAN LINZ - CHEN CHENKAI - HEINISCH LEON - MARKOVIC ANDREJ		AUSTRIA
2 UNION KARATECLUB GRIESKIRCHEN - FLATTINGER BEN - MÜHLBAUER ALEXANDER - SCHINDLER LAURENZ		AUSTRIA
3 SHIN TAI KARATE VÖCKLABRUCK - WIMMER JONAS - STROBLMAYR SAMUEL - HEMETSBERGER MAXIMILIAN		AUSTRIA
4 ATSV LENZING SEKTION KARATE 2 - ODOBASIC HARIS - ROITHER MICHAEL - SCHMID MORITZ		AUSTRIA

KATA TEAM MALE U21



OÖ Landesmeisterschaft und OÖ
Meisterschaft 2024 - 2024-04-13

Offizielle Ergebnisliste

Kata Team male U21			
1	ATSV LENZING SEKTION KARATE 3 - EGGL JOHANNES - HOSSEINI SARO - NAGEL RAPHAEL		AUT - AUSTRIA
2	ASKÖ SEIBUKAN LINZ - ACKERBAUER ANDREAS - GALATEANU DAVID - MAYR WERNER		AUT - AUSTRIA
3	ASKÖ SEIBUKAN LINZ - GADERER JULIAN - SEDEQY JOSEF - TRAN TOMMY		AUT - AUSTRIA



OÖ Landesmeisterschaft und OÖ
Meisterschaft 2024 - 2024-04-13

Kata Team male U21

R1 G1/1 (3) Tatami 2 12:05(2024-04-13)

Teilnehmer	Kata	1	2	3	4	5	6	7	TOTAL	ExtraGesamRang
1 ATSV LENZING SEKTION KARATE 3 (EGGL, HOSSEINI, NAGEL) (LENZING)		(7.0)	(9.0)	9.0	9.0	9.0			27.0	27.0 1
2 ASKÖ SEIBUKAN LINZ (GADERER, SEDEQY, TRAN) (SBK LINZ)		(6.0)	(8.0)	7.0	7.0	7.0			21.0	21.0 3
3 ASKÖ SEIBUKAN LINZ (ACKERBAUER, GALATEANU, MAYR) (SBK LINZ)		(8.0)	(7.0)	8.0	8.0	8.0			24.0	24.0 2

Results

1 ATSV LENZING SEKTION KARATE 3 - EGGL JOHANNES - HOSSEINI SARO - NAGEL RAPHAEL		AUSTRIA
2 ASKÖ SEIBUKAN LINZ - ACKERBAUER ANDREAS - GALATEANU DAVID - MAYR WERNER		AUSTRIA
3 ASKÖ SEIBUKAN LINZ - GADERER JULIAN - SEDEQY JOSEF - TRAN TOMMY		AUSTRIA

KUMITE INDIVIDUAL FEMALE
SENIORS 35+ OPEN

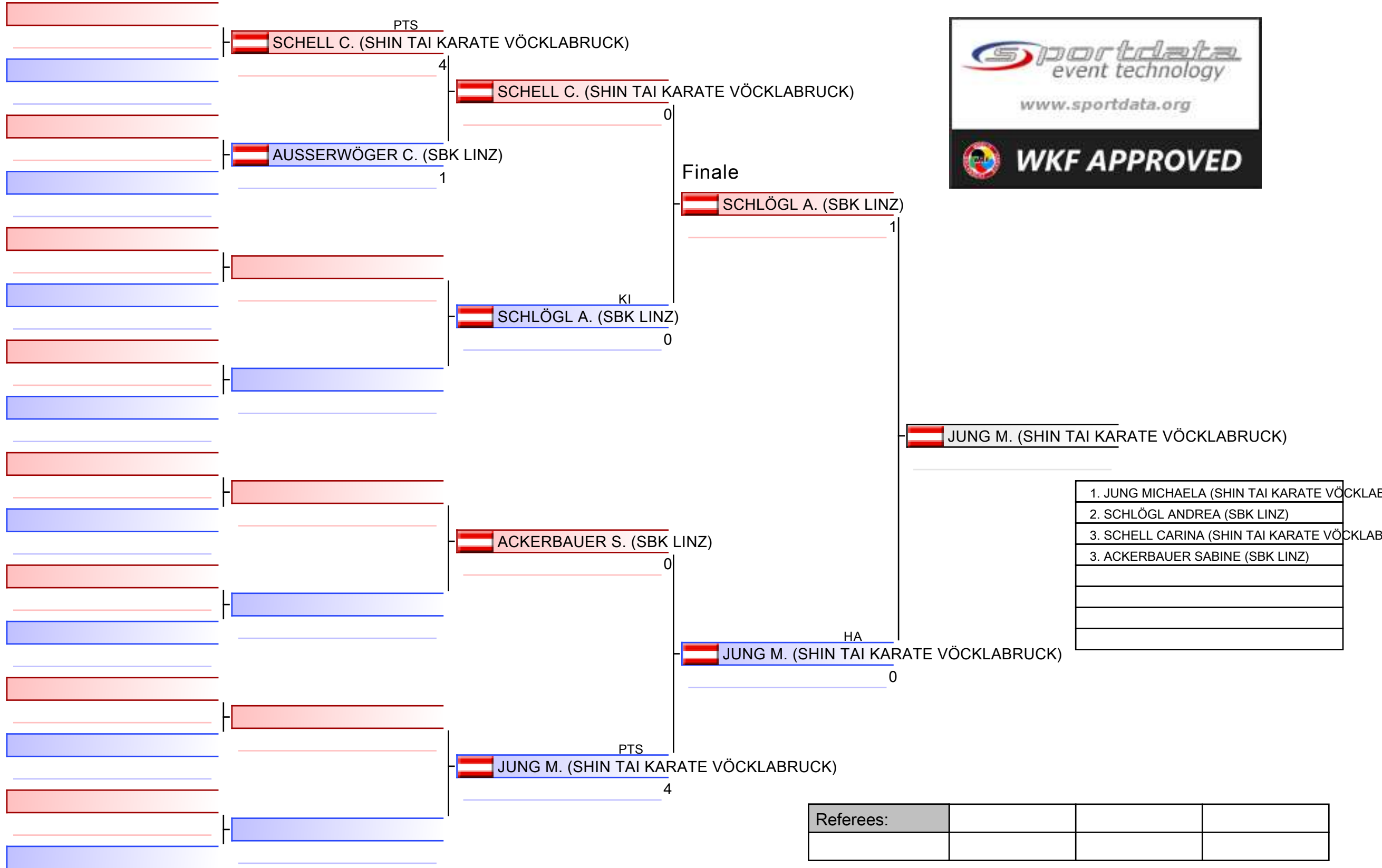

Kumite Individual Female Seniors 35+ Open

OÖ Landesmeisterschaft und OÖ Meisterschaft 2024

2024-04-13

Tatami
3 13:35

Pool
1

(c)sportdata GmbH & Co KG 2000-2024 (2024-04-14 21:44) v 10.2.0 build 1 (2024-04-06 19:39 CET) Lizenz: SDIL_TV-Graphics (expire 2024-12-31)

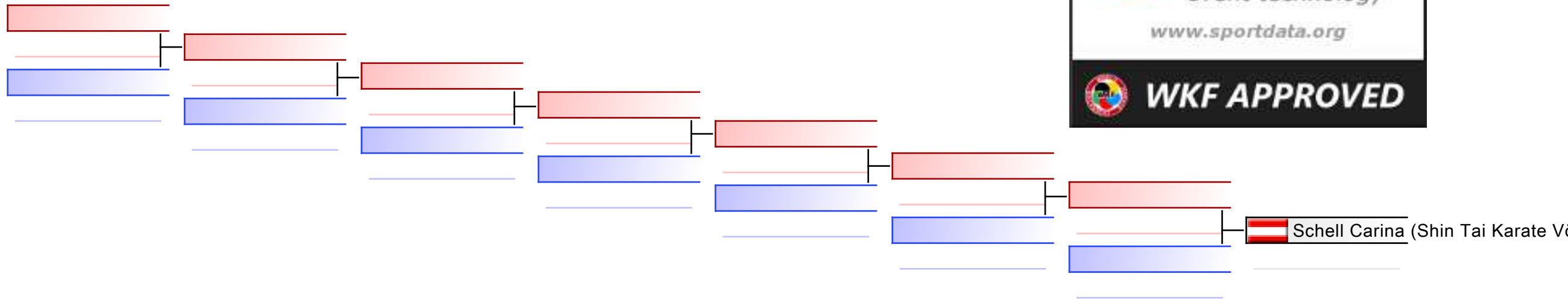

TROSTRUNDE: (1)

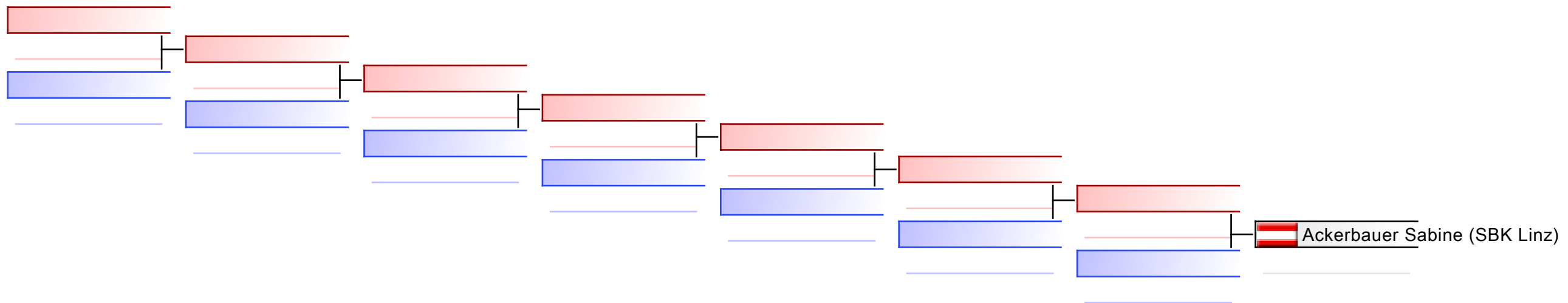





Referees:							
-----------	--	--	--	--	--	--	--



OÖ Landesmeisterschaft und OÖ
Meisterschaft 2024 - 2024-04-13

Offizielle Ergebnisliste

Kumite Individual Female Seniors 35+ Open			
1	JUNG MICHAELA		AUT - AUSTRIA
2	SCHLÖGL ANDREA		AUT - AUSTRIA
3	SHELL CARINA		AUT - AUSTRIA
3	ACKERBAUER SABINE		AUT - AUSTRIA

KUMITE INDIVIDUAL MALE SENIORS
35+ OPEN

Kumite Individual Male Seniors 35+ Open

OÖ Landesmeisterschaft und OÖ Meisterschaft 2024

2024-04-13

Tatami
3 14:05

Pool
1

(c)sportdata GmbH & Co KG 2000-2024 (2024-04-14 21:44) v 10.2.0 build 1 (2024-04-06 19:39 CET) Lizenz: SDIL_TV-Graphics (expire 2024-12-31)

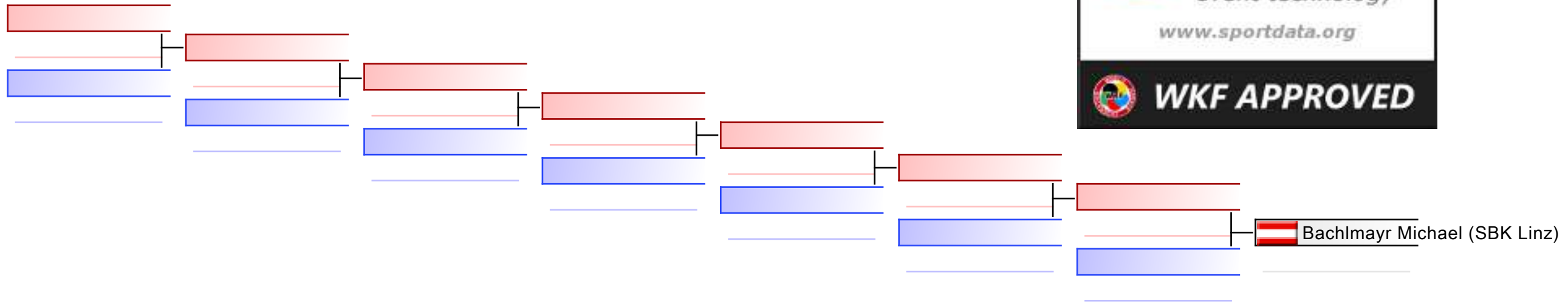

TROSTRUNDE: (1)

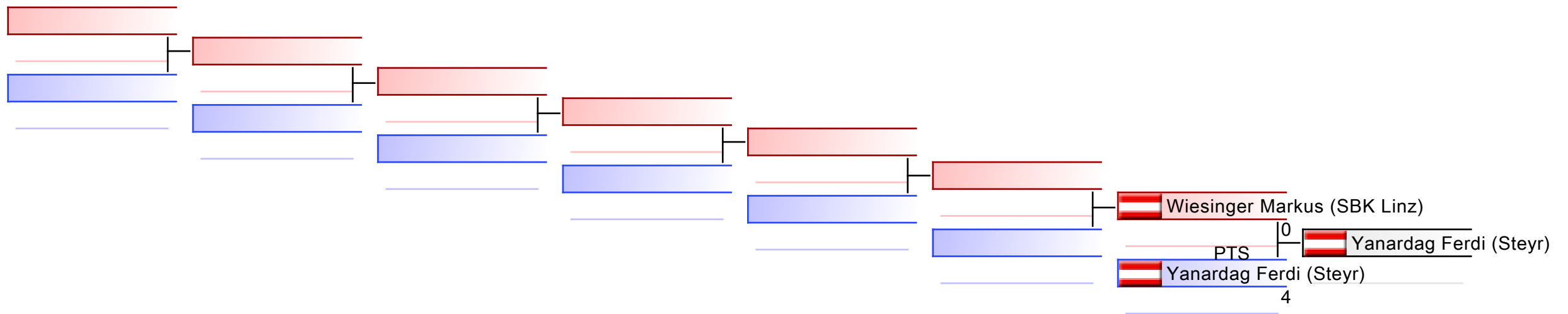





Referees:							
-----------	--	--	--	--	--	--	--



OÖ Landesmeisterschaft und OÖ
Meisterschaft 2024 - 2024-04-13

Offizielle Ergebnisliste

Kumite Individual Male Seniors 35+ Open			
1	SCHELL THOMAS		AUT - AUSTRIA
2	REINSPRECHT STEPHAN		AUT - AUSTRIA
3	BACHLMAYR MICHAEL		AUT - AUSTRIA
3	YANARDAG FERDI		AUT - AUSTRIA
5	WIESINGER MARKUS		AUT - AUSTRIA

KUMITE INDIVIDUAL FEMALE
SENIORS +68









Kumite Individual female Seniors +68 - Round Robin (jeder gegen jeden)

OÖ Landesmeisterschaft und OÖ Meisterschaft 2024, Europaplatz 5, 4663 Laakirchen, AUT

2024-04-13

Tatami
2 16:55

Pool
1/1

1	 STICHT P. (SBK LINZ)	5	 STICHT P. (SBK LINZ)
2	 BERISHA N. (SBK LINZ)	4	
	PTS		
3	 STICHT P. (SBK LINZ)	8	 STICHT P. (SBK LINZ)
4	 BLÜMELHUBER B. (STEYR)	0	
	PTS		
5	 BERISHA N. (SBK LINZ)	8	 BERISHA N. (SBK LINZ)
6	 BLÜMELHUBER B. (STEYR)	0	
	PTS		





1. STICHT PATRICIA (SBK LINZ)
2. BERISHA NATALIE (SBK LINZ)
3. BLÜMELHUBER BIANCA (STEYR)

Referees:			



OÖ Landesmeisterschaft und OÖ
Meisterschaft 2024 - 2024-04-13

Offizielle Ergebnisliste

Kumite Individual female Seniors +68			
1	STICHT PATRICIA		AUT - AUSTRIA
2	BERISHA NATALIE		AUT - AUSTRIA
3	BLÜMELHUBER BIANCA		AUT - AUSTRIA

KUMITE INDIVIDUAL FEMALE
SENIORS -68









Kumite Individual female Seniors -68 - Round Robin (jeder gegen jeden)

OÖ Landesmeisterschaft und OÖ Meisterschaft 2024, Europaplatz 5, 4663 Laakirchen, AUT

2024-04-13

Tatami
2 16:40

Pool
1/1

1	 JONAS S. (SHIN TAI KARATE VÖCKLABRUCK)	
	PTS	1  POINTNER L. (SBK LINZ)
2	 POINTNER L. (SBK LINZ)	10
3	 JONAS S. (SHIN TAI KARATE VÖCKLABRUCK)	
	PTS	0  FUCHS A. (SBK LINZ)
4	 FUCHS A. (SBK LINZ)	8
	PTS	
5	 POINTNER L. (SBK LINZ)	
	PTS	10  POINTNER L. (SBK LINZ)
6	 FUCHS A. (SBK LINZ)	7





1. POINTNER LISA (SBK LINZ)
2. FUCHS ANNA (SBK LINZ)
3. JONAS SARAH (SHIN TAI KARATE VÖCKLABRUCK)

Referees:			



OÖ Landesmeisterschaft und OÖ
Meisterschaft 2024 - 2024-04-13

Offizielle Ergebnisliste

Kumite Individual female Seniors -68			
1	POINTNER LISA		AUT - AUSTRIA
2	FUCHS ANNA		AUT - AUSTRIA
3	JONAS SARAH		AUT - AUSTRIA

KUMITE INDIVIDUAL FEMALE U10

Kumite Individual female U10

OÖ Landesmeisterschaft und OÖ Meisterschaft 2024, Europaplatz 5, 4663 Laakirchen, AUT

2024-04-13

Tatami

3 12:30

Pool

1/1

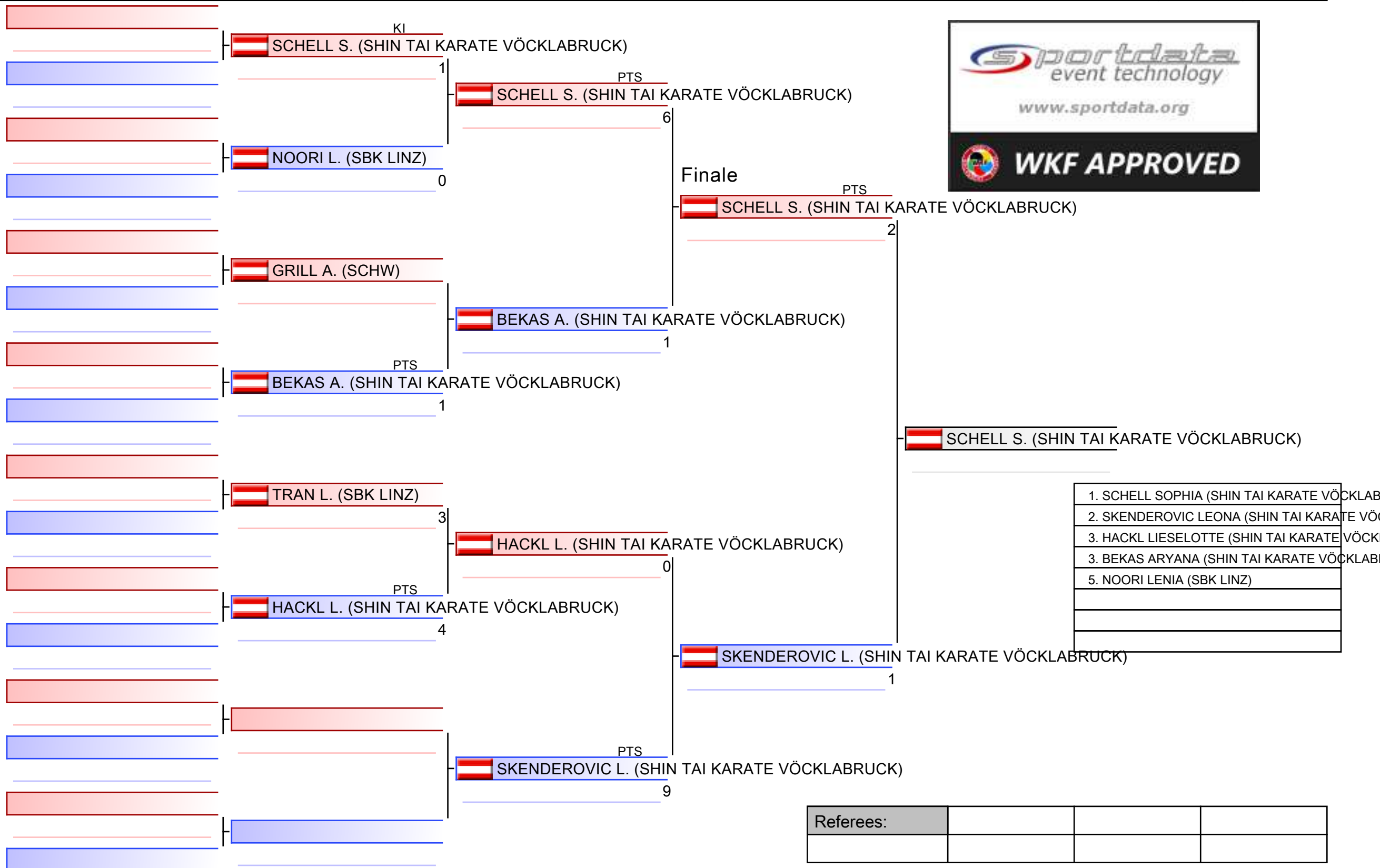

Referees:			

Kumite Individual female U10

OÖ Landesmeisterschaft und OÖ Meisterschaft 2024

2024-04-13

Tatami
3 12:30

Pool
1

(c)sportdata GmbH & Co KG 2000-2024 (2024-04-14 21:44) v 10.2.0 build 1 (2024-04-06 19:39 CET) Lizenz: SDIL_TV-GRAPHICS (expire 2024-12-31)

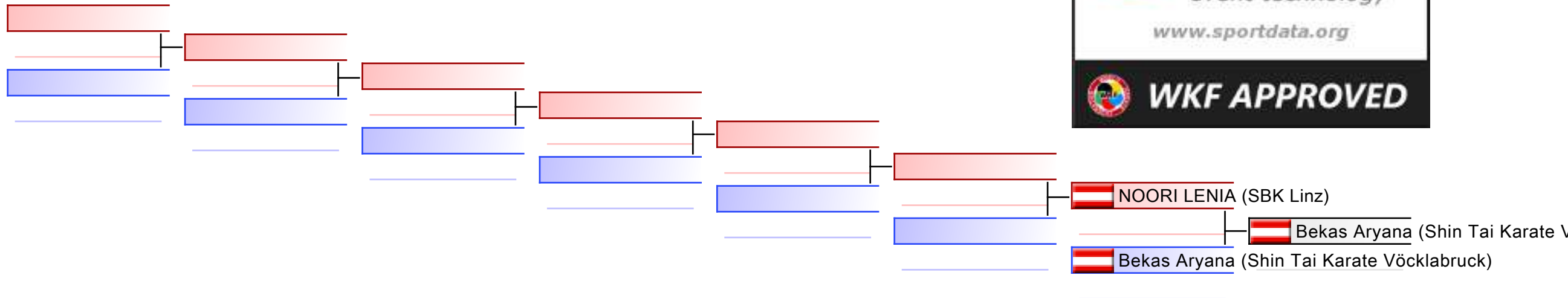

TROSTRUNDE: (1)

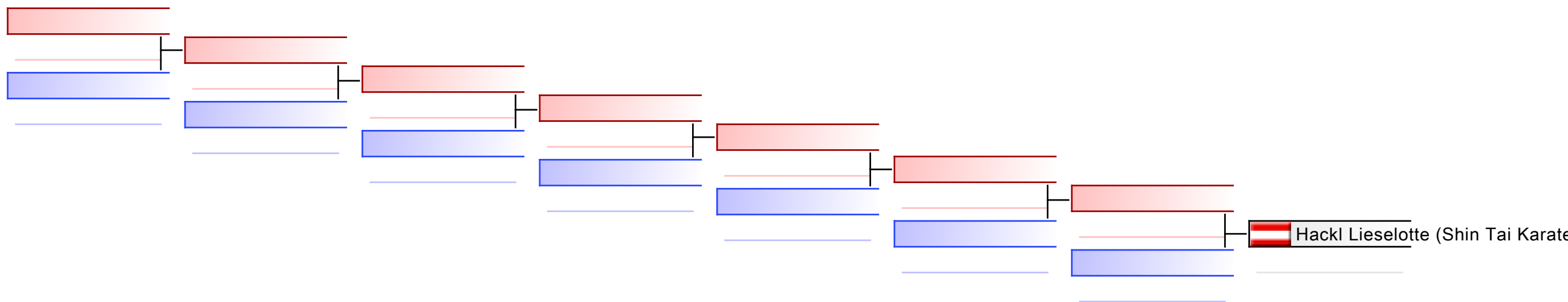





Referees:							
-----------	--	--	--	--	--	--	--



OÖ Landesmeisterschaft und OÖ
Meisterschaft 2024 - 2024-04-13

Offizielle Ergebnisliste

Kumite Individual female U10			
1	SCHELL SOPHIA		AUT - AUSTRIA
2	SKENDEROVIC LEONA		AUT - AUSTRIA
3	HACKL LIESELOTTE		AUT - AUSTRIA
3	BEKAS ARYANA		AUT - AUSTRIA
5	NOORI LENIA		AUT - AUSTRIA

KUMITE INDIVIDUAL FEMALE U12

Kumite Individual female U12

OÖ Landesmeisterschaft und OÖ Meisterschaft 2024, Europaplatz 5, 4663 Laakirchen, AUT

2024-04-13

Tatami
3 12:55

Pool
1/1

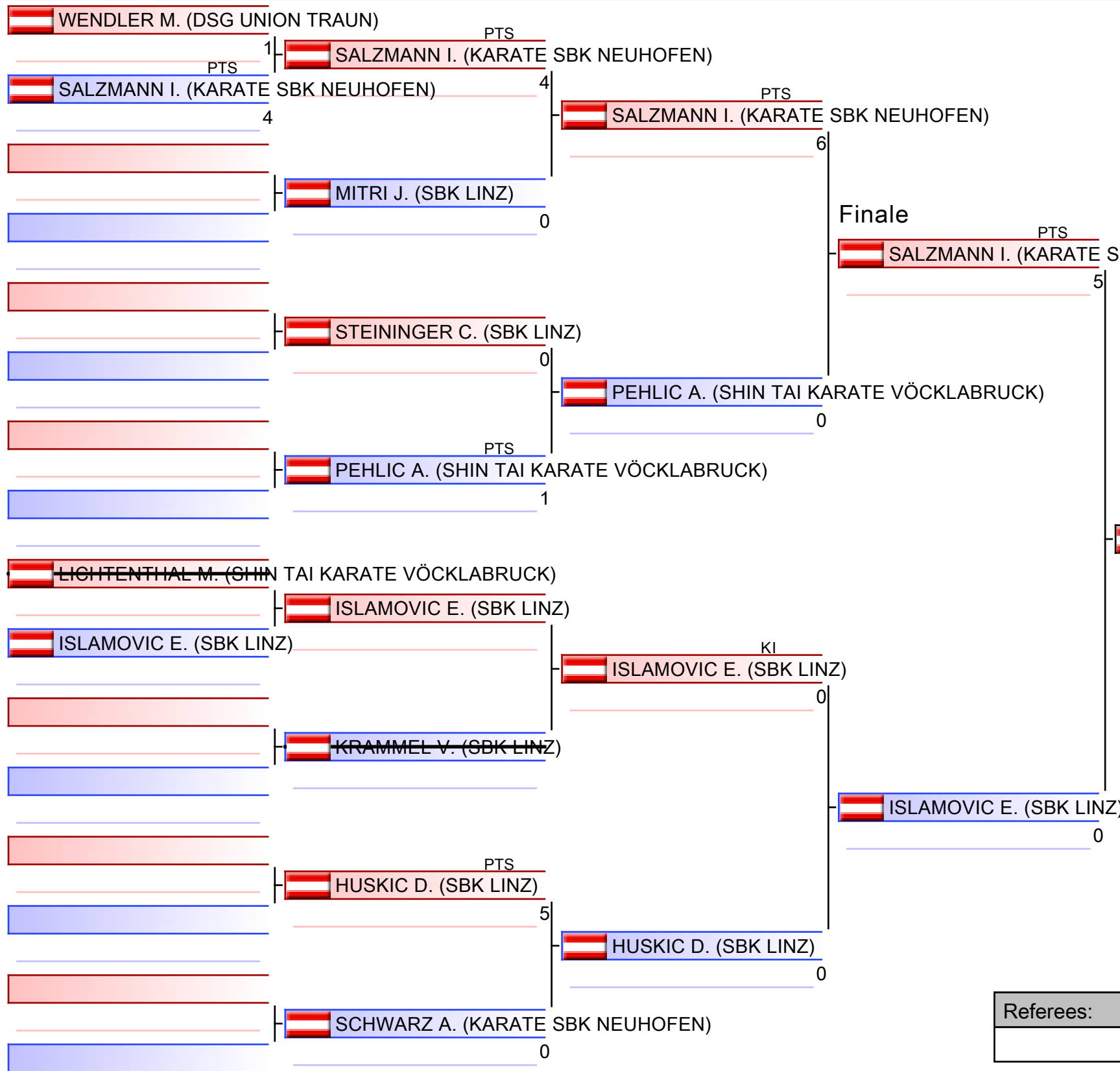

1. SALZMANN IDA (KARATE SBK NEUHOFEN)
2. ISLAMOVIC EMIRA (SBK LINZ)
3. HUSKIC DIANA (SBK LINZ)
3. WENDLER MIA DESIREÉ (DSG UNION TRAUN)
5. PEHLIC ALISA (SHIN TAI KARATE VÖCKLABRUCK)
7. MITRI JENNIFER (SBK LINZ)

Referees:			

Kumite Individual female U12

OÖ Landesmeisterschaft und OÖ Meisterschaft 2024

2024-04-13

Tatami
3 12:55

Pool
1

(c)sportdata GmbH & Co KG 2000-2024 (2024-04-14 21:44) v 10.2.0 build 1 (2024-04-06 19:39 CET) Lizenz: SDIL_TV-Graphics (expire 2024-12-31)

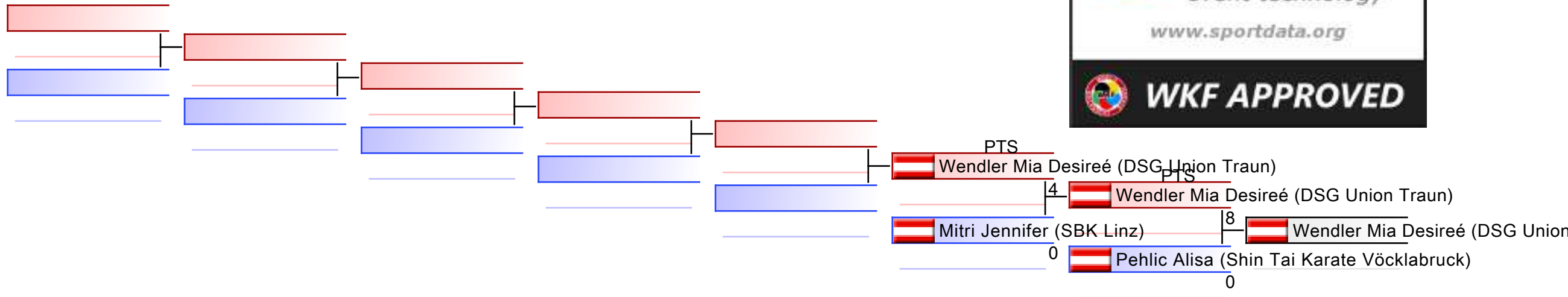

TROSTRUNDE: (1)

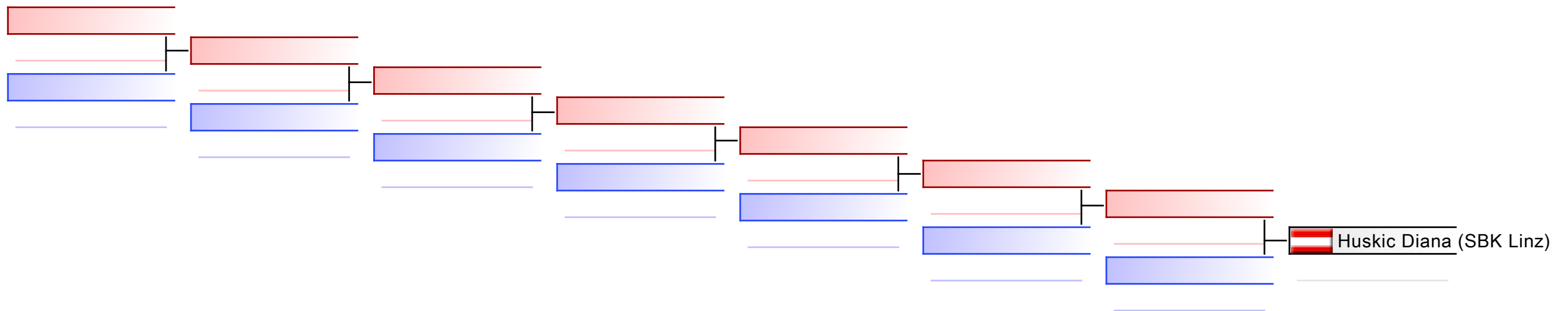







Referees:							
-----------	--	--	--	--	--	--	--



OÖ Landesmeisterschaft und OÖ
Meisterschaft 2024 - 2024-04-13

Offizielle Ergebnisliste

Kumite Individual female U12			
1	SALZMANN IDA		AUT - AUSTRIA
2	ISLAMOVIC EMIRA		AUT - AUSTRIA
3	HUSKIC DIANA		AUT - AUSTRIA
3	WENDLER MIA DESIREÉ		AUT - AUSTRIA
5	PEHLIC ALISA		AUT - AUSTRIA
7	MITRI JENNIFER		AUT - AUSTRIA

KUMITE INDIVIDUAL FEMALE U14

Kumite Individual female U14 - Round Robin (jeder gegen jeden)

OÖ Landesmeisterschaft und OÖ Meisterschaft 2024, Europaplatz 5, 4663 Laakirchen, AUT



















2024-04-13

Tatami

2 13:00

Pool

1/1

1	 HUSIDIC D. (KARATE-DO MARCHTRENK)	PTS	2	 GÜNTHER M. (SHIN TAI KARATE VÖCKLABRUCK)
2	 GÜNTHER M. (SHIN TAI KARATE VÖCKLABRUCK)	PTS	3	
3	 COVIC S. (KARATE-DO MARCHTRENK)	PTS	3	 COVIC S. (KARATE-DO MARCHTRENK)
4	 JUNG L. (SHIN TAI KARATE VÖCKLABRUCK)	PTS	0	
5	 HUSIDIC D. (KARATE-DO MARCHTRENK)	PTS	0	 COVIC S. (KARATE-DO MARCHTRENK)
6	 COVIC S. (KARATE-DO MARCHTRENK)	PTS	3	
7	 JUNG L. (SHIN TAI KARATE VÖCKLABRUCK)	SH	6	 GÜNTHER M. (SHIN TAI KARATE VÖCKLABRUCK)
8	 GÜNTHER M. (SHIN TAI KARATE VÖCKLABRUCK)	PTS	6	
9	 HUSIDIC D. (KARATE-DO MARCHTRENK)	PTS	2	 JUNG L. (SHIN TAI KARATE VÖCKLABRUCK)
10	 JUNG L. (SHIN TAI KARATE VÖCKLABRUCK)	PTS	3	
11	 GÜNTHER M. (SHIN TAI KARATE VÖCKLABRUCK)	PTS	3	 GÜNTHER M. (SHIN TAI KARATE VÖCKLABRUCK)
12	 COVIC S. (KARATE-DO MARCHTRENK)	PTS	2	







1. GÜNTHER MIA (SHIN TAI KARATE VÖCKLABRUCK)
2. COVIC SAURA (KARATE-DO MARCHTRENK)
3. JUNG LENA (SHIN TAI KARATE VÖCKLABRUCK)
4. HUSIDIC DAJRA (KARATE-DO MARCHTRENK)

Referees:			



OÖ Landesmeisterschaft und OÖ
Meisterschaft 2024 - 2024-04-13

Offizielle Ergebnisliste

Kumite Individual female U14			
1	GÜNTHER MIA		AUT - AUSTRIA
2	COVIC SAURA		AUT - AUSTRIA
3	JUNG LENA		AUT - AUSTRIA
4	HUSIDIC DAJRA		AUT - AUSTRIA

KUMITE INDIVIDUAL FEMALE U16
+54

Kumite Individual female U16 +54 - Round Robin (jeder gegen jeden)

OÖ Landesmeisterschaft und OÖ Meisterschaft 2024, Europaplatz 5, 4663 Laakirchen, AUT













2024-04-13

Tatami

2 13:20

Pool

1/1

1	 HITSCH S. (SHIN TAI KARATE VÖCKLABRUCK)	0	 GÖBELHAIDER S. (STEYR)
	PTS		
2	 GÖBELHAIDER S. (STEYR)	8	
	PTS		
3	 WEINBERGER P. (SHIN TAI KARATE VÖCKLABRUCK)	4	 WEINBERGER P. (SHIN TAI KARATE VÖCKLABRUCK)
4	 WINKLER A. (SHIN TAI KARATE VÖCKLABRUCK)	1	
	PTS		
5	 HITSCH S. (SHIN TAI KARATE VÖCKLABRUCK)	0	 WEINBERGER P. (SHIN TAI KARATE VÖCKLABRUCK)
	PTS		
6	 WEINBERGER P. (SHIN TAI KARATE VÖCKLABRUCK)	8	
	PTS		
7	 WINKLER A. (SHIN TAI KARATE VÖCKLABRUCK)	0	 GÖBELHAIDER S. (STEYR)
	PTS		
8	 GÖBELHAIDER S. (STEYR)	8	
	PTS		
9	 HITSCH S. (SHIN TAI KARATE VÖCKLABRUCK)	0	 WINKLER A. (SHIN TAI KARATE VÖCKLABRUCK)
	PTS		
10	 WINKLER A. (SHIN TAI KARATE VÖCKLABRUCK)	1	
	PTS		
11	 GÖBELHAIDER S. (STEYR)	5	 GÖBELHAIDER S. (STEYR)
12	 WEINBERGER P. (SHIN TAI KARATE VÖCKLABRUCK)	1	
	PTS		







1. GÖBELHAIDER STEPHANIE (STEYR)
2. WEINBERGER PIA (SHIN TAI KARATE VÖCKLABRUCK)
3. WINKLER ALINA (SHIN TAI KARATE VÖCKLABRUCK)
4. HITSCH SOPHIE (SHIN TAI KARATE VÖCKLABRUCK)

Referees:			



OÖ Landesmeisterschaft und OÖ
Meisterschaft 2024 - 2024-04-13

Offizielle Ergebnisliste

Kumite Individual female U16 +54			
1	GÖBELHAIDER STEPHANIE		AUT - AUSTRIA
2	WEINBERGER PIA		AUT - AUSTRIA
3	WINKLER ALINA		AUT - AUSTRIA
4	HITSCH SOPHIE		AUT - AUSTRIA

KUMITE INDIVIDUAL FEMALE U16 -54

Kumite Individual female U16 -54 - Round Robin (jeder gegen jeden)

OÖ Landesmeisterschaft und OÖ Meisterschaft 2024, Europaplatz 5, 4663 Laakirchen, AUT

2024-04-13

Tatami
2 13:45

Pool
1/1

1	TURANOVIC L. (STEYR)	0	ABLINGER S. (KARATE SEEWALCHEN)
	PTS		
2	ABLINGER S. (KARATE SEEWALCHEN)	8	
	PTS		
3	SAKANOVIC A. (WELS)	8	SAKANOVIC A. (WELS)
	PTS		
4	DINSTL L. (KARATE SBK NEUHOFEN)	0	
	PTS		
5	TURANOVIC L. (STEYR)	0	SAKANOVIC A. (WELS)
	PTS		
6	SAKANOVIC A. (WELS)	8	
	PTS		
7	DINSTL L. (KARATE SBK NEUHOFEN)	5	ABLINGER S. (KARATE SEEWALCHEN)
	PTS		
8	ABLINGER S. (KARATE SEEWALCHEN)	5	
	PTS		
9	TURANOVIC L. (STEYR)	4	DINSTL L. (KARATE SBK NEUHOFEN)
	PTS		
10	DINSTL L. (KARATE SBK NEUHOFEN)	5	
	PTS		
11	ABLINGER S. (KARATE SEEWALCHEN)	0	SAKANOVIC A. (WELS)
	PTS		
12	SAKANOVIC A. (WELS)	8	
	PTS		







1. SAKANOVIC ADNA (WELS)
2. ABLINGER SARAH (KARATE SEEWALCHEN)
3. DINSTL LINDA (KARATE SBK NEUHOFEN)
4. TURANOVIC LEJLA (STEYR)

Referees:			



OÖ Landesmeisterschaft und OÖ
Meisterschaft 2024 - 2024-04-13

Offizielle Ergebnisliste

Kumite Individual female U16 -54			
1	SAKANOVIC ADNA		AUT - AUSTRIA
2	ABLINGER SARAH		AUT - AUSTRIA
3	DINSTL LINDA		AUT - AUSTRIA
4	TURANOVIC LEJLA		AUT - AUSTRIA

KUMITE INDIVIDUAL FEMALE U18 -53









Kumite Individual female U18 -53 - Round Robin (jeder gegen jeden)

OÖ Landesmeisterschaft und OÖ Meisterschaft 2024, Europaplatz 5, 4663 Laakirchen, AUT

2024-04-13

Tatami
2 14:10

Pool
1/1

1	 GALATEANU E. (SBK LINZ)	9	 GALATEANU E. (SBK LINZ)
2	 ISLAMOVIĆ A. (SBK LINZ)	0	
	PTS		
3	 GALATEANU E. (SBK LINZ)	8	 GALATEANU E. (SBK LINZ)
4	 GRUDKE L. (SHIN TAI KARATE VÖCKLABRUCK)	0	
	PTS		
5	 ISLAMOVIĆ A. (SBK LINZ)	4	 ISLAMOVIĆ A. (SBK LINZ)
6	 GRUDKE L. (SHIN TAI KARATE VÖCKLABRUCK)	0	
	PTS		





1. GALATEANU EVELYN (SBK LINZ)
2. ISLAMOVIĆ AJLA (SBK LINZ)
3. GRUDKE LINDA (SHIN TAI KARATE VÖCKLABRUCK)

Referees:			



OÖ Landesmeisterschaft und OÖ
Meisterschaft 2024 - 2024-04-13

Offizielle Ergebnisliste

Kumite Individual female U18 -53			
1	GALATEANU EVELYN		AUT - AUSTRIA
2	ISLAMOVIC AJLA		AUT - AUSTRIA
3	GRUDKE LINDA		AUT - AUSTRIA

KUMITE INDIVIDUAL MALE SENIORS

+84

Kumite Individual male Seniors +84

OÖ Landesmeisterschaft und OÖ Meisterschaft 2024

2024-04-13

Tatami
1 17:35

Pool
1

(c)sportdata GmbH & Co KG 2000-2024 (2024-04-14 21:44) v 10.2.0 build 1 (2024-04-06 19:39 CET) Lizenz: SDIL_TV-Graphics (expire 2024-12-31)

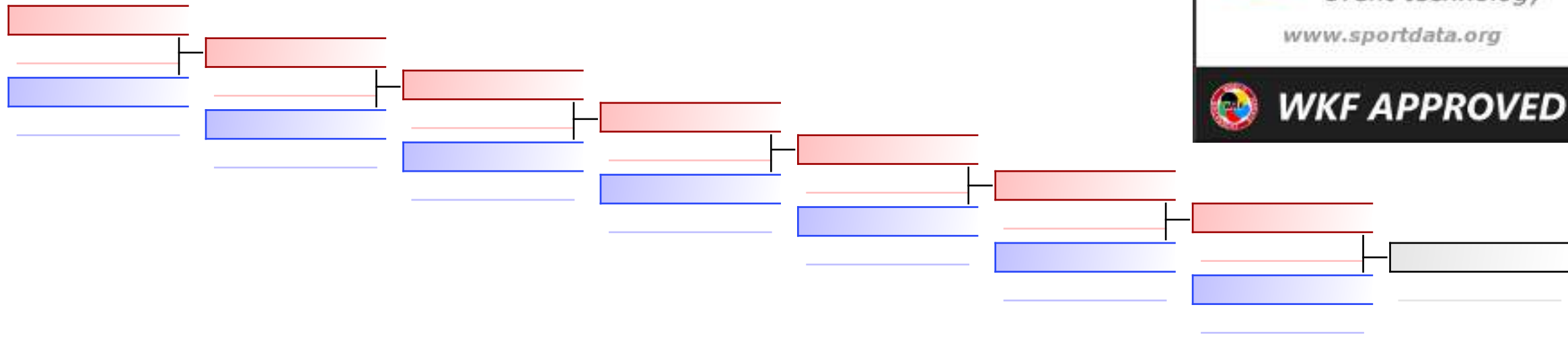

TROSTRUNDE: (1)

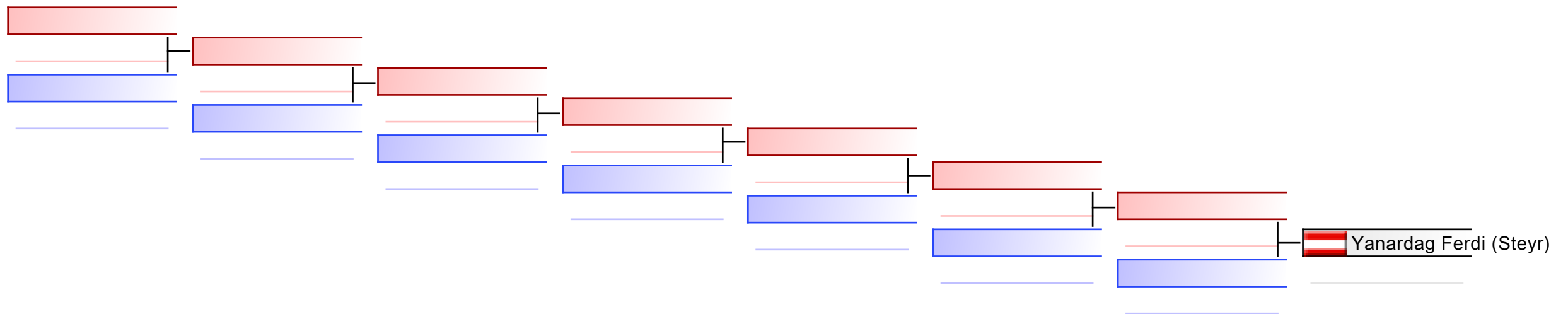



Referees:							
-----------	--	--	--	--	--	--	--



OÖ Landesmeisterschaft und OÖ
Meisterschaft 2024 - 2024-04-13

Offizielle Ergebnisliste

Kumite Individual male Seniors +84			
1	HERAC ELVEDIN		AUT - AUSTRIA
2	WEINBERGER STEFAN		AUT - AUSTRIA
3	YANARDAG FERDI		AUT - AUSTRIA

KUMITE INDIVIDUAL MALE SENIORS

-67









Kumite Individual male Seniors -67 - Round Robin (jeder gegen jeden)

OÖ Landesmeisterschaft und OÖ Meisterschaft 2024, Europaplatz 5, 4663 Laakirchen, AUT

2024-04-13

Tatami
1 16:00

Pool
1/1

1	 HUSKIC D. (SBK LINZ)	8	 HUSKIC D. (SBK LINZ)
2	 WIESINGER M. (SBK LINZ)	0	
3	 HUSKIC D. (SBK LINZ)	2	 HUSKIC D. (SBK LINZ)
4	 GROSSHAUPT E. (GM)	0	
5	 WIESINGER M. (SBK LINZ)	7	 WIESINGER M. (SBK LINZ)
6	 GROSSHAUPT E. (GM)	5	





1. HUSKIC DENIS (SBK LINZ)
2. WIESINGER MARKUS (SBK LINZ)
3. GROSSHAUPT ERIK (GM)

Referees:			



OÖ Landesmeisterschaft und OÖ
Meisterschaft 2024 - 2024-04-13

Offizielle Ergebnisliste

Kumite Individual male Seniors -67			
1	HUSKIC DENIS		AUT - AUSTRIA
2	WIESINGER MARKUS		AUT - AUSTRIA
3	GROSSHAUPT ERIK		AUT - AUSTRIA

KUMITE INDIVIDUAL MALE SENIORS

-75

























Kumite Individual male Seniors -75 - Round Robin (jeder gegen jeden)

OÖ Landesmeisterschaft und OÖ Meisterschaft 2024, Europaplatz 5, 4663 Laakirchen, AUT

2024-04-13

Tatami
1 16:15

Pool
1/1

- 1  NAGL G. (SHIN TAI KARATE VÖCKLABRUCK) vs  GRIGORASENCO N. (LZOÖ) | 0
- 2  GRIGORASENCO N. (LZOÖ) vs  8
- 3  ~~KLINGLMAYR G. (SHIN TAI KARATE VÖCKLABRUCK)~~ vs  BACHLMAYR M. (SBK LINZ)
- 4  BACHLMAYR M. (SBK LINZ) vs  8
- 5  NAGL G. (SHIN TAI KARATE VÖCKLABRUCK) vs  NAGL G. (SHIN TAI KARATE VÖCKLABRUCK)
- 6  ~~KLINGLMAYR G. (SHIN TAI KARATE VÖCKLABRUCK)~~ vs  8
- 7  BACHLMAYR M. (SBK LINZ) vs  GRIGORASENCO N. (LZOÖ) | 0
- 8  GRIGORASENCO N. (LZOÖ) vs  6
- 9  NAGL G. (SHIN TAI KARATE VÖCKLABRUCK) vs  NAGL G. (SHIN TAI KARATE VÖCKLABRUCK) | 8
- 10  BACHLMAYR M. (SBK LINZ) vs  0
- 11  GRIGORASENCO N. (LZOÖ) vs  GRIGORASENCO N. (LZOÖ)
- 12  ~~KLINGLMAYR G. (SHIN TAI KARATE VÖCKLABRUCK)~~ vs  8





1. GRIGORASENCO NICHITA (LZOÖ)
2. NAGL GREGOR (SHIN TAI KARATE VÖCKLABRUCK)
3. BACHLMAYR MICHAEL (SBK LINZ)

Referees:			



OÖ Landesmeisterschaft und OÖ
Meisterschaft 2024 - 2024-04-13

Offizielle Ergebnisliste

Kumite Individual male Seniors -75			
1	GRIGORASENCO NICHITA		AUT - AUSTRIA
2	NAGL GREGOR		AUT - AUSTRIA
3	BACHLMAYR MICHAEL		AUT - AUSTRIA

KUMITE INDIVIDUAL MALE SENIORS

-84

Kumite Individual male Seniors -84

OÖ Landesmeisterschaft und OÖ Meisterschaft 2024, Europaplatz 5, 4663 Laakirchen, AUT

2024-04-13

Tatami

3 16:35

Pool

1/1

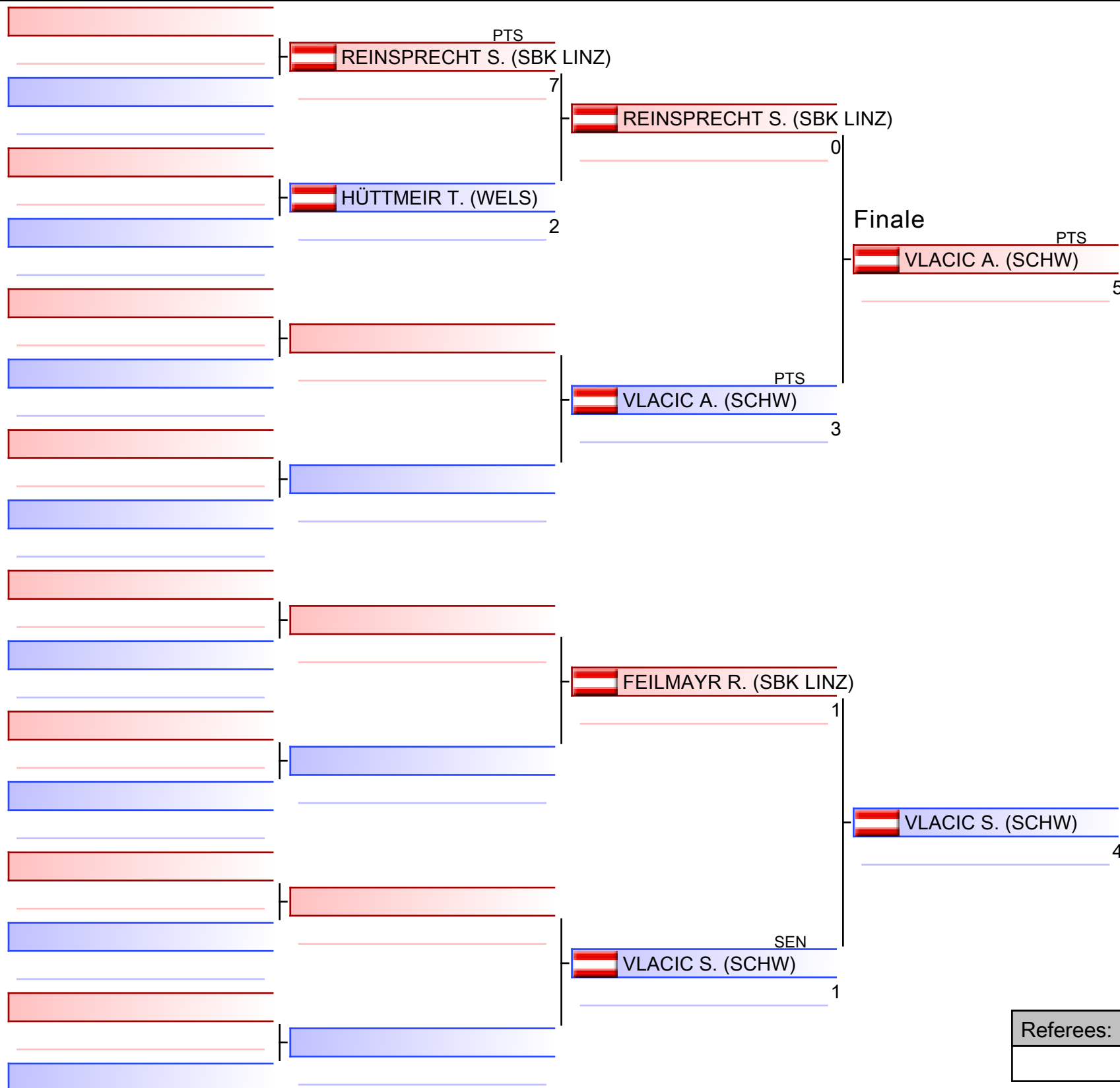

1. VLACIC ALEKSANDAR (SCHW)
2. VLACIC STEFAN (SCHW)
3. REINSPRECHT STEPHAN (SBK LINZ)
3. FEILMAYR RAPHAEL (SBK LINZ)

Referees:			

Kumite Individual male Seniors -84

OÖ Landesmeisterschaft und OÖ Meisterschaft 2024

2024-04-13

Tatami
3 16:35

Pool
1

(c)sportdata GmbH & Co KG 2000-2024 (2024-04-14 21:44) v 10.2.0 build 1 (2024-04-06 19:39 CET) Lizenz: SDIL_TV-GRAPHICS (expire 2024-12-31)

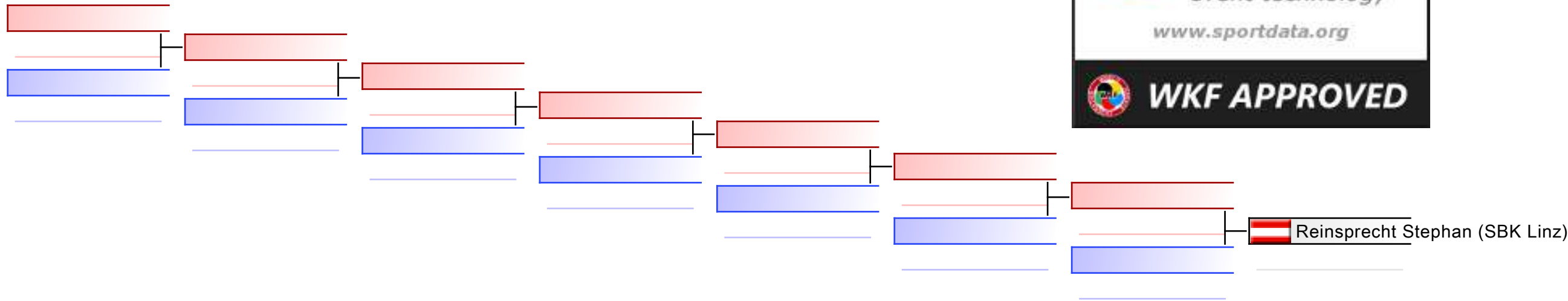

TROSTRUNDE: (1)

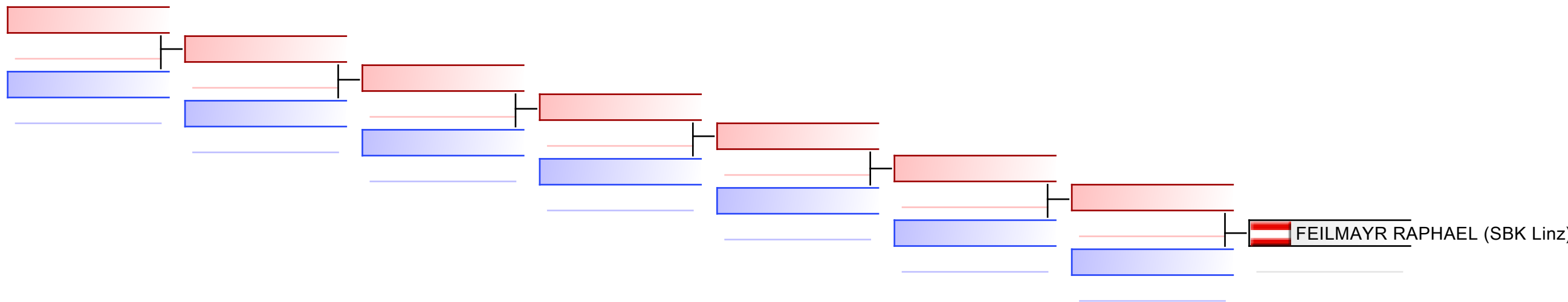





Referees:							
-----------	--	--	--	--	--	--	--



OÖ Landesmeisterschaft und OÖ
Meisterschaft 2024 - 2024-04-13

Offizielle Ergebnisliste

Kumite Individual male Seniors -84			
1	VLACIC ALEKSANDAR		AUT - AUSTRIA
2	VLACIC STEFAN		AUT - AUSTRIA
3	REINSPRECHT STEPHAN		AUT - AUSTRIA
3	FEILMAYR RAPHAEL		AUT - AUSTRIA

KUMITE INDIVIDUAL MALE U10

Kumite Individual male U10 - Round Robin (jeder gegen jeden)

OÖ Landesmeisterschaft und OÖ Meisterschaft 2024, Europaplatz 5, 4663 Laakirchen, AUT

2024-04-13

Tatami

1 13:00

Pool

1/1

- 1  HEMETSBERGER M. (SHIN TAI KARATE VÖCKLABRUCK)
0 |  MARKOVIC A. (SBK LINZ)
- 2  MARKOVIC A. (SBK LINZ)
4
- 3  ZEC D. (DSG UNION TRAUN)
0 |  REICHL F. (KARATE SBK NEUHOFEN)
- 4  REICHL F. (KARATE SBK NEUHOFEN)
8
- 5  HEMETSBERGER M. (SHIN TAI KARATE VÖCKLABRUCK)
1 |  ZEC D. (DSG UNION TRAUN)
- 6  ZEC D. (DSG UNION TRAUN)
3
- 7  REICHL F. (KARATE SBK NEUHOFEN)
4 |  REICHL F. (KARATE SBK NEUHOFEN)
- 8  MARKOVIC A. (SBK LINZ)
2
- 9  HEMETSBERGER M. (SHIN TAI KARATE VÖCKLABRUCK)
0 |  REICHL F. (KARATE SBK NEUHOFEN)
- 10  REICHL F. (KARATE SBK NEUHOFEN)
8
- 11  MARKOVIC A. (SBK LINZ)
6 |  MARKOVIC A. (SBK LINZ)
- 12  ZEC D. (DSG UNION TRAUN)
3







1. REICHL FINN (KARATE SBK NEUHOFEN)
2. MARKOVIC ANDREJ (SBK LINZ)
3. ZEC DANIS (DSG UNION TRAUN)
4. HEMETSBERGER MAXIMILIAN (SHIN TAI KARATE VÖCKLABRUCK)

Referees:			



OÖ Landesmeisterschaft und OÖ
Meisterschaft 2024 - 2024-04-13

Offizielle Ergebnisliste

Kumite Individual male U10			
1	REICHL FINN		AUT - AUSTRIA
2	MARKOVIC ANDREJ		AUT - AUSTRIA
3	ZEC DANIS		AUT - AUSTRIA
4	HEMETSBERGER MAXIMILIAN		AUT - AUSTRIA

KUMITE INDIVIDUAL MALE U12

Kumite Individual male U12

OÖ Landesmeisterschaft und OÖ Meisterschaft 2024, Europaplatz 5, 4663 Laakirchen, AUT

2024-04-13

Tatami

1 13:20

Pool

1/1

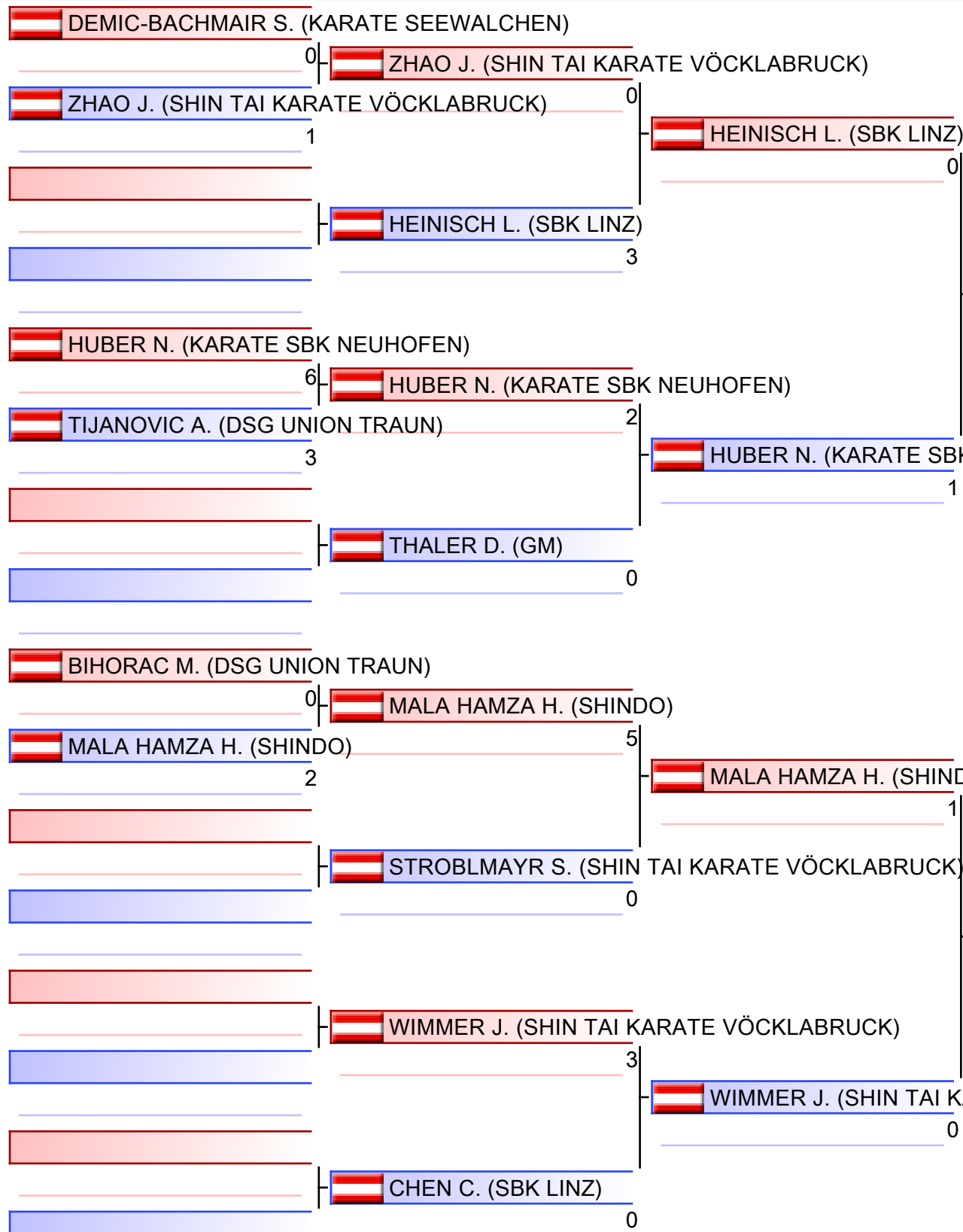

- | |
|--|
| 1. MALA HAMZA HEM (SHINDO) |
| 2. HUBER NICLAS (KARATE SBK NEUHOFEN) |
| 3. HEINISCH LEON (SBK LINZ) |
| 3. BIHORAC MUHAMED (DSG UNION TRAUN) |
| 5. TIJANOVIC ADIN (DSG UNION TRAUN) |
| 5. WIMMER JONAS (SHIN TAI KARATE VÖCKLABRUCK) |
| 7. THALER DOMINIK (GM) |
| 7. STROBLMAYR SAMUEL (SHIN TAI KARATE VÖCKLABRUCK) |

Referees:			

Kumite Individual male U12

OÖ Landesmeisterschaft und OÖ Meisterschaft 2024

2024-04-13

Tatami
1 13:20

Pool
1

(c)sportdata GmbH & Co KG 2000-2024 (2024-04-14 21:44) v 10.2.0 build 1 (2024-04-06 19:39 CET) Lizenz: SDIL_TV-GRAPHICS (expire 2024-12-31)

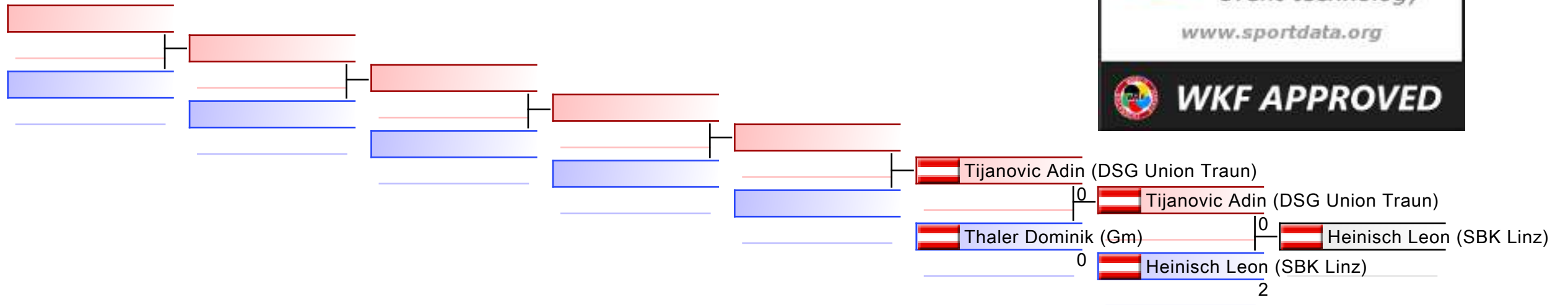

TROSTRUNDE: (1)

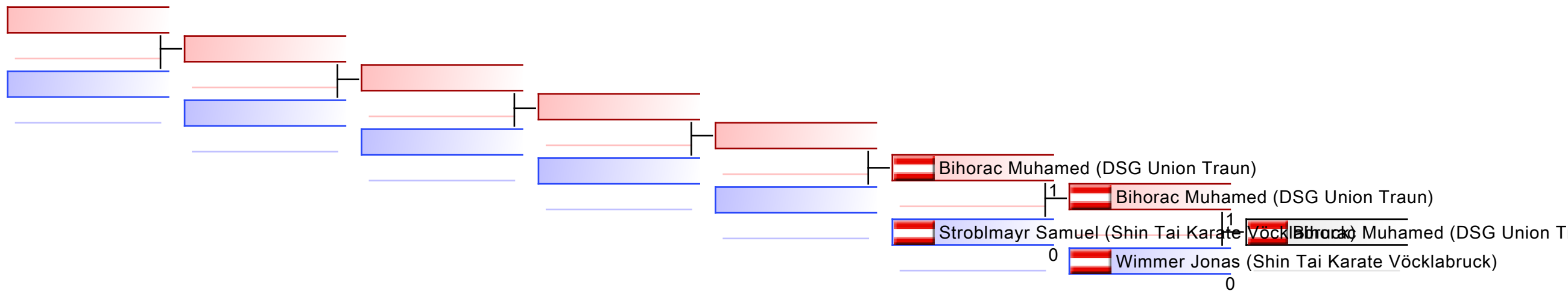









Referees:							
-----------	--	--	--	--	--	--	--



OÖ Landesmeisterschaft und OÖ
Meisterschaft 2024 - 2024-04-13

Offizielle Ergebnisliste

Kumite Individual male U12			
1	MALA HAMZA HEM		AUT - AUSTRIA
2	HUBER NICLAS		AUT - AUSTRIA
3	HEINISCH LEON		AUT - AUSTRIA
3	BIHORAC MUHAMED		AUT - AUSTRIA
5	TIJANOVIC ADIN		AUT - AUSTRIA
5	WIMMER JONAS		AUT - AUSTRIA
7	THALER DOMINIK		AUT - AUSTRIA
7	STROBLMAYR SAMUEL		AUT - AUSTRIA

KUMITE INDIVIDUAL MALE U14

Kumite Individual male U14

OÖ Landesmeisterschaft und OÖ Meisterschaft 2024, Europaplatz 5, 4663 Laakirchen, AUT

2024-04-13

Tatami
1 14:05

Pool
1/1

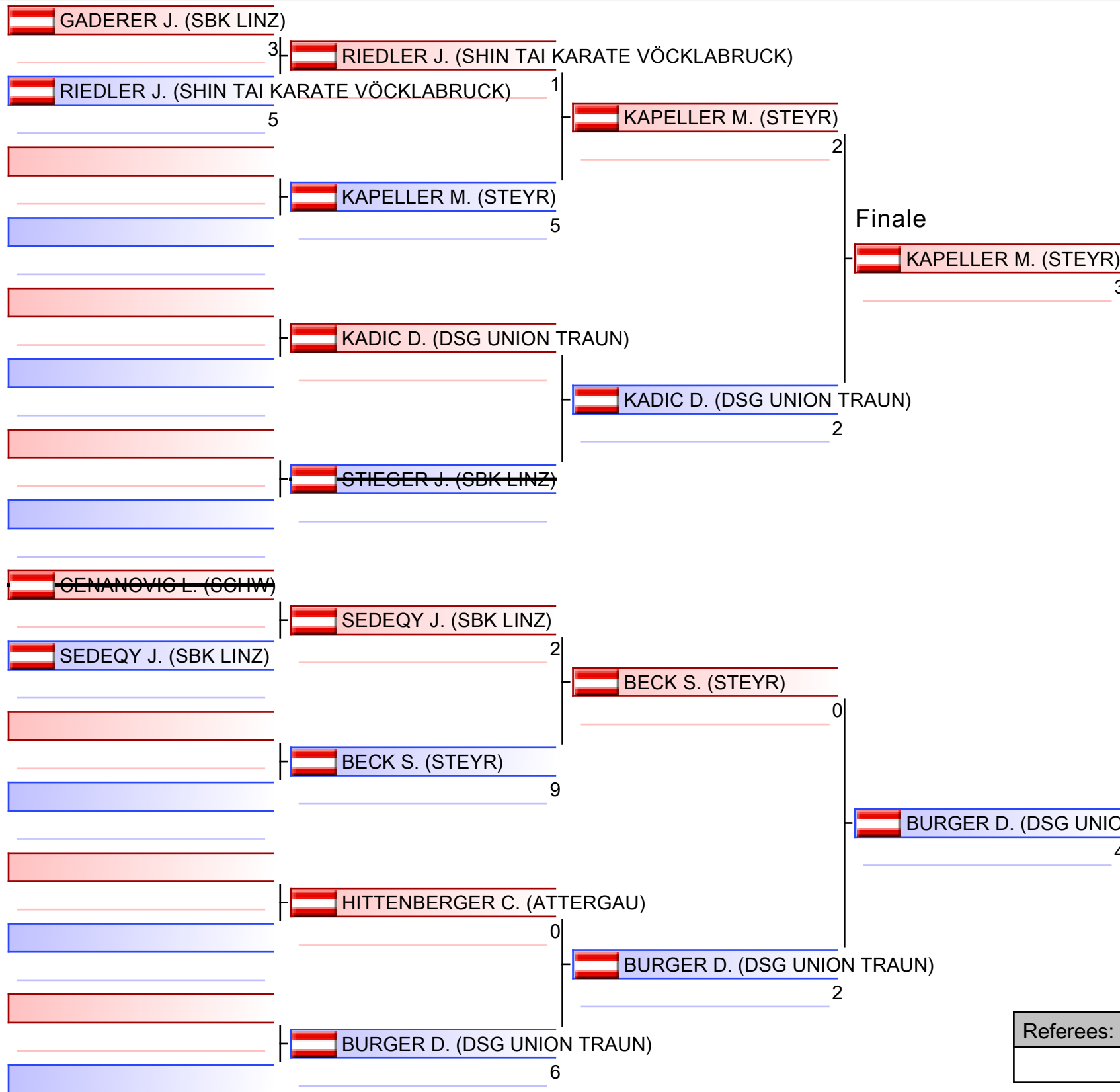

1. BURGER DIEGO (DSG UNION TRAUN)
2. KAPPELLER MORITZ (STEYR)
3. RIEDLER JONAS (SHIN TAI KARATE VÖCKLABRUCK)
3. BECK SEBASTIAN (STEYR)
5. KADIC DAVUD (DSG UNION TRAUN)
5. HITTENBERGER CHRISTOPHER MARTIN (ATTERGAU)

Referees:			

Kumite Individual male U14

OÖ Landesmeisterschaft und OÖ Meisterschaft 2024

2024-04-13

Tatami
1 14:05

Pool
1

(c)sportdata GmbH & Co KG 2000-2024 (2024-04-14 21:44) v 10.2.0 build 1 (2024-04-06 19:39 CET) Lizenz: SDIL_TV-Graphics (expire 2024-12-31)

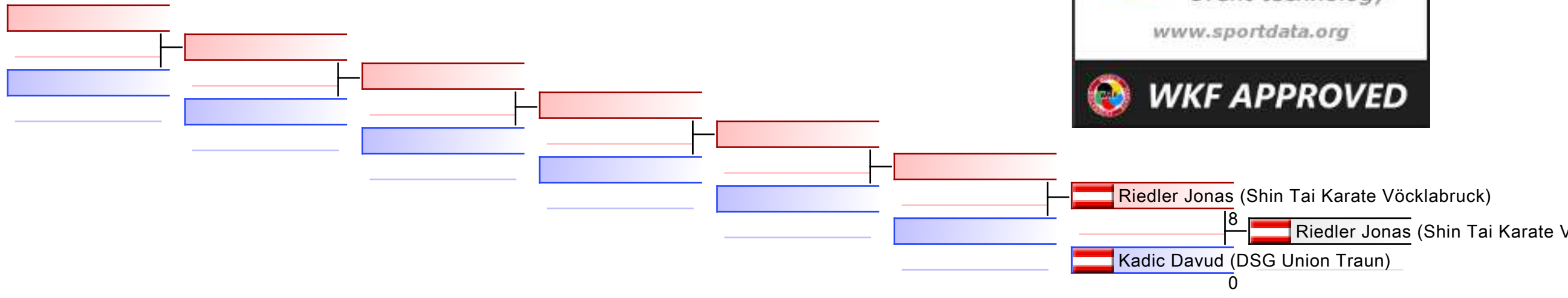

TROSTRUNDE: (1)

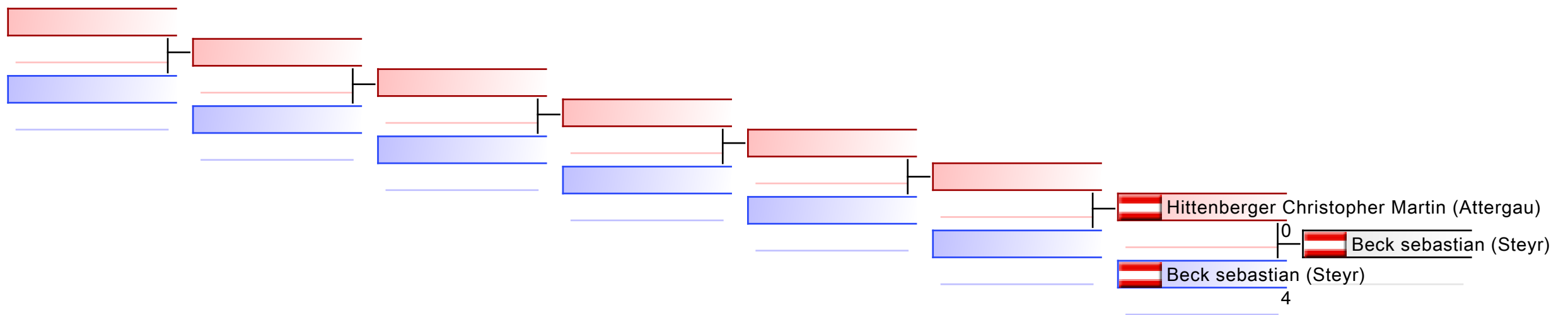







Referees:							
-----------	--	--	--	--	--	--	--



OÖ Landesmeisterschaft und OÖ
Meisterschaft 2024 - 2024-04-13

Offizielle Ergebnisliste

Kumite Individual male U14			
1	BURGER DIEGO		AUT - AUSTRIA
2	KAPELLER MORITZ		AUT - AUSTRIA
3	RIEDLER JONAS		AUT - AUSTRIA
3	BECK SEBASTIAN		AUT - AUSTRIA
5	KADIC DAVUD		AUT - AUSTRIA
5	HITTENBERGER CHRISTOPHER MARTIN		AUT - AUSTRIA

KUMITE INDIVIDUAL MALE U16 +70









Kumite Individual male U16 +70 - Round Robin (jeder gegen jeden)

OÖ Landesmeisterschaft und OÖ Meisterschaft 2024, Europaplatz 5, 4663 Laakirchen, AUT

2024-04-13

Tatami
2 14:25

Pool
1/1

1	 MAYR W. (SBK LINZ)	 MAYR W. (SBK LINZ)
2	 BEGANOVIC S. (SBK LINZ)	
	PTS	
3	 MAYR W. (SBK LINZ)	8  MAYR W. (SBK LINZ)
4	 HOSSEINI S. (LENZING)	0
5	 BEGANOVIC S. (SBK LINZ)	 HOSSEINI S. (LENZING)
6	 HOSSEINI S. (LENZING)	





1. MAYR WERNER (SBK LINZ)
2. HOSSEINI SARO (LENZING)

Referees:			



OÖ Landesmeisterschaft und OÖ
Meisterschaft 2024 - 2024-04-13

Offizielle Ergebnisliste

Kumite Individual male U16 +70			
1	MAYR WERNER		AUT - AUSTRIA
2	HOSSEINI SARO		AUT - AUSTRIA

KUMITE INDIVIDUAL MALE U16 -52

Kumite Individual male U16 -52 - Round Robin (jeder gegen jeden)

OÖ Landesmeisterschaft und OÖ Meisterschaft 2024, Europaplatz 5, 4663 Laakirchen, AUT

2024-04-13

Tatami

1 15:35

Pool

1/1

- 1  VOGLHUBER A. (KARATE SEEWALCHEN)
 - 0 |  HANKOWETZ J. (KARATE SBK NEUHOFEN)
- 2  HANKOWETZ J. (KARATE SBK NEUHOFEN)
 - 1
- 3  HOLZINGER A. (SHIN TAI KARATE VÖCKLABRUCK)
 - 0 |  ACKERBAUER A. (SBK LINZ)
- 4  ACKERBAUER A. (SBK LINZ)
 - 9
- 5  VOGLHUBER A. (KARATE SEEWALCHEN)
 - 1 |  VOGLHUBER A. (KARATE SEEWALCHEN)
- 6  HOLZINGER A. (SHIN TAI KARATE VÖCKLABRUCK)
 - 1
- 7  ACKERBAUER A. (SBK LINZ)
 - 3 |  ACKERBAUER A. (SBK LINZ)
- 8  HANKOWETZ J. (KARATE SBK NEUHOFEN)
 - 0
- 9  VOGLHUBER A. (KARATE SEEWALCHEN)
 - 0 |  ACKERBAUER A. (SBK LINZ)
- 10  ACKERBAUER A. (SBK LINZ)
 - 2
- 11  HANKOWETZ J. (KARATE SBK NEUHOFEN)
 - 2 |  HANKOWETZ J. (KARATE SBK NEUHOFEN)
- 12  HOLZINGER A. (SHIN TAI KARATE VÖCKLABRUCK)
 - 0







1. ACKERBAUER ANDREAS (SBK LINZ)	
2. HANKOWETZ JAKOB (KARATE SBK NEUHOFEN)	
3. VOGLHUBER ALEXANDER (KARATE SEEWALCHEN)	
4. HOLZINGER ALEXANDER (SHIN TAI KARATE VÖCKLABRUCK)	

Referees:			



OÖ Landesmeisterschaft und OÖ
Meisterschaft 2024 - 2024-04-13

Offizielle Ergebnisliste

Kumite Individual male U16 -52			
1	ACKERBAUER ANDREAS		AUT - AUSTRIA
2	HANKOWETZ JAKOB		AUT - AUSTRIA
3	VOGLHUBER ALEXANDER		AUT - AUSTRIA
4	HOLZINGER ALEXANDER		AUT - AUSTRIA

KUMITE INDIVIDUAL MALE U16 -57









Kumite Individual male U16 -57 - Round Robin (jeder gegen jeden)

OÖ Landesmeisterschaft und OÖ Meisterschaft 2024, Europaplatz 5, 4663 Laakirchen, AUT

2024-04-13

Tatami
2 14:40

Pool
1/1

1	 GALATEANU D. (SBK LINZ)		 GALATEANU D. (SBK LINZ)
2	 UZUNKAYA S. (SBK LINZ)		
		PTS	
3	 GALATEANU D. (SBK LINZ)		 GALATEANU D. (SBK LINZ)
		6	
4	 WIENERROITHER L. (KARATE SEEWALCHEN)		
		0	
5	 UZUNKAYA S. (SBK LINZ)		 WIENERROITHER L. (KARATE SEEWALCHEN)
6	 WIENERROITHER L. (KARATE SEEWALCHEN)		





1. GALATEANU DAVID (SBK LINZ)
2. WIENERROITHER LUKAS (KARATE SEEWALCHEN)

Referees:			



OÖ Landesmeisterschaft und OÖ
Meisterschaft 2024 - 2024-04-13

Offizielle Ergebnisliste

Kumite Individual male U16 -57			
1	GALATEANU DAVID		AUT - AUSTRIA
2	WIENERROITHER LUKAS		AUT - AUSTRIA

KUMITE INDIVIDUAL MALE U16 -63









Kumite Individual male U16 -63 - Round Robin (jeder gegen jeden)

OÖ Landesmeisterschaft und OÖ Meisterschaft 2024, Europaplatz 5, 4663 Laakirchen, AUT

2024-04-13

Tatami
2 14:55

Pool
1/1

1	 CHEBAN O. (LZOÖ)	6	 CHEBAN O. (LZOÖ)
2	 SAKANOVIC A. (WELS)	0	
	PTS		
3	 CHEBAN O. (LZOÖ)	9	 CHEBAN O. (LZOÖ)
4	 BOGAD P. (KARATE SEEWALCHEN)	0	
	PTS		
5	 SAKANOVIC A. (WELS)	10	 SAKANOVIC A. (WELS)
6	 BOGAD P. (KARATE SEEWALCHEN)	1	





1. CHEBAN OLEKSANDR (LZOÖ)
2. SAKANOVIC ADIN (WELS)
3. BOGAD PATRICK (KARATE SEEWALCHEN)

Referees:			



OÖ Landesmeisterschaft und OÖ
Meisterschaft 2024 - 2024-04-13

Offizielle Ergebnisliste

Kumite Individual male U16 -63			
1	CHEBAN OLEKSANDR		AUT - AUSTRIA
2	SAKANOVIC ADIN		AUT - AUSTRIA
3	BOGAD PATRICK		AUT - AUSTRIA

KUMITE INDIVIDUAL MALE U18 -76

Kumite Individual male U18 -76 - Round Robin (jeder gegen jeden)

OÖ Landesmeisterschaft und OÖ Meisterschaft 2024, Europaplatz 5, 4663 Laakirchen, AUT

2024-04-13

Tatami

3 15:10

Pool

1/1

1	 WINTERSPERGER L. (KARATE SBK NEUHOFEN)	1	 WINTERSPERGER L. (KARATE SBK NEUHOFEN)
2	 FORTNER N. (SBK LINZ)	0	
	PTS		
3	 WINTERSPERGER L. (KARATE SBK NEUHOFEN)	8	 WINTERSPERGER L. (KARATE SBK NEUHOFEN)
4	 KRAWCZYK D. (SHIN TAI KARATE VÖCKLABRUCK)	0	
	PTS		
5	 FORTNER N. (SBK LINZ)	6	 FORTNER N. (SBK LINZ)
6	 KRAWCZYK D. (SHIN TAI KARATE VÖCKLABRUCK)	0	
	PTS		





1. WINTERSPERGER LORENZ (KARATE SBK NEUHOFEN)
2. FORTNER NIKLAS (SBK LINZ)
3. KRAWCZYK DAWID (SHIN TAI KARATE VÖCKLABRUCK)

Referees:			



OÖ Landesmeisterschaft und OÖ
Meisterschaft 2024 - 2024-04-13

Offizielle Ergebnisliste

Kumite Individual male U18 -76			
1	WINTERSPERGER LORENZ		AUT - AUSTRIA
2	FORTNER NIKLAS		AUT - AUSTRIA
3	KRAWCZYK DAWID		AUT - AUSTRIA

KUMITE INDIVIDUAL MALE U21
OPEN

Kumite Individual male U21 Open - Round Robin (jeder gegen jeden)

OÖ Landesmeisterschaft und OÖ Meisterschaft 2024, Europaplatz 5, 4663 Laakirchen, AUT

2024-04-13

Tatami
3 14:40

Pool
1/1





1. GRIGORASENCO NICHITA (LZOÖ)
2. HUSKIC DENIS (SBK LINZ)
3. NAGEL RAPHAEL (LENZING)

Referees:			



OÖ Landesmeisterschaft und OÖ
Meisterschaft 2024 - 2024-04-13

Offizielle Ergebnisliste

Kumite Individual male U21 Open			
1	GRIGORASENCO NICHITA		AUT - AUSTRIA
2	HUSKIC DENIS		AUT - AUSTRIA
3	NAGEL RAPHAEL		AUT - AUSTRIA

KUMITE TEAM FEMALE SEN









Kumite Team female Sen - Round Robin (jeder gegen jeden)

OÖ Landesmeisterschaft und OÖ Meisterschaft 2024, Europaplatz 5, 4663 Laakirchen, AUT

2024-04-13

Tatami
2 17:10

Pool
1/1

1	 Shin Tai (Shin Tai Karate Vöcklabruck)	 Askö SeiBuKan Linz (SBK Linz)
2	 Askö SeiBuKan Linz (SBK Linz)	
3	 Shin Tai (Shin Tai Karate Vöcklabruck)	 Askö SeiBuKan Linz (SBK Linz)
4	 Askö SeiBuKan Linz (SBK Linz)	
5	 Askö SeiBuKan Linz (SBK Linz)	 Askö SeiBuKan Linz (SBK Linz)
6	 Askö SeiBuKan Linz (SBK Linz)	

PTS
17





1. ASKÖ SEIBUKAN LINZ (SBK LINZ)
2. ASKÖ SEIBUKAN LINZ (SBK LINZ)

Referees:			



OÖ Landesmeisterschaft und OÖ
Meisterschaft 2024 - 2024-04-13

Offizielle Ergebnisliste

Kumite Team female Sen			
1	ASKÖ SEIBUKAN LINZ - FUCHS ANNA - BERISHA NATALIE - ACKERBAUER SABINE - IKIC VANESSA - POINTNER LISA		AUT - AUSTRIA
2	ASKÖ SEIBUKAN LINZ - STICHT PATRICIA - SCHLÖGL ANDREA - AUSSERWÖGER CORINA - ACKERBAUER SABINE - ÖLLINGER ANNA		AUT - AUSTRIA

KUMITE TEAM MALE SEN

1		3	
2		0	
	PTS		
3		0	
4		0	
5		0	
	PTS		
6		3	





1. ASKÖ SEIBUKAN LINZ (SBK LINZ)
2. TEAM SALZKAMMERGUT (SHIN TAI KARATE VÖCKLABRUCK)
3. ASKÖ SEIBUKAN LINZ (SBK LINZ)

Referees:			









OÖ Landesmeisterschaft und OÖ
Meisterschaft 2024 - 2024-04-13



Offizielle Ergebnisliste



Kumite Team male Sen			
1	ASKÖ SEIBUKAN LINZ - HERAC ELVEDIN - HAGLEITNER OLIVER - FEILMAYR RAPHAEL - BÖHEIM MARTIN - HUSKIC DENIS		AUT - AUSTRIA
2	TEAM SALZKAMMERGUT - GROSSHAUPT ERIK - KLINGLMAYR GÜNTHER - NAGL GREGOR - SCHELL THOMAS - WEINBERGER STEFAN		AUT - AUSTRIA
3	ASKÖ SEIBUKAN LINZ - WIESINGER MARKUS - REINSPRECHT STEPHAN - LADSTÄTTER ALEXANDER - BACHLMAYR MICHAEL		AUT - AUSTRIA

Ergebnisliste OÖLM



Kata Individual female Seniors				
1	POPOVA VARVARA	KARATEDO WELS		AUT - AUSTRIA
2	BERISHA NATALIE	ASKÖ SEIBUKAN LINZ		AUT - AUSTRIA
3	MACANOVIC MAJDA	SPORTVEREIN KARATE-DO MARCHTRENK		AUT - AUSTRIA
3	FUCHS ANNA	ASKÖ SEIBUKAN LINZ		AUT - AUSTRIA
5	GALATEANU EVELYN	ASKÖ SEIBUKAN LINZ		AUT - AUSTRIA
5	STICHT PATRICIA	ASKÖ SEIBUKAN LINZ		AUT - AUSTRIA
7	GRILL MELANIE	SPORTUNION KARATE GMUNDEN		AUT - AUSTRIA



Kata Individual male Seniors				
1	VLACIC ALEKSANDAR	SPORTUNION SCHWANENSTADT		AUT - AUSTRIA
2	GROSSHAUPT ERIK	SPORTUNION KARATE GMUNDEN		AUT - AUSTRIA
3	VLACIC STEFAN	SPORTUNION SCHWANENSTADT		AUT - AUSTRIA
3	NAGL GREGOR	SHIN TAI KARATE VÖCKLABRUCK		AUT - AUSTRIA
5	HEMETSBERGER OSKAR	SPORTUNION ATTERGAU		AUT - AUSTRIA
5	GROSSHAUPT LUDWIG	SPORTUNION KARATE GMUNDEN		AUT - AUSTRIA
7	HERAC EDVIN	SPORTVEREIN KARATE-DO MARCHTRENK		AUT - AUSTRIA



Kata Team female Seniors				
1	ASKÖ SEIBUKAN LINZ TEAM 3 - BERISHA NATALIE - FUCHS ANNA - STICHT PATRICIA	ASKÖ SEIBUKAN LINZ		AUT - AUSTRIA
2	SPORTUNION KARATE GMUNDEN - AICHSTILL DESIREE - GRILL MELANIE - OBEREIGNER ANJA	SPORTUNION KARATE GMUNDEN		AUT - AUSTRIA
3	ATSV SEEWALCHEN - SEKTION KARATE - ABLINGER BIRGIT - KOPACKA-RIEDL KIM - ZEILBERGER ELKE	ATSV SEEWALCHEN - SEKTION KARATE		AUT - AUSTRIA



Kumite Individual female Seniors +68				
1	STICHT PATRICIA	ASKÖ SEIBUKAN LINZ		AUT - AUSTRIA
2	BERISHA NATALIE	ASKÖ SEIBUKAN LINZ		AUT - AUSTRIA
3	BLÜMELHUBER BIANCA	ASKÖ KARATE STEYR		AUT - AUSTRIA

Ergebnisliste OÖLM



Kumite Individual female Seniors -68				
1	POINTNER LISA	ASKÖ SEIBUKAN LINZ		AUT - AUSTRIA
2	FUCHS ANNA	ASKÖ SEIBUKAN LINZ		AUT - AUSTRIA
3	JONAS SARAH	SHIN TAI KARATE VÖCKLABRUCK		AUT - AUSTRIA

Kumite Individual male Seniors +84				
1	HERAC ELVEDIN	ASKÖ SEIBUKAN LINZ		AUT - AUSTRIA
2	WEINBERGER STEFAN	SHIN TAI KARATE VÖCKLABRUCK		AUT - AUSTRIA
3	YANARDAG FERDI	ASKÖ KARATE STEYR		AUT - AUSTRIA



Kumite Individual male Seniors -67				
1	HUSKIC DENIS	ASKÖ SEIBUKAN LINZ		AUT - AUSTRIA
2	WIESINGER MARKUS	ASKÖ SEIBUKAN LINZ		AUT - AUSTRIA
3	GROSSHAUPT ERIK	SPORTUNION KARATE GMUNDEN		AUT - AUSTRIA

Kumite Individual male Seniors -75				
1	GRIGORASENCO NICHITA	LZ OBERÖSTERREICH		AUT - AUSTRIA
2	NAGL GREGOR	SHIN TAI KARATE VÖCKLABRUCK		AUT - AUSTRIA
3	BACHLMAYR MICHAEL	ASKÖ SEIBUKAN LINZ		AUT - AUSTRIA





Kumite Individual male Seniors -84				
1	VLACIC ALEKSANDAR	SPORTUNION SCHWANENSTADT		AUT - AUSTRIA
2	VLACIC STEFAN	SPORTUNION SCHWANENSTADT		AUT - AUSTRIA
3	REINSPRECHT STEPHAN	ASKÖ SEIBUKAN LINZ		AUT - AUSTRIA
3	FEILMAYR RAPHAEL	ASKÖ SEIBUKAN LINZ		AUT - AUSTRIA

Kumite Team female Sen				
1	ASKÖ SEIBUKAN LINZ - FUCHS ANNA - BERISHA NATALIE - ACKERBAUER SABINE - IKIC VANESSA - POINTNER LISA	ASKÖ SEIBUKAN LINZ		AUT - AUSTRIA
2	ASKÖ SEIBUKAN LINZ - STICHT PATRICIA - SCHLÖGL ANDREA - AUSSERWÖGER CORINA - ACKERBAUER SABINE - ÖLLINGER ANNA	ASKÖ SEIBUKAN LINZ		AUT - AUSTRIA

Ergebnisliste OÖLM

Kumite Team male Sen					
1	ASKÖ SEIBUKAN LINZ - HERAC ELVEDIN - HAGLEITNER OLIVER - FEILMAYR RAPHAEL - BÖHEIM MARTIN - HUSKIC DENIS	ASKÖ SEIBUKAN LINZ		AUT - AUSTRIA	
2	TEAM SALZKAMMERGUT - GROSSHAUPT ERIK - KLINGLMAYR GÜNTHER - NAGL GREGOR - SCHELL THOMAS - WEINBERGER STEFAN	SHIN TAI KARATE VÖCKLABRUCK		AUT - AUSTRIA	
3	ASKÖ SEIBUKAN LINZ - WIESINGER MARKUS - REINSPRECHT STEPHAN - LADSTÄTTER ALEXANDER - BACHLMAYR MICHAEL	ASKÖ SEIBUKAN LINZ		AUT - AUSTRIA	

Ergebnisliste OÖM







Kata Individual female Sen +35				
1	MACANOVIC MAJDA	SPORTVEREIN KARATE-DO MARCHTRENK		AUT - AUSTRIA
2	JUNG MICHAELA	SHIN TAI KARATE VÖCKLABRUCK		AUT - AUSTRIA
3	AUSSERWÖGER CORINA	ASKÖ SEIBUKAN LINZ		AUT - AUSTRIA
3	SHELL CARINA	SHIN TAI KARATE VÖCKLABRUCK		AUT - AUSTRIA
5	SCHLÖGL ANDREA	ASKÖ SEIBUKAN LINZ		AUT - AUSTRIA

Kata Individual female U10				
1	SHELL SOPHIA	SHIN TAI KARATE VÖCKLABRUCK		AUT - AUSTRIA
2	SKENDEROVIC LEONA	SHIN TAI KARATE VÖCKLABRUCK		AUT - AUSTRIA
3	NOORI LENIA	ASKÖ SEIBUKAN LINZ		AUT - AUSTRIA
3	MACANOVIC EMA	SPORTVEREIN KARATE-DO MARCHTRENK		AUT - AUSTRIA
5	RIEDL LILIA	ATSV SEEWALCHEN - SEKTION KARATE		AUT - AUSTRIA
5	TRAN LEONIE	ASKÖ SEIBUKAN LINZ		AUT - AUSTRIA
7	MARES MIRIAM	ASKÖ NEUHOFEN KARATE SEIBUKAN		AUT - AUSTRIA
7	HILJUK HELENA	SPORTUNION SCHWANENSTADT		AUT - AUSTRIA

Kata Individual female U12				
1	MITRI JENNIFER	ASKÖ SEIBUKAN LINZ		AUT - AUSTRIA
2	WENDLER MIA DESIREÉ	DSG UNION SANKT MARTIN/TRAUN		AUT - AUSTRIA
3	SALZMANN IDA	ASKÖ NEUHOFEN KARATE SEIBUKAN		AUT - AUSTRIA
3	HINTERBERGER MIA	UNION KARATECLUB GRIESKIRCHEN		AUT - AUSTRIA
5	STEININGER CHARLOTTE	ASKÖ SEIBUKAN LINZ		AUT - AUSTRIA
5	ISLAMOVIĆ EMIRA	ASKÖ SEIBUKAN LINZ		AUT - AUSTRIA
7	KASTENHUBER JULIA	SPORTUNION SCHWANENSTADT		AUT - AUSTRIA
7	SCHÖBER ELISABETH	ASKÖ SEIBUKAN LINZ		AUT - AUSTRIA
9	KANURIC ELENA	KARATEDO WELS		AUT - AUSTRIA
9	MUJANOVIC EMINA	SPORTUNION SCHWANENSTADT		AUT - AUSTRIA

Kata Individual female U14				
1	WAHL SARAH	ASKÖ NEUHOFEN KARATE SEIBUKAN		AUT - AUSTRIA

Ergebnisliste OÖM

2	COVIC SAURA	SPORTVEREIN KARATE-DO MARCHTRENK		AUT - AUSTRIA	
3	ASCHENBERGER SOPHIA	SPORTUNION KARATE GAMPERN		AUT - AUSTRIA	
3	HUSIDIC DAJRA	SPORTVEREIN KARATE-DO MARCHTRENK		AUT - AUSTRIA	
5	JUKIC EMINA	SPORTUNION SCHWANENSTADT		AUT - AUSTRIA	
5	BEGOVIC ANELI	SPORTVEREIN KARATE-DO MARCHTRENK		AUT - AUSTRIA	
7	HUBER JESSICA	SPORTUNION SCHWANENSTADT		AUT - AUSTRIA	
7	HÜTTNER VIKTORIA	SHOTOKAN KARATE SPORTUNION ALTMÜNSTER		AUT - AUSTRIA	

Kata Individual female U16

1	SAKANOVIC ADNA	KARATEDO WELS		AUT - AUSTRIA	
2	DINSTL LINDA	ASKÖ NEUHOFFEN KARATE SEIBUKAN		AUT - AUSTRIA	
3	MEMIC HANA	SPORTVEREIN KARATE-DO MARCHTRENK		AUT - AUSTRIA	
3	ABLINGER SARAH	ATSV SEEWALCHEN - SEKTION KARATE		AUT - AUSTRIA	
5	HAUSER SOPHIE	SPORTUNION KARATE GMUNDEN		AUT - AUSTRIA	
5	HUBER SOPHIA-MARIE	UNION KARATECLUB GRIESKIRCHEN		AUT - AUSTRIA	
7	BEGOVIC NADIJA	SPORTVEREIN KARATE-DO MARCHTRENK		AUT - AUSTRIA	
7	WINKLER ALINA	SHIN TAI KARATE VÖCKLABRUCK		AUT - AUSTRIA	

Kata Individual female U18







1	TREML ANNA	SHOTOKAN KARATE SPORTUNION ALTMÜNSTER		AUT - AUSTRIA	
2	GALATEANU EVELYN	ASKÖ SEIBUKAN LINZ		AUT - AUSTRIA	
3	ISLAMOVIC AJLA	ASKÖ SEIBUKAN LINZ		AUT - AUSTRIA	
4	GRUDKE LINDA	SHIN TAI KARATE VÖCKLABRUCK		AUT - AUSTRIA	

Kata Individual female U21

1	JONAS SARAH	SHIN TAI KARATE VÖCKLABRUCK		AUT - AUSTRIA	
2	FEICHTINGER VERONIKA	SPORTUNION KARATE GMUNDEN		AUT - AUSTRIA	
3	OBEREIGNER ANJA	SPORTUNION KARATE GMUNDEN		AUT - AUSTRIA	

Ergebnisliste OÖM

Kata Individual male Sen +45					
1	DICKINGER CHRISTIAN	SHOTOKAN KARATE SPORTUNION ALTMÜNSTER		AUT - AUSTRIA	
2	HEMETSBERGER OSKAR	SPORTUNION ATTERGAU		AUT - AUSTRIA	
3	GROSSHAUPT LUDWIG	SPORTUNION KARATE GMUNDEN		AUT - AUSTRIA	
3	REINSPRECHT STEPHAN	ASKÖ SEIBUKAN LINZ		AUT - AUSTRIA	

Kata Individual male Sen+35					
1	DICKINGER CHRISTIAN	SHOTOKAN KARATE SPORTUNION ALTMÜNSTER		AUT - AUSTRIA	
2	GROSSHAUPT LUDWIG	SPORTUNION KARATE GMUNDEN		AUT - AUSTRIA	
3	BACHLMAYR MICHAEL	ASKÖ SEIBUKAN LINZ		AUT - AUSTRIA	
3	MEHMEDAGIC AMIR	SPORTUNION ATTERGAU		AUT - AUSTRIA	
5	SCHULZ RALPH MARTIN	SPORTUNION ATTERGAU		AUT - AUSTRIA	
5	REINSPRECHT STEPHAN	ASKÖ SEIBUKAN LINZ		AUT - AUSTRIA	

Kata Individual male U10					
1	MARKOVIC ANDREJ	ASKÖ SEIBUKAN LINZ		AUT - AUSTRIA	
2	REICHL FINN	ASKÖ NEUHOFEN KARATE SEIBUKAN		AUT - AUSTRIA	
3	ODOBASIC HARIS	ATSV LENZING SEKTION KARATE		AUT - AUSTRIA	
3	WURM MATTHIAS	ASKÖ NEUHOFEN KARATE SEIBUKAN		AUT - AUSTRIA	
5	RIEGER JULIAN	KARATEDO WELS		AUT - AUSTRIA	
5	HEMETSBERGER MAXIMILIAN	SHIN TAI KARATE VÖCKLABRUCK		AUT - AUSTRIA	
7	ZIERLER RICHARD	SHOTOKAN KARATE SPORTUNION ALTMÜNSTER		AUT - AUSTRIA	
7	ROITHER MICHAEL	ATSV LENZING SEKTION KARATE		AUT - AUSTRIA	

Kata Individual male U12					
1	HEINISCH LEON	ASKÖ SEIBUKAN LINZ		AUT - AUSTRIA	
2	ASCHENBERGER RAPHAEL	SPORTUNION KARATE GAMPERN		AUT - AUSTRIA	
3	CHEN CHENKAI	ASKÖ SEIBUKAN LINZ		AUT - AUSTRIA	
3	MALA HAMZA HEM	SHINDO ASKÖ LINZ AUHOF		AUT - AUSTRIA	
5	WIMMER JONAS	SHIN TAI KARATE VÖCKLABRUCK		AUT - AUSTRIA	
5	REICHARDT SIMON	KARATEDO WELS		AUT - AUSTRIA	
7	SUNJE ADRIANO	KARATEDO WELS		AUT - AUSTRIA	

Ergebnisliste OÖM

7	MEHMEDAGIC ANES	SPORTUNION ATTERGAU		AUT - AUSTRIA	
---	-----------------	------------------------	---	---------------	--

Kata Individual male U14

1	TRUMIC AHMED	SPORTVEREIN KARATE-DO MARCHTRENK		AUT - AUSTRIA	
2	GADERER JULIAN	ASKÖ SEIBUKAN LINZ		AUT - AUSTRIA	
3	LEITNER ALEXANDER	SHOTOKAN KARATE SPORTUNION ALTMÜNSTER		AUT - AUSTRIA	
3	SEDEQY JOSEF	ASKÖ SEIBUKAN LINZ		AUT - AUSTRIA	
5	RIEDLER JONAS	SHIN TAI KARATE VÖCKLABRUCK		AUT - AUSTRIA	
5	HITTENBERGER CHRISTOPHER MARTIN	SPORTUNION ATTERGAU		AUT - AUSTRIA	
7	CENANOVIC LEON	SPORTUNION SCHWANENSTADT		AUT - AUSTRIA	



Kata Individual male U16

1	SAKANOVIC ADIN	KARATEDO WELS		AUT - AUSTRIA	
2	ACKERBAUER ANDREAS	ASKÖ SEIBUKAN LINZ		AUT - AUSTRIA	
3	MAYR WERNER	ASKÖ SEIBUKAN LINZ		AUT - AUSTRIA	
3	HOSSEINI SARO	ATSV LENZING SEKTION KARATE		AUT - AUSTRIA	
5	WIENERROITHER LUKAS	ATSV SEEWALCHEN - SEKTION KARATE		AUT - AUSTRIA	
5	ZELLINGER LEON	SHOTOKAN KARATE SPORTUNION ALTMÜNSTER		AUT - AUSTRIA	
7	GALATEANU DAVID	ASKÖ SEIBUKAN LINZ		AUT - AUSTRIA	

Kata Individual male U21

1	HUSKIC DENIS	ASKÖ SEIBUKAN LINZ		AUT - AUSTRIA	
2	FORTNER NIKLAS	ASKÖ SEIBUKAN LINZ		AUT - AUSTRIA	
3	SALAJI ARGJENT	KARATEDO WELS		AUT - AUSTRIA	
3	NAGEL RAPHAEL	ATSV LENZING SEKTION KARATE		AUT - AUSTRIA	
5	EGGL JOHANNES	ATSV LENZING SEKTION KARATE		AUT - AUSTRIA	
5	SCHACHL NIKLAS	SPORTUNION ATTERGAU		AUT - AUSTRIA	





Kata Team female U12

1	ASKÖ SEIBUKAN LINZ - HUSKIC DIANA - ISLAMOVIC EMIRA - MITRI JENNIFER - MÖRIXBAUER LEILA	ASKÖ SEIBUKAN LINZ		AUT - AUSTRIA	
2	ASKÖ SEIBUKAN LINZ	ASKÖ SEIBUKAN LINZ		AUT - AUSTRIA	

Ergebnisliste OÖM

	- CAUSEVIC MELEK_EIWA - NOORI LENIA - TRAN LEONIE				
3	ATSV LENZING SEKTION KARATE 1 - NEUDORFER ELLA - ROITHER MIA - SEEBAUER FRANZISKA	ATSV LENZING SEKTION KARATE		AUT - AUSTRIA	
4	SHIN TAI KARATE VÖCKLABRUCK 3 - BEKAS ARYANA - HACKL LIESELOTTE - PEHLIC ALISA	SHIN TAI KARATE VÖCKLABRUCK		AUT - AUSTRIA	

Kata Team female U16





1	UNION KARATECLUB GRIESKIRCHEN - HINTERBERGER MIA - HUBER SOPHIA-MARIE - HÖRMANDINGER ELINA	UNION KARATECLUB GRIESKIRCHEN		AUT - AUSTRIA	
2	ALTMÜNSTER 2 - HÜTTNER VIKTORIA - JANECEK ELINA - MITTENDORFER CHRISTINA	SHOTOKAN KARATE SPORTUNION ALTMÜNSTER		AUT - AUSTRIA	
3	SPORTVEREIN KARATE-DO MARCHTRENK - TRUMIC AMINA - JELICA GABRIELA - COVIC SAURA	SPORTVEREIN KARATE-DO MARCHTRENK		AUT - AUSTRIA	
3	SHIN TAI KARATE VÖCKLABRUCK 2 - WEINBERGER PIA - JUNG LENA - GÜNTHER MIA	SHIN TAI KARATE VÖCKLABRUCK		AUT - AUSTRIA	
5	SPORTVEREIN KARATE-DO MARCHTRENK - TRUMIC SUMEJA - BEGOVIC NADIJA - MEMIC HANA	SPORTVEREIN KARATE-DO MARCHTRENK		AUT - AUSTRIA	





Kata Team male U12





1	ASKÖ SEIBUKAN LINZ - CHEN CHENKAI - HEINISCH LEON - MARKOVIC ANDREJ	ASKÖ SEIBUKAN LINZ		AUT - AUSTRIA	
2	UNION KARATECLUB GRIESKIRCHEN - FLATTINGER BEN - MÜHLBAUER ALEXANDER - SCHINDLER LAURENZ	UNION KARATECLUB GRIESKIRCHEN		AUT - AUSTRIA	
3	SHIN TAI KARATE VÖCKLABRUCK - WIMMER JONAS - STROBLMAYR SAMUEL - HEMETSBERGER MAXIMILIAN	SHIN TAI KARATE VÖCKLABRUCK		AUT - AUSTRIA	
4	ATSV LENZING SEKTION KARATE 2 - ODOBASIC HARIS - ROITHER MICHAEL - SCHMID MORITZ	ATSV LENZING SEKTION KARATE		AUT - AUSTRIA	

Ergebnisliste OÖM

Kata Team male U21				
1	ATSV LENZING SEKTION KARATE 3 - EGGL JOHANNES - HOSSEINI SARO - NAGEL RAPHAEL	ATSV LENZING SEKTION KARATE		AUT - AUSTRIA
2	ASKÖ SEIBUKAN LINZ - ACKERBAUER ANDREAS - GALATEANU DAVID - MAYR WERNER	ASKÖ SEIBUKAN LINZ		AUT - AUSTRIA
3	ASKÖ SEIBUKAN LINZ - GADERER JULIAN - SEDEQY JOSEF - TRAN TOMMY	ASKÖ SEIBUKAN LINZ		AUT - AUSTRIA

Kumite Individual Female Seniors 35+ Open				
1	JUNG MICHAELA	SHIN TAI KARATE VÖCKLABRUCK		AUT - AUSTRIA
2	SCHLÖGL ANDREA	ASKÖ SEIBUKAN LINZ		AUT - AUSTRIA
3	SHELL CARINA	SHIN TAI KARATE VÖCKLABRUCK		AUT - AUSTRIA
3	ACKERBAUER SABINE	ASKÖ SEIBUKAN LINZ		AUT - AUSTRIA

Kumite Individual Male Seniors 35+ Open				
1	SHELL THOMAS	SHIN TAI KARATE VÖCKLABRUCK		AUT - AUSTRIA
2	REINSPRECHT STEPHAN	ASKÖ SEIBUKAN LINZ		AUT - AUSTRIA
3	BACHLMAYR MICHAEL	ASKÖ SEIBUKAN LINZ		AUT - AUSTRIA
3	YANARDAG FERDI	ASKÖ KARATE STEYR		AUT - AUSTRIA
5	WIESINGER MARKUS	ASKÖ SEIBUKAN LINZ		AUT - AUSTRIA





Kumite Individual female U10				
1	SHELL SOPHIA	SHIN TAI KARATE VÖCKLABRUCK		AUT - AUSTRIA
2	SKENDEROVIC LEONA	SHIN TAI KARATE VÖCKLABRUCK		AUT - AUSTRIA
3	HACKL LIESELOTTE	SHIN TAI KARATE VÖCKLABRUCK		AUT - AUSTRIA
3	BEKAS ARYANA	SHIN TAI KARATE VÖCKLABRUCK		AUT - AUSTRIA
5	NOORI LENIA	ASKÖ SEIBUKAN LINZ		AUT - AUSTRIA

Kumite Individual female U12				
1	SALZMANN IDA	ASKÖ NEUHOFEN KARATE SEIBUKAN		AUT - AUSTRIA
2	ISLAMOVIC EMIRA	ASKÖ SEIBUKAN LINZ		AUT - AUSTRIA
3	HUSKIC DIANA	ASKÖ SEIBUKAN LINZ		AUT - AUSTRIA
3	WENDLER MIA DESIREÉ	DSG UNION SANKT MARTIN/TRAUN		AUT - AUSTRIA





Ergebnisliste OÖM

5	PEHLIC ALISA	SHIN TAI KARATE VÖCKLABRUCK		AUT - AUSTRIA	
7	MITRI JENNIFER	ASKÖ SEIBUKAN LINZ		AUT - AUSTRIA	





Kumite Individual female U14

1	GÜNTHER MIA	SHIN TAI KARATE VÖCKLABRUCK		AUT - AUSTRIA	
2	COVIC SAURA	SPORTVEREIN KARATE-DO MARCHTRENK		AUT - AUSTRIA	
3	JUNG LENA	SHIN TAI KARATE VÖCKLABRUCK		AUT - AUSTRIA	
4	HUSIDIC DAJRA	SPORTVEREIN KARATE-DO MARCHTRENK		AUT - AUSTRIA	

Kumite Individual female U16 +54

1	GÖBELHAIDER STEPHANIE	ASKÖ KARATE STEYR		AUT - AUSTRIA	
2	WEINBERGER PIA	SHIN TAI KARATE VÖCKLABRUCK		AUT - AUSTRIA	
3	WINKLER ALINA	SHIN TAI KARATE VÖCKLABRUCK		AUT - AUSTRIA	
4	HITSCH SOPHIE	SHIN TAI KARATE VÖCKLABRUCK		AUT - AUSTRIA	

Kumite Individual female U16 -54

1	SAKANOVIC ADNA	KARATEDO WELS		AUT - AUSTRIA	
2	ABLINGER SARAH	ATSV SEEWALCHEN - SEKTION KARATE		AUT - AUSTRIA	
3	DINSTL LINDA	ASKÖ NEUHOFEN KARATE SEIBUKAN		AUT - AUSTRIA	
4	TURANOVIC LEJLA	ASKÖ KARATE STEYR		AUT - AUSTRIA	

Kumite Individual female U18 -53

1	GALATEANU EVELYN	ASKÖ SEIBUKAN LINZ		AUT - AUSTRIA	
2	ISLAMOVIC AJLA	ASKÖ SEIBUKAN LINZ		AUT - AUSTRIA	
3	GRUDKE LINDA	SHIN TAI KARATE VÖCKLABRUCK		AUT - AUSTRIA	

Kumite Individual male U10

1	REICHL FINN	ASKÖ NEUHOFEN KARATE SEIBUKAN		AUT - AUSTRIA	
2	MARKOVIC ANDREJ	ASKÖ SEIBUKAN LINZ		AUT - AUSTRIA	
3	ZEC DANIS	DSG UNION SANKT MARTIN/TRAUN		AUT - AUSTRIA	
4	HEMETSBERGER MAXIMILIAN	SHIN TAI KARATE VÖCKLABRUCK		AUT - AUSTRIA	

Kumite Individual male U12

1	MALA HAMZA HEM	SHINDO ASKÖ LINZ AUHOF		AUT - AUSTRIA	
---	----------------	---------------------------	---	---------------	--

Ergebnisliste OÖM

2	HUBER NICLAS	ASKÖ NEUHOFEN KARATE SEIBUKAN		AUT - AUSTRIA	
3	HEINISCH LEON	ASKÖ SEIBUKAN LINZ		AUT - AUSTRIA	
3	BIHORAC MUHAMED	DSG UNION SANKT MARTIN/TRAUN		AUT - AUSTRIA	
5	TIJANOVIC ADIN	DSG UNION SANKT MARTIN/TRAUN		AUT - AUSTRIA	
5	WIMMER JONAS	SHIN TAI KARATE VÖCKLABRUCK		AUT - AUSTRIA	
7	THALER DOMINIK	SPORTUNION KARATE GMUNDEN		AUT - AUSTRIA	
7	STROBLMAYR SAMUEL	SHIN TAI KARATE VÖCKLABRUCK		AUT - AUSTRIA	





Kumite Individual male U14

1	BURGER DIEGO	DSG UNION SANKT MARTIN/TRAUN		AUT - AUSTRIA	
2	KAPELLER MORITZ	ASKÖ KARATE STEYR		AUT - AUSTRIA	
3	RIEDLER JONAS	SHIN TAI KARATE VÖCKLABRUCK		AUT - AUSTRIA	
3	BECK SEBASTIAN	ASKÖ KARATE STEYR		AUT - AUSTRIA	
5	KADIC DAVUD	DSG UNION SANKT MARTIN/TRAUN		AUT - AUSTRIA	
5	HITTENBERGER CHRISTOPHER MARTIN	SPORTUNION ATTERGAU		AUT - AUSTRIA	

Kumite Individual male U16 +70

1	MAYR WERNER	ASKÖ SEIBUKAN LINZ		AUT - AUSTRIA	
2	HOSSEINI SARO	ATSV LENZING SEKTION KARATE		AUT - AUSTRIA	

Kumite Individual male U16 -52

1	ACKERBAUER ANDREAS	ASKÖ SEIBUKAN LINZ		AUT - AUSTRIA	
2	HANKOWETZ JAKOB	ASKÖ NEUHOFEN KARATE SEIBUKAN		AUT - AUSTRIA	
3	VOGLHUBER ALEXANDER	ATSV SEEWALCHEN - SEKTION KARATE		AUT - AUSTRIA	
4	HOLZINGER ALEXANDER	SHIN TAI KARATE VÖCKLABRUCK		AUT - AUSTRIA	

Kumite Individual male U16 -57



1	GALATEANU DAVID	ASKÖ SEIBUKAN LINZ		AUT - AUSTRIA	
2	WIENERROITHER LUKAS	ATSV SEEWALCHEN - SEKTION KARATE		AUT - AUSTRIA	

Kumite Individual male U16 -63

1	CHEBAN OLEKSANDR	LZ OBERÖSTERREICH		AUT - AUSTRIA	
2	SAKANOVIC ADIN	KARATEDO WELS		AUT - AUSTRIA	
3	BOGAD PATRICK	ATSV SEEWALCHEN - SEKTION KARATE		AUT - AUSTRIA	

Ergebnisliste OÖM









Kumite Individual male U18 -76				
1	WINTERSPERGER LORENZ	ASKÖ NEUHOFEN KARATE SEIBUKAN		AUT - AUSTRIA
2	FORTNER NIKLAS	ASKÖ SEIBUKAN LINZ		AUT - AUSTRIA
3	KRAWCZYK DAWID	SHIN TAI KARATE VÖCKLABRUCK		AUT - AUSTRIA

Kumite Individual male U21 Open				
1	GRIGORASENCO NICHITA	LZ OBERÖSTERREICH		AUT - AUSTRIA
2	HUSKIC DENIS	ASKÖ SEIBUKAN LINZ		AUT - AUSTRIA
3	NAGEL RAPHAEL	ATSV LENZING SEKTION KARATE		AUT - AUSTRIA



OÖ Landesmeisterschaft und OÖ
Meisterschaft 2024 - 2024-04-13

















Medallenspiegel OÖLM

Rang	Verein	1. Platz	2. Platz	3. Platz
1	 ASKÖ SEIBUKAN LINZ, AUT	7	5	5
2	 SPORTUNION SCHWANENSTADT, AUT	2	1	1
3	 KARATEDO WELS, AUT	1	0	0
	 LZ OBERÖSTERREICH, AUT	1	0	0
5	 SHIN TAI KARATE VÖCKLABRUCK, AUT	0	3	2
6	 SPORTUNION KARATE GMUNDEN, AUT	0	2	1
7	 ASKÖ KARATE STEYR, AUT	0	0	2
8	 SPORTVEREIN KARATE-DO MARCHTRENK, AUT	0	0	1
	 ATSV SEEWALCHEN - SEKTION KARATE, AUT	0	0	1



OÖ Landesmeisterschaft und OÖ
Meisterschaft 2024 - 2024-04-13

Medaillenspiegel OÖM

Rang	Verein	1. Platz	2. Platz	3. Platz
1	 ASKÖ SEIBUKAN LINZ, AUT	10	13	13
2	 SHIN TAI KARATE VÖCKLABRUCK, AUT	6	4	11
3	 ASKÖ NEUHOFEN KARATE SEIBUKAN, AUT	4	4	3
4	 KARATEDO WELS, AUT	3	1	1
	 SHOTOKAN KARATE SPORTUNION ALTMÜNSTER, AUT	3	1	1
6	 SPORTVEREIN KARATE-DO MARCHTRENK, AUT	2	2	4
7	 LZ OBERÖSTERREICH, AUT	2	0	0
8	 ATSV LENZING SEKTION KARATE, AUT	1	1	5
9	 DSG UNION SANKT MARTIN/TRAUN, AUT	1	1	3
10	 ASKÖ KARATE STEYR, AUT	1	1	2
11	 UNION KARATECLUB GRIESKIRCHEN, AUT	1	1	1
12	 SHINDO ASKÖ LINZ AUHOF, AUT	1	0	1
13	 ATSV SEEWALCHEN - SEKTION KARATE, AUT	0	2	3
14	 SPORTUNION KARATE GMUNDEN, AUT	0	2	2
15	 SPORTUNION KARATE GAMPERN, AUT	0	1	1
	 SPORTUNION ATTERGAU, AUT	0	1	1