



# RESULTS BOOK

OFFENE LANDESMEISTERSCHAFT  
HESSEN UND RHEINLAND - PFALZ  
2024

2024.02.03 - 2024.02.03

SCHULSTRASSE 2, 69509 MÖRLENBACH

[WWW.SPORTDATA.ORG](http://WWW.SPORTDATA.ORG)





## TABLE OF CONTENTS

|  |     |
|--|-----|
| STATISTICS .....                         | 4   |
| JUGEND KATA JUNGEN .....                 | 6   |
| JUGEND KATA MÄDCHEN .....                | 14  |
| JUGEND KUMITE JUNGEN +70 KG .....        | 19  |
| JUGEND KUMITE JUNGEN -52 KG .....        | 24  |
| JUGEND KUMITE JUNGEN -57 KG .....        | 29  |
| JUGEND KUMITE JUNGEN -63 KG .....        | 34  |
| JUGEND KUMITE MÄDCHEN +61 KG .....       | 39  |
| JUGEND KUMITE MÄDCHEN -47 KG .....       | 44  |
| JUGEND KUMITE MÄDCHEN -54 KG .....       | 49  |
| JUGEND KUMITE MÄDCHEN -61 KG .....       | 54  |
| JUGEND KUMITE TEAM JUNGEN .....          | 59  |
| JUGEND KUMITE TEAM MÄDCHEN .....         | 64  |
| JUNIOREN KATA JUNGEN .....               | 69  |
| JUNIOREN KATA MÄDCHEN .....              | 74  |
| JUNIOREN KUMITE JUNGEN +76 KG .....      | 79  |
| JUNIOREN KUMITE JUNGEN -55 KG .....      | 84  |
| JUNIOREN KUMITE JUNGEN -61 KG .....      | 88  |
| JUNIOREN KUMITE JUNGEN -68 KG .....      | 92  |
| JUNIOREN KUMITE JUNGEN -76 KG .....      | 97  |
| JUNIOREN KUMITE MÄDCHEN +66 KG .....     | 102 |
| JUNIOREN KUMITE MÄDCHEN -66/-48 KG ..... | 106 |
| JUNIOREN KUMITE TEAM JUNGEN .....        | 110 |
| KATA MASTERKLASSE DAMEN Ü30/Ü35 .....    | 115 |
| KATA MASTERKLASSE DAMEN Ü45 .....        | 120 |
| KATA MASTERKLASSE DAMEN Ü55 .....        | 125 |
| KATA MASTERKLASSE HERREN Ü30/Ü35 .....   | 130 |
| KATA MASTERKLASSE HERREN Ü45 .....       | 135 |
| KATA MASTERKLASSE HERREN Ü55 .....       | 140 |

|  |     |
|--|-----|
| KATA MASTERKLASSE HERREN Ü65 .....             | 145 |
| KUMITE MASTERKLASSE DAMEN .....                | 150 |
| KUMITE MASTERKLASSE HERREN Ü35 +80 KG .....    | 154 |
| KUMITE MASTERKLASSE HERREN Ü35 -80 KG .....    | 159 |
| KUMITE MASTERKLASSE HERREN Ü45 +80 KG .....    | 164 |
| KUMITE MASTERKLASSE HERREN Ü45 -80 KG .....    | 168 |
| KUMITE MASTERKLASSE HERREN Ü55 +80 KG .....    | 172 |
| KUMITE MASTERKLASSE HERREN Ü55/Ü65 -80KG ..... | 176 |
| KUMITE TEAM HERREN LEISTUNGSKLASSE/U21 .....   | 181 |
| LEISTUNGSKLASSE KATA DAMEN .....               | 185 |
| LEISTUNGSKLASSE KATA HERREN .....              | 192 |
| LEISTUNGSKLASSE KATA TEAM MÄNNLICH .....       | 199 |
| LEISTUNGSKLASSE KATA TEAM WEIBLICH .....       | 203 |
| LEISTUNGSKLASSE KUMITE +68 KG WEIBLICH .....   | 207 |
| LEISTUNGSKLASSE KUMITE +84 KG MÄNNLICH .....   | 211 |
| LEISTUNGSKLASSE KUMITE -50 KG WEIBLICH .....   | 216 |
| LEISTUNGSKLASSE KUMITE -55 KG WEIBLICH .....   | 220 |
| LEISTUNGSKLASSE KUMITE -60 KG MÄNNLICH .....   | 225 |
| LEISTUNGSKLASSE KUMITE -61 KG WEIBLICH .....   | 229 |
| LEISTUNGSKLASSE KUMITE -67 KG MÄNNLICH .....   | 233 |
| LEISTUNGSKLASSE KUMITE -68 KG WEIBLICH .....   | 238 |
| LEISTUNGSKLASSE KUMITE -75 KG MÄNNLICH .....   | 243 |
| LEISTUNGSKLASSE KUMITE -84 KG MÄNNLICH .....   | 248 |
| LEISTUNGSKLASSE KUMITE TEAM WEIBLICH .....     | 253 |
| MASTERKLASSE KATA TEAM MIXED .....             | 258 |
| U21 KATA DAMEN .....                           | 262 |
| U21 KATA HERREN .....                          | 270 |
| U21 KUMITE DAMEN -50 KG .....                  | 275 |
| U21 KUMITE DAMEN -55 KG .....                  | 279 |
| U21 KUMITE DAMEN -61 KG .....                  | 283 |
| U21 KUMITE DAMEN -68/+68KG .....               | 287 |
| U21 KUMITE HERREN -60 KG .....                 | 291 |
| U21 KUMITE HERREN -67 KG .....                 | 295 |

|                                  |     |
|----------------------------------|-----|
| U21 KUMITE HERREN -75 KG.....    | 300 |
| U21 KUMITE HERREN -84/+84KG..... | 304 |
| OFFICIAL RESULTS.....            | 309 |
| MEDAL STANDING.....              | 321 |



# Offene Landesmeisterschaft Hessen und Rheinland - ..

GERMANY  
Schulstraße 2, 69509 Mörlenbach

2024.02.03 - 2024.02.03

## Statistics

Participating Countries: 1

Participating Regions: 8

Participating Team/Clubs: 66

|              | Competitors | Entries    |
|--------------|-------------|------------|
| Female       | 104         | 130        |
| Male         | 159         | 187        |
| <b>Total</b> | <b>263</b>  | <b>317</b> |

| Entries per Category               | Entries | Teams |
|------------------------------------|---------|-------|
| Jugend Kata Jungen                 | 13      | -     |
| Jugend Kata Mädchen                | 12      | -     |
| Jugend Kumite Jungen +70 kg        | 6       | -     |
| Jugend Kumite Jungen -52 kg        | 8       | -     |
| Jugend Kumite Jungen -57 kg        | 4       | -     |
| Jugend Kumite Jungen -63 kg        | 4       | -     |
| Jugend Kumite Mädchen +61 kg       | 3       | -     |
| Jugend Kumite Mädchen -47 kg       | 5       | -     |
| Jugend Kumite Mädchen -54 kg       | 5       | -     |
| Jugend Kumite Mädchen -61 kg       | 6       | -     |
| Jugend Kumite Team Jungen          | -       | 5     |
| Jugend Kumite Team Mädchen         | -       | 3     |
| Junioren Kata Jungen               | 7       | -     |
| Junioren Kata Mädchen              | 7       | -     |
| Junioren Kumite Jungen +76 kg      | 5       | -     |
| Junioren Kumite Jungen -55 kg      | 2       | -     |
| Junioren Kumite Jungen -61 kg      | 2       | -     |
| Junioren Kumite Jungen -68 kg      | 6       | -     |
| Junioren Kumite Jungen -76 kg      | 5       | -     |
| Junioren Kumite Mädchen +66 kg     | 2       | -     |
| Junioren Kumite Mädchen -66/-48 kg | 2       | -     |
| Junioren Kumite Team Jungen        | -       | 3     |
| Kata Masterklasse Damen Ü30/Ü35    | 5       | -     |
| Kata Masterklasse Damen Ü45        | 5       | -     |
| Kata Masterklasse Damen Ü55        | 5       | -     |
| Kata Masterklasse Herren Ü30/Ü35   | 3       | -     |
| Kata Masterklasse Herren Ü45       | 10      | -     |
| Kata Masterklasse Herren Ü55       | 13      | -     |
| Kata Masterklasse Herren Ü65       | 6       | -     |
| Kumite Masterklasse Damen          | 4       | -     |





# Offene Landesmeisterschaft Hessen und Rheinland -..

GERMANY  
Schulstraße 2, 69509 Mörlenbach

2024.02.03 - 2024.02.03

## Statistics

|  |            |           |
|--|------------|-----------|
| Kumite Masterklasse Herren Ü35 +80 kg    | 5          | -         |
| Kumite Masterklasse Herren Ü35 -80 kg    | 4          | -         |
| Kumite Masterklasse Herren Ü45 +80 kg    | 2          | -         |
| Kumite Masterklasse Herren Ü45 -80 kg    | 2          | -         |
| Kumite Masterklasse Herren Ü55 +80 kg    | 3          | -         |
| Kumite Masterklasse Herren Ü55/Ü65 -80kg | 4          | -         |
| Kumite Team Herren Leistungsklasse/U21   | -          | 4         |
| Leistungsklasse Kata Damen               | 24         | -         |
| Leistungsklasse Kata Herren              | 11         | -         |
| Leistungsklasse Kata Team männlich       | -          | 2         |
| Leistungsklasse Kata Team weiblich       | -          | 2         |
| Leistungsklasse Kumite +68 kg weiblich   | 2          | -         |
| Leistungsklasse Kumite +84 kg männlich   | 6          | -         |
| Leistungsklasse Kumite -50 kg weiblich   | 2          | -         |
| Leistungsklasse Kumite -55 kg weiblich   | 5          | -         |
| Leistungsklasse Kumite -60 kg männlich   | 3          | -         |
| Leistungsklasse Kumite -61 kg weiblich   | 2          | -         |
| Leistungsklasse Kumite -67 kg männlich   | 7          | -         |
| Leistungsklasse Kumite -68 kg weiblich   | 4          | -         |
| Leistungsklasse Kumite -75 kg männlich   | 6          | -         |
| Leistungsklasse Kumite -84 kg männlich   | 6          | -         |
| Leistungsklasse Kumite Team weiblich     | -          | 3         |
| Masterklasse Kata Team mixed             | -          | 2         |
| U21 Kata Damen                           | 10         | -         |
| U21 Kata Herren                          | 6          | -         |
| U21 Kata Team Damen                      | -          | 1         |
| U21 Kumite Damen -50 kg                  | 3          | -         |
| U21 Kumite Damen -55 kg                  | 3          | -         |
| U21 Kumite Damen -61 kg                  | 2          | -         |
| U21 Kumite Damen -68/+68kg               | 2          | -         |
| U21 Kumite Herren -60 kg                 | 2          | -         |
| U21 Kumite Herren -67 kg                 | 5          | -         |
| U21 Kumite Herren -75 kg                 | 2          | -         |
| U21 Kumite Herren -84/+84kg              | 4          | -         |
| <b>Totals:</b>                           | <b>292</b> | <b>25</b> |



# JUGEND KATA JUNGEN





# Offene Landesmeisterschaft Hessen und Rheinland -..

## ENTRIES BY WEIGHT CATEGORY

### Jugend Kata Jungen

As of 4 FEB 2024

| NOC Code | Gender | Name                   | Seeding |
|----------|--------|------------------------|---------|
| GER      | M      | Bier Philip            |         |
| GER      | M      | Billhardt Leon-Maurice |         |
| GER      | M      | Elkaiem Mohamed        |         |
| GER      | M      | Hussein Faraj          |         |
| GER      | M      | Jahn Leon Noel         |         |
| GER      | M      | Kabisch Leano          |         |
| GER      | M      | Münch Fabio            |         |
| GER      | M      | Pristawski Daniel      |         |
| GER      | M      | Schönmeier Michael     |         |
| GER      | M      | Staaf Robin            |         |
| GER      | M      | Steverding Michele     |         |
| GER      | M      | Walzer Anton           |         |
| GER      | M      | Wankmüller Janne-Rik   |         |

# Jugend Kata Jungen

Offene Landesmeisterschaft Hessen und Rheinland - Pfalz 2024, Schulstraße 2, 69509 Mörlenbach, GER

2024-02-03

Tatami  
5 10:00

Pool  
1/2

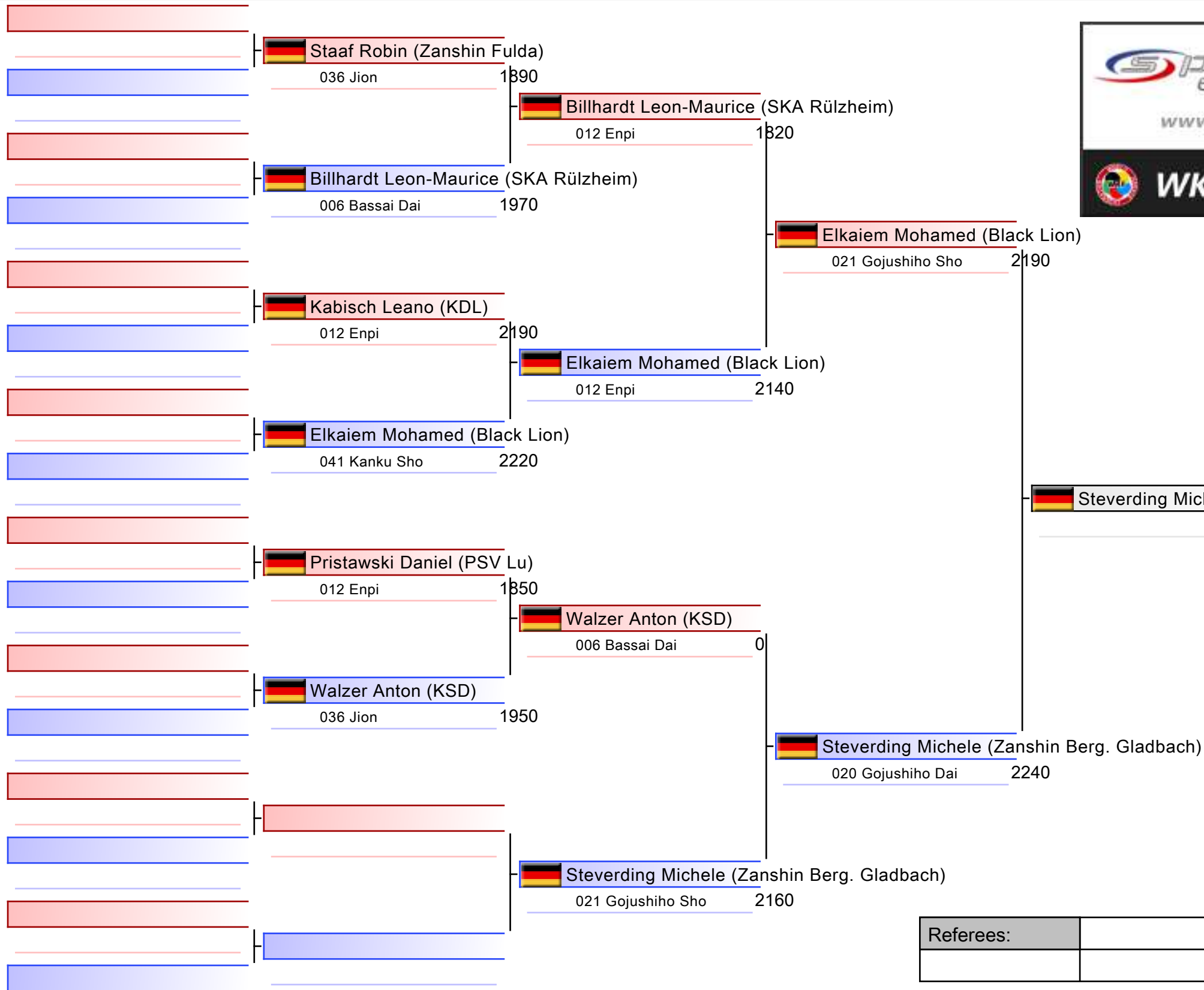

|  |
|--|
| 1. STEVERDING MICHELE (ZANSHIN BERG. GLADBACH) |
| 2. SCHÖNMEIER MICHAEL (ZANSHIN FULDA)          |
| 3. ELKAIEM MOHAMED (BLACK LION)                |
| 3. BIER PHILIP (TV HOLZ)                       |
| 5. WALZER ANTON (KSD)                          |
| 5. MÜNCH FABIO (SKA RÜLZHEIM)                  |
| 7. JAHN LEON NOEL (IGS BUDOKAN KL)             |

|           |  |  |  |
|-----------|--|--|--|
| Referees: |  |  |  |
|           |  |  |  |

# Jugend Kata Jungen

Offene Landesmeisterschaft Hessen und Rheinland - Pfalz 2024, Schulstraße 2, 69509 Mörlenbach, GER

2024-02-03

Tatami  
6 10:00

Pool  
2/2

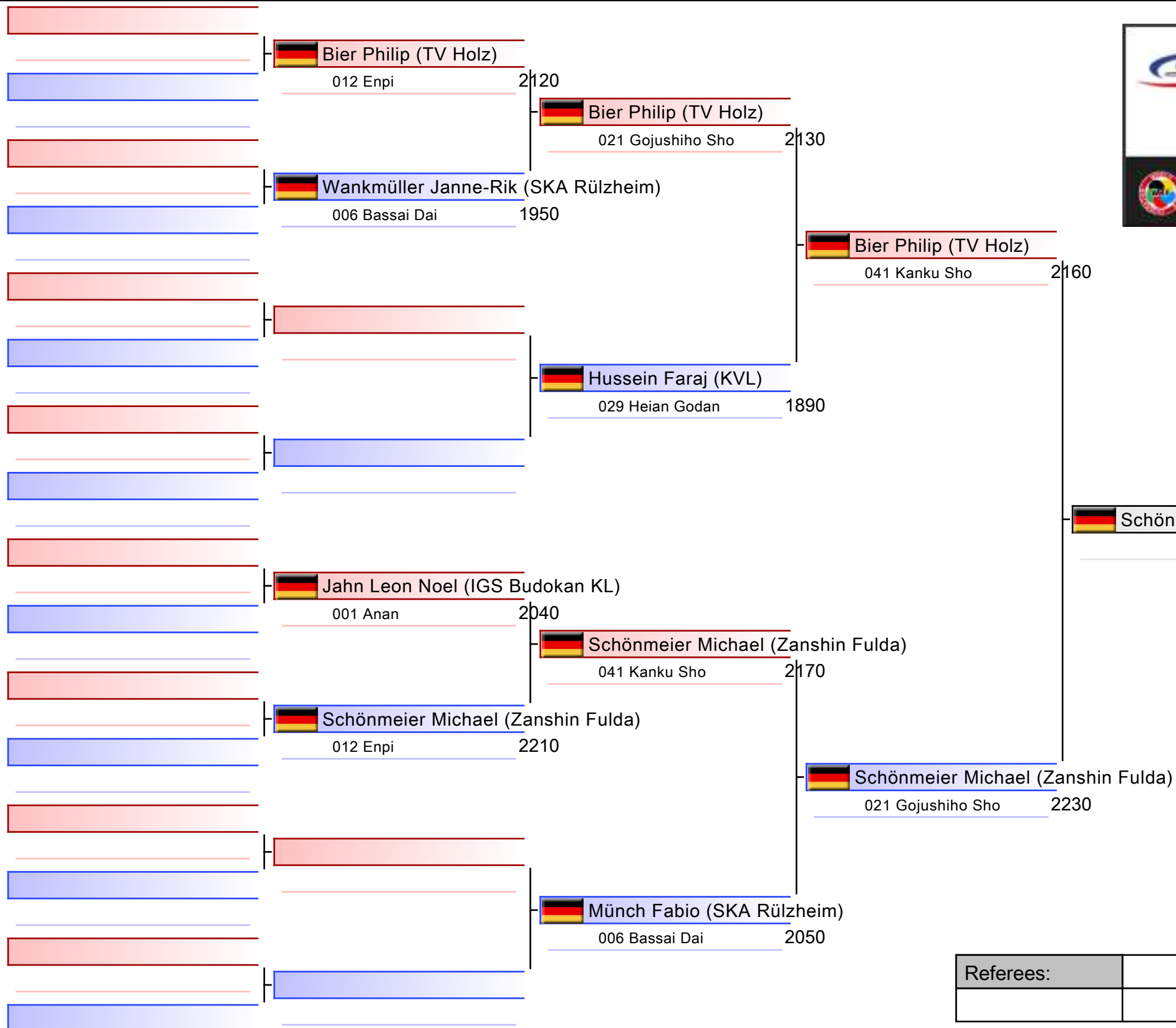

- |  |
|--|
| 1. STEVERDING MICHELE (ZANSHIN BERG. GLAD) |
| 2. SCHÖNMEIER MICHAEL (ZANSHIN FULDA)      |
| 3. ELKAIEM MOHAMED (BLACK LION)            |
| 3. BIER PHILIP (TV HOLZ)                   |
| 5. WALZER ANTON (KSD)                      |
| 5. MÜNCH FABIO (SKA RÜLZHEIM)              |
| 7. JAHN LEON NOEL (IGS BUDOKAN KL)         |

|           |  |  |  |
|-----------|--|--|--|
| Referees: |  |  |  |
|           |  |  |  |

# Poolieger-Jugend Kata Jungen

Offene Landesmeisterschaft Hessen und Rheinland - Pfalz 2024, Schulstraße 2, 69509 Mörlenbach, GER

Tatami

Pool

1/1

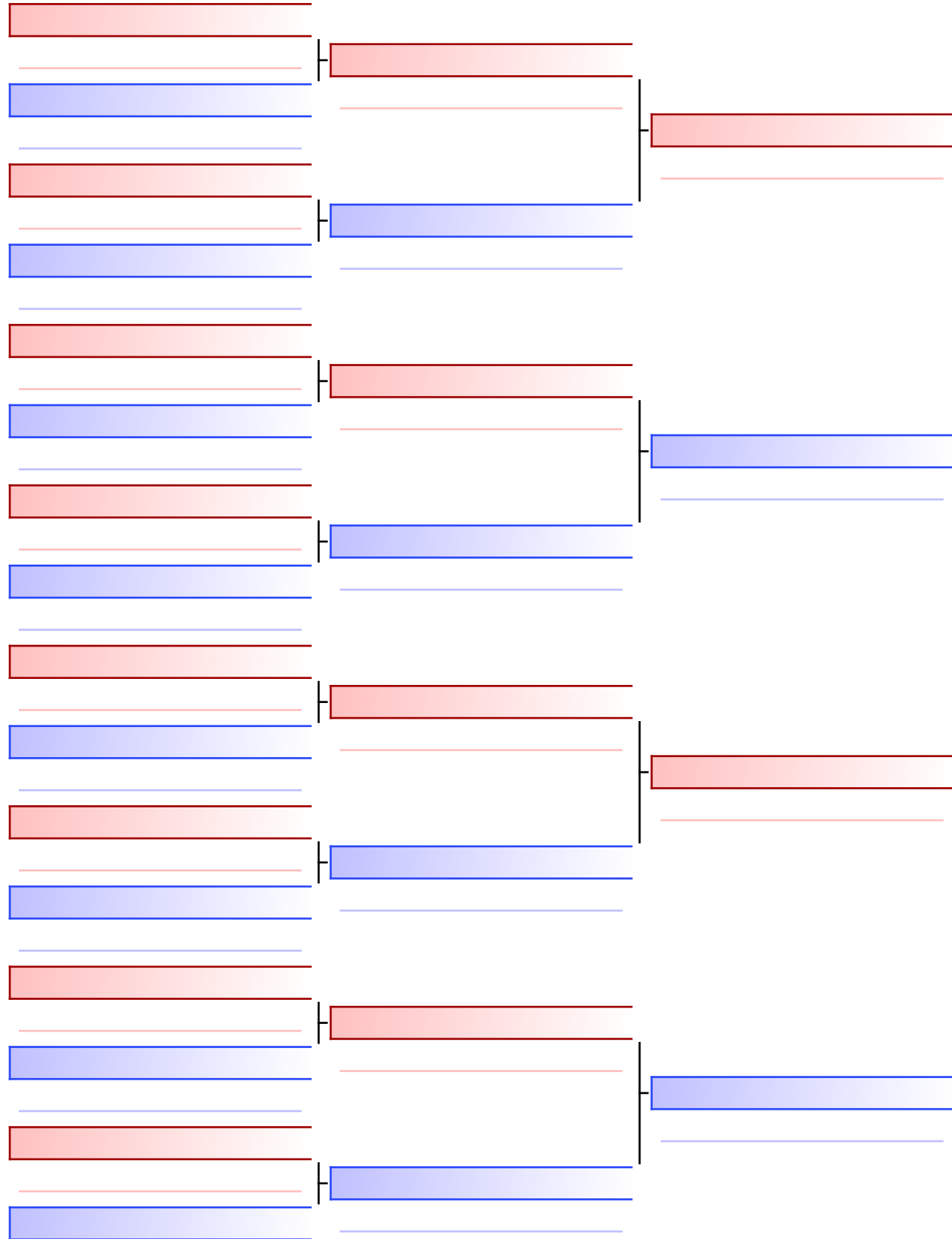

## Finale

Steverding Michele (Zanshin Berg. Gladbach)

041 Kanku Sho 3890

Steverding Michele (Zanshin Berg. Gladbach)

Schönmeier Michael (Zanshin Fulda)

099 Unsu 3780

- |  |
|--|
| 1. STEVERDING MICHELE (ZANSHIN BERG. GLADBACH) |
| 2. SCHÖNMEIER MICHAEL (ZANSHIN FULDA)          |
| 3. ELKAIEM MOHAMED (BLACK LION)                |
| 3. BIER PHILIP (TV HOLZ)                       |
| 5. WALZER ANTON (KSD)                          |
| 5. MÜNCH FABIO (SKA RÜLZHEIM)                  |
| 7. JAHN LEON NOEL (IGS BUDOKAN KL)             |

|           |  |  |  |
|-----------|--|--|--|
| Referees: |  |  |  |
|           |  |  |  |

# Jugend Kata Jungen

Offene Landesmeisterschaft Hessen und Rheinland - Pfalz 2024

2024-02-03

Tatami

5 10:35

Pool

1

(c)sportdata GmbH & Co KG 2000-2024 (2024-02-04 18:16) v 10.1.0 build 1 (2024-01-30 21:40 CET) Lizenz: Online\_Event\_ID-7816\_OffeneLandesmeisterschaftHessenundRheinlandPfalz2024 (expire 2024-02-18)

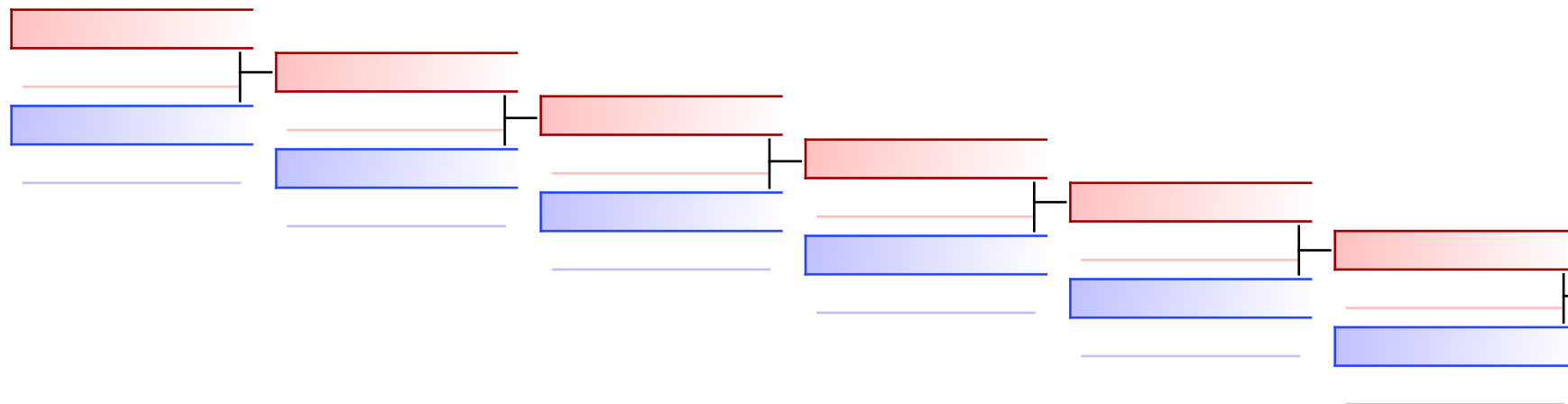

 Walzer Anton (KSD)  
029 Heian God. 3080

 Elkaiem Mohamed (Black Lion)

 Elkaiem Mohamed (Black Lion)  
020 Gojushiho. 3700

## TROSTRUNDE: (1)

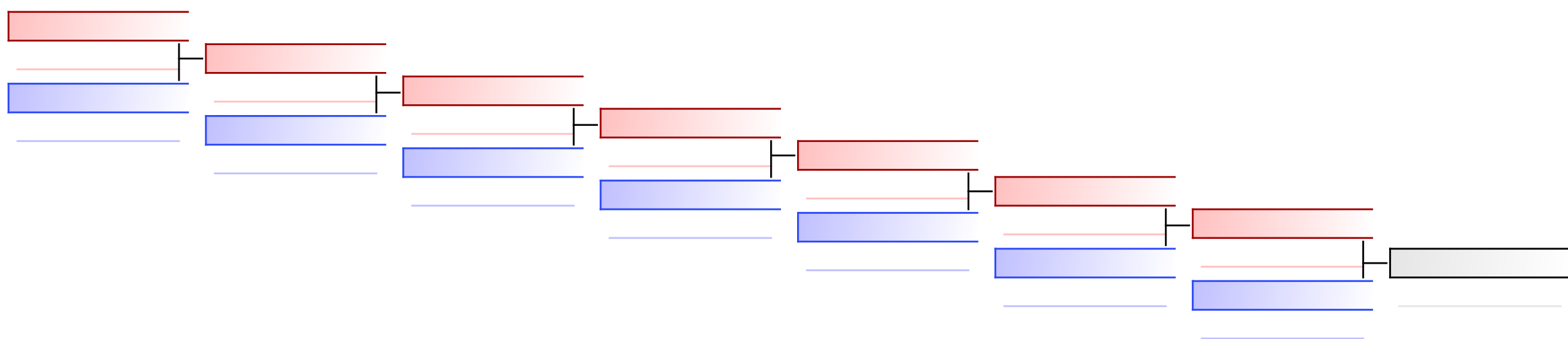

|           |  |  |  |  |  |  |  |
|-----------|--|--|--|--|--|--|--|
| Referees: |  |  |  |  |  |  |  |
|-----------|--|--|--|--|--|--|--|

# Jugend Kata Jungen

Offene Landesmeisterschaft Hessen und Rheinland - Pfalz 2024

2024-02-03

Tatami

5 10:50

Pool

2

(c)sportdata GmbH & Co KG 2000-2024 (2024-02-04 18:16) v 10.1.0 build 1 (2024-01-30 21:40 CET) Lizenz: Online\_Event\_ID-7816\_OffeneLandesmeisterschaftHessenundRheinlandPfalz2024 (expire 2024-02-18)

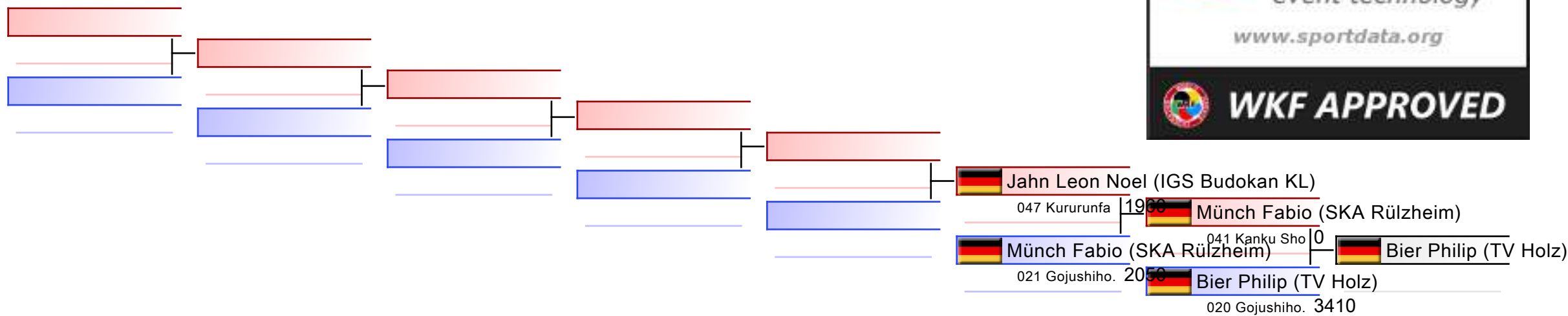

## TROSTRUNDE: (2)

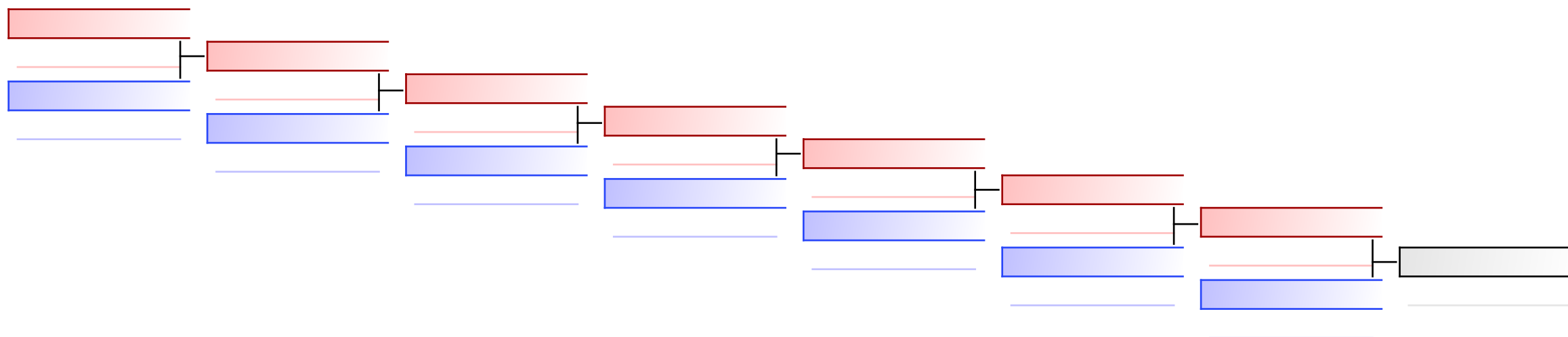

|           |  |  |  |  |  |  |  |
|-----------|--|--|--|--|--|--|--|
| Referees: |  |  |  |  |  |  |  |
|-----------|--|--|--|--|--|--|--|



Offene Landesmeisterschaft Hessen  
und Rheinland - Pfalz 2024 - 2024-02-03

Offizielle Ergebnisliste

| Jugend Kata Jungen |                    |   |  |               |
|--------------------|--------------------|---|--|---------------|
| 1                  | STEVERDING MICHELE | KARATE ZANSHIN<br>BERGISCH<br>GLADBACH E.V.       |  | GER - GERMANY |
| 2                  | SCHÖNMEIER MICHAEL | ZANSHIN GRÜN-<br>WEISS FULDA                      |  | GER - GERMANY |
| 3                  | ELKAIEM MOHAMED    | BLACK LION<br>SHOTOKAN KARATE<br>KÖLN E.V.        |  | GER - GERMANY |
| 3                  | BIER PHILIP        | TURNVEREIN HOLZ<br>02 E.V.                        |  | GER - GERMANY |
| 5                  | WALZER ANTON       | KARATE-SCHULE<br>DOKAN                            |  | GER - GERMANY |
| 5                  | MÜNCH FABIO        | SHOTOKAN<br>RYU KARATE<br>DO AKADEMIE<br>RÜLZHEIM |  | GER - GERMANY |
| 7                  | JAHN LEON NOEL     | IGS BUDOKAN<br>KAISERSLAUTERN                     |  | GER - GERMANY |

# JUGEND KATA MÄDCHEN





# Offene Landesmeisterschaft Hessen und Rheinland -..

## ENTRIES BY WEIGHT CATEGORY

### Jugend Kata Mädchen

As of 4 FEB 2024

| NOC Code | Gender | Name                   | Seeding |
|----------|--------|------------------------|---------|
| GER      | F      | Baghdjian Dana         |         |
| GER      | F      | Biedemann Greta        |         |
| GER      | F      | Biedemann Hannah       |         |
| GER      | F      | Cakmak Ela             |         |
| GER      | F      | Demirtas Momoka        |         |
| GER      | F      | Iskandaryan Anne-Marie |         |
| GER      | F      | Koch Sofia Catarina    |         |
| GER      | F      | Neuwirth Lara          |         |
| GER      | F      | Richter Lara           |         |
| GER      | F      | Sander Suvi-Lina       |         |
| GER      | F      | Stroh Venera           |         |
| GER      | F      | Wienbeck Rani          |         |

# Jugend Kata Mädchen

Offene Landesmeisterschaft Hessen und Rheinland - Pfalz 2024, Schulstraße 2, 69509 Mörlenbach, GER

2024-02-03

Tatami  
4 09:40

Pool  
1/1

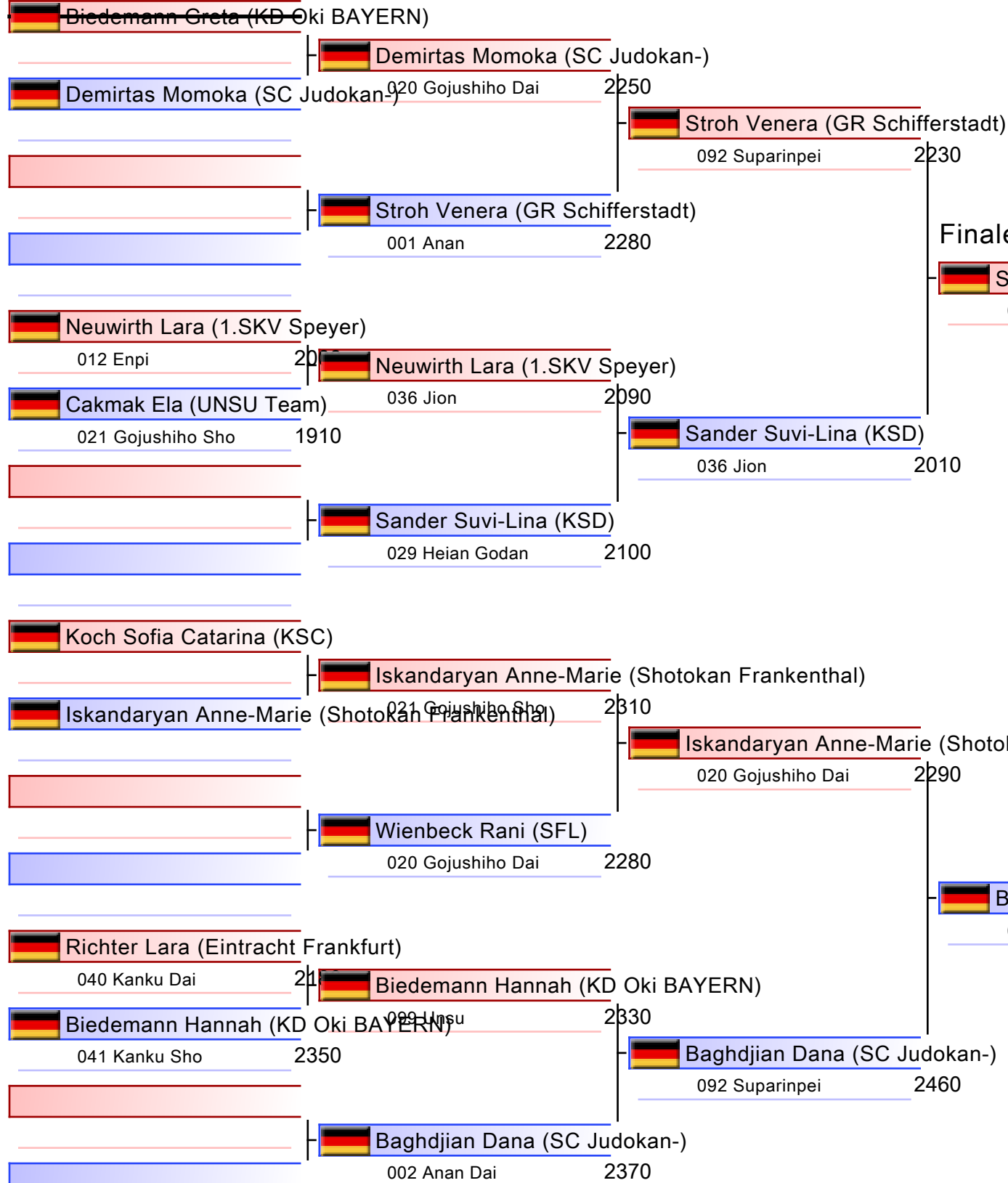

|  |
|--|
| 1. BAGHDJIAN DANA (SC JUDOKAN-)                  |
| 2. STROH VENERA (GR SCHIFFERSTADT)               |
| 3. DEMIRTAS MOMOKA (SC JUDOKAN-)                 |
| 3. ISKANDARYAN ANNE-MARIE (SHOTOKAN FRANKENTHAL) |
| 5. SANDER SUVI-LINA (KSD)                        |
| 5. BIEDEMANN HANNAH (KD OKI BAYERN)              |
|  |
|  |

|           |  |  |  |
|-----------|--|--|--|
| Referees: |  |  |  |
|           |  |  |  |

# Jugend Kata Mädchen

Offene Landesmeisterschaft Hessen und Rheinland - Pfalz 2024

2024-02-03

Tatami  
4 10:40

Pool  
1

(c)sportdata GmbH & Co KG 2000-2024 (2024-02-04 18:16) v 10.1.0 build 1 (2024-01-30 21:40 CET) Lizenz: Online\_Event\_ID-7816\_OffeneLandesmeisterschaftHessenundRheinlandPfalz2024 (expire 2024-02-18)

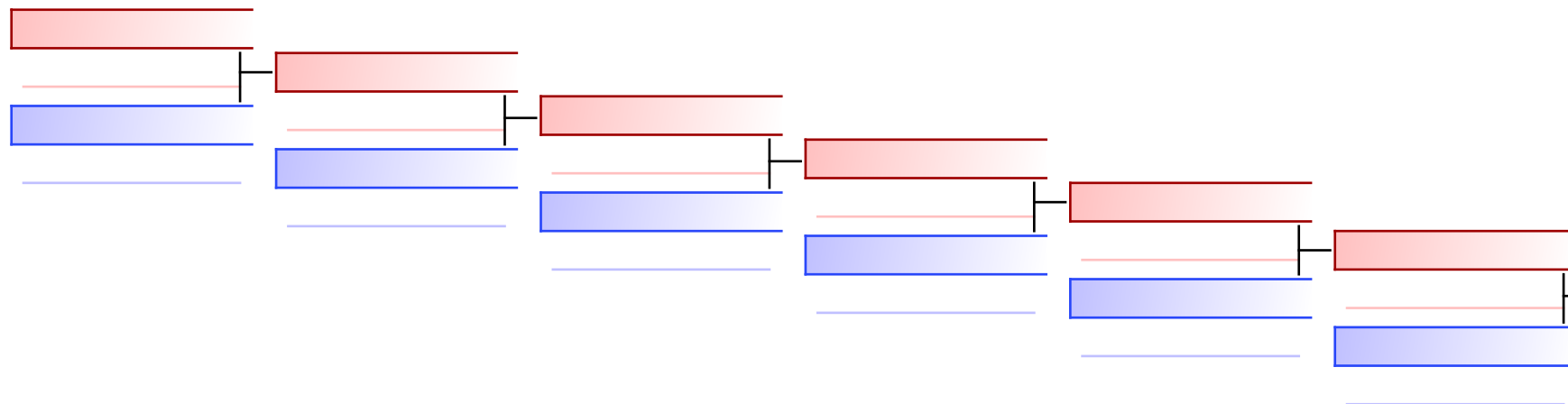

Demirtas Momoka (SC Judokan-)  
021 Gojushiho. 2230

Sander Suvi-Lina (KSD)  
006 Bassai Da. 2050

## TROSTRUNDE: (1)

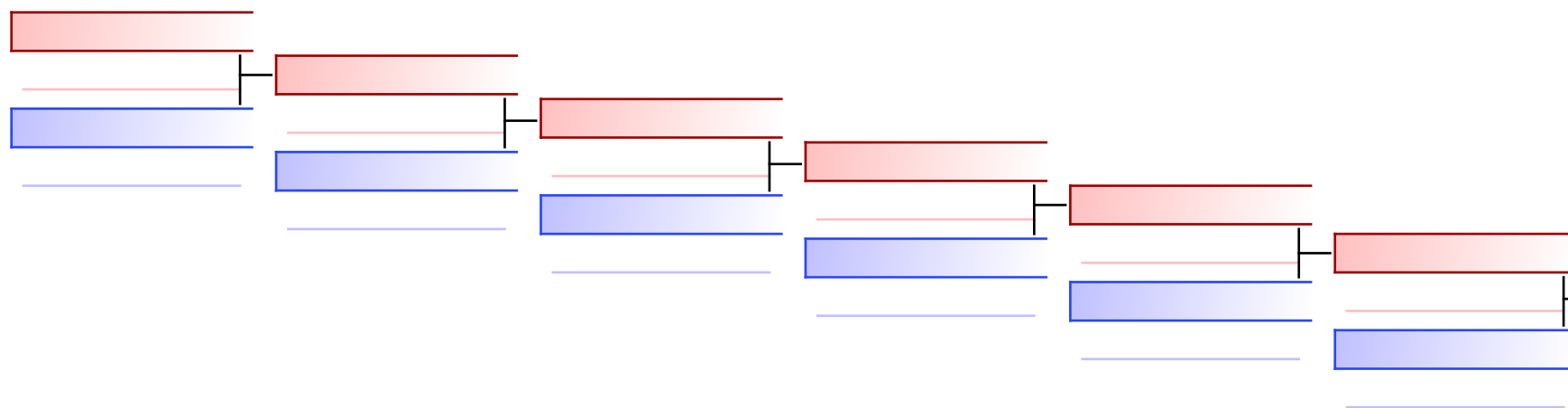

Biedemann Hannah (KD Oki BAYERN)  
015 Gankaku 2240

Iskandaryan Anne-Marie (Shotokan Frankenthal)  
099 Unsu 2380

|           |  |  |  |  |  |  |  |
|-----------|--|--|--|--|--|--|--|
| Referees: |  |  |  |  |  |  |  |
|-----------|--|--|--|--|--|--|--|



Offene Landesmeisterschaft Hessen  
und Rheinland - Pfalz 2024 - 2024-02-03

Offizielle Ergebnisliste

| Jugend Kata Mädchen |                        |  |  |               |
|---------------------|------------------------|--|--|---------------|
| 1                   | BAGHDJIAN DANA         | SC JUDOKAN E.V.                                |  | GER - GERMANY |
| 2                   | STROH VENERA           | GOJU-RYU<br>KARATEVEREIN<br>SCHIFFERSTADT E.V. |  | GER - GERMANY |
| 3                   | DEMIRTAS MOMOKA        | SC JUDOKAN E.V.                                |  | GER - GERMANY |
| 3                   | ISKANDARYAN ANNE-MARIE | 1. SHOTOKAN<br>KARATE CLUB<br>FRANKENTHAL E.V. |  | GER - GERMANY |
| 5                   | SANDER SUVI-LINA       | KARATE-SCHULE<br>DOKAN                         |  | GER - GERMANY |
| 5                   | BIEDEMANN HANNAH       | KARATE DOJO OKI<br>BAYERN                      |  | GER - GERMANY |

# JUGEND KUMITE JUNGEN +70 KG



# Offene Landesmeisterschaft Hessen und Rheinland -..

## ENTRIES BY WEIGHT CATEGORY

### Jugend Kumite Jungen +70 kg

As of 4 FEB 2024

| NOC Code | Gender | Name              | Seeding |
|----------|--------|-------------------|---------|
| GER      | M      | Ambrosius Elias   |         |
| GER      | M      | Ay Mirhat         |         |
| GER      | M      | Breisch Sebastian |         |
| GER      | M      | Fatsis Konstantin |         |
| GER      | M      | Grüner Mika       |         |
| GER      | M      | Hussein Faraj     |         |

# Jugend Kumite Jungen +70 kg

Offene Landesmeisterschaft Hessen und Rheinland - Pfalz 2024, Schulstraße 2, 69509 Mörlenbach, GER

2024-02-03

Tatami  
1 13:45

Pool  
1/1

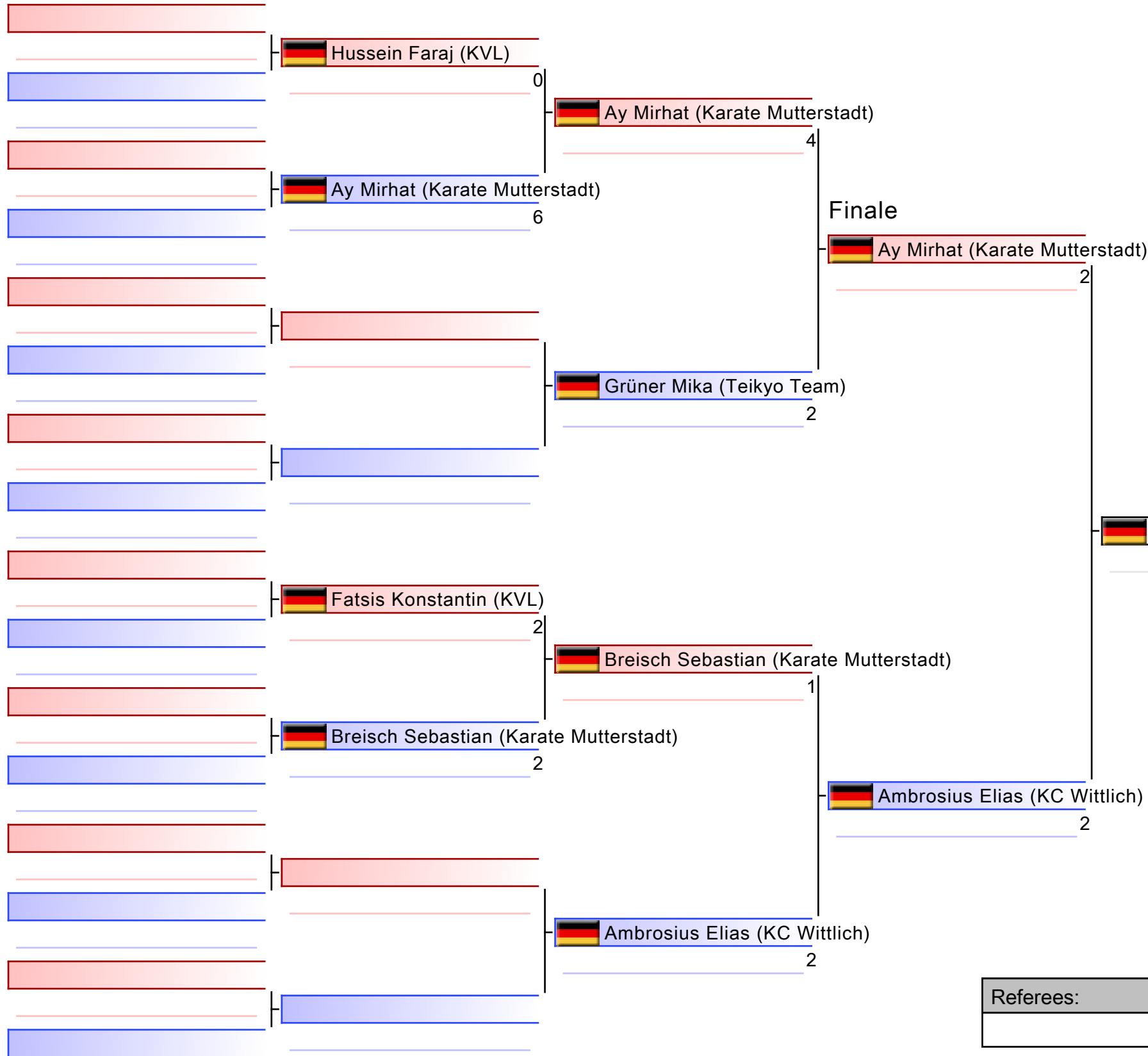

|   |
|---|
| 1. AMBROSIUS ELIAS (KC WITTLICH)          |
| 2. AY MIRHAT (KARATE MUTTERSTADT)         |
| 3. BREISCH SEBASTIAN (KARATE MUTTERSTADT) |
| 3. GRÜNER MIKA (TEIKYO TEAM)              |
| 5. HUSSEIN FARAJ (KVL)                    |
|   |
|   |

|           |  |  |  |
|-----------|--|--|--|
| Referees: |  |  |  |
|           |  |  |  |

# Jugend Kumite Jungen +70 kg

Offene Landesmeisterschaft Hessen und Rheinland - Pfalz 2024

2024-02-03

Tatami  
1 14:05

Pool  
1

(c)sportdata GmbH & Co KG 2000-2024 (2024-02-04 18:16) v 10.1.0 build 1 (2024-01-30 21:40 CET) Lizenz: Online\_Event\_ID-7816\_OffeneLandesmeisterschaftHessenundRheinlandPfalz2024 (expire 2024-02-18)

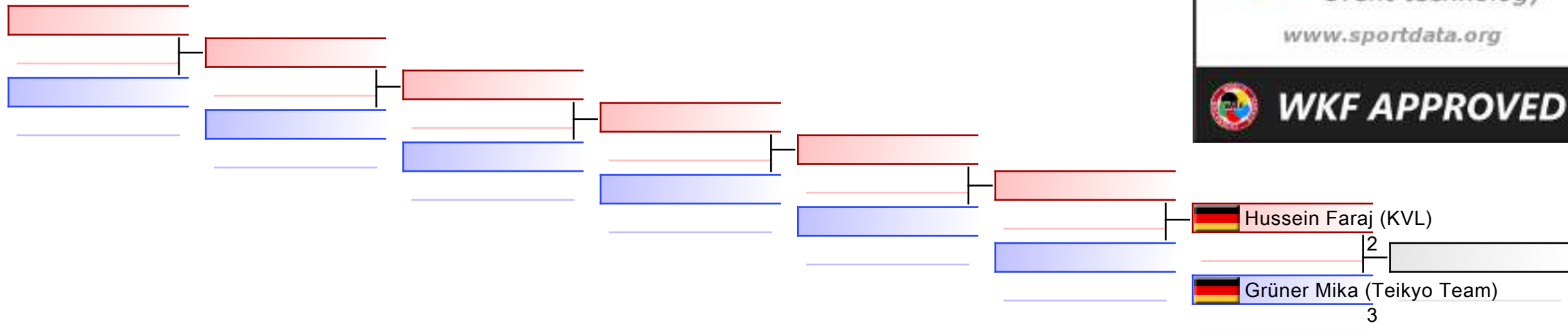

## TROSTRUNDE: (1)

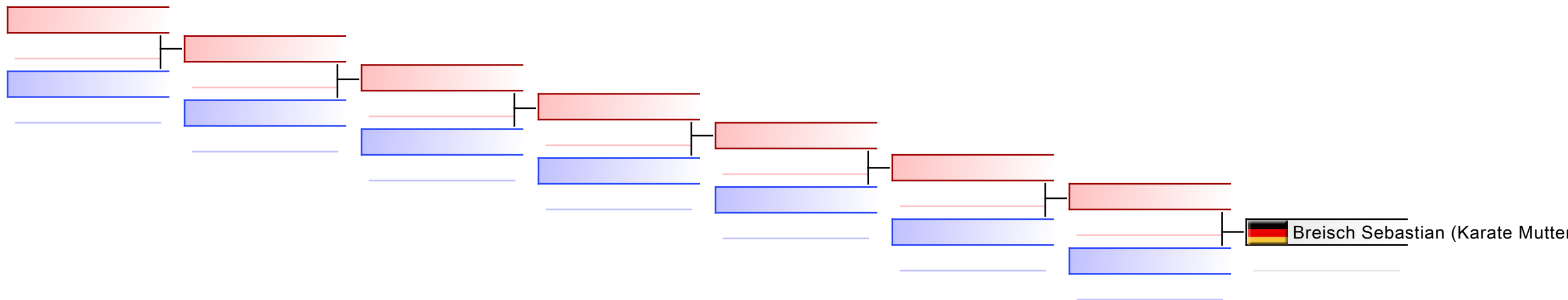

|           |  |  |  |  |  |  |  |
|-----------|--|--|--|--|--|--|--|
| Referees: |  |  |  |  |  |  |  |
|-----------|--|--|--|--|--|--|--|





Offene Landesmeisterschaft Hessen  
und Rheinland - Pfalz 2024 - 2024-02-03

Offizielle Ergebnisliste

| Jugend Kumite Jungen +70 kg |                   |                              |   |               |
|-----------------------------|-------------------|------------------------------|---|---------------|
| 1                           | AMBROSIUS ELIAS   | KARATE CLUB<br>WITTLICH      |  | GER - GERMANY |
| 2                           | AY MIRHAT         | KARATE<br>MUTTERSTADT        |  | GER - GERMANY |
| 3                           | BREISCH SEBASTIAN | KARATE<br>MUTTERSTADT        |  | GER - GERMANY |
| 3                           | GRÜNER MIKA       | TEIKYO KARATE<br>TEAM E.V.   |  | GER - GERMANY |
| 5                           | HUSSEIN FARAJ     | KARATE-VEREIN<br>LANGEN E.V. |  | GER - GERMANY |

# JUGEND KUMITE JUNGEN -52 KG



# Offene Landesmeisterschaft Hessen und Rheinland -..

## ENTRIES BY WEIGHT CATEGORY

### Jugend Kumite Jungen -52 kg

As of 4 FEB 2024

| NOC Code | Gender | Name              | Seeding |
|----------|--------|-------------------|---------|
| GER      | M      | Becker Yannik     |         |
| GER      | M      | Chnykin Kiril     |         |
| GER      | M      | Guidouche Yacoub  |         |
| GER      | M      | Mezhlumova David  |         |
| GER      | M      | Ruhmann Max       |         |
| GER      | M      | Swidersky Ben     |         |
| GER      | M      | Tschumarow Andrej |         |
| GER      | M      | Ueberfeld Fabian  |         |

# Jugend Kumite Jungen -52 kg

Offene Landesmeisterschaft Hessen und Rheinland - Pfalz 2024, Schulstraße 2, 69509 Mörlenbach, GER

2024-02-03

Tatami  
2 13:45

Pool  
1/1

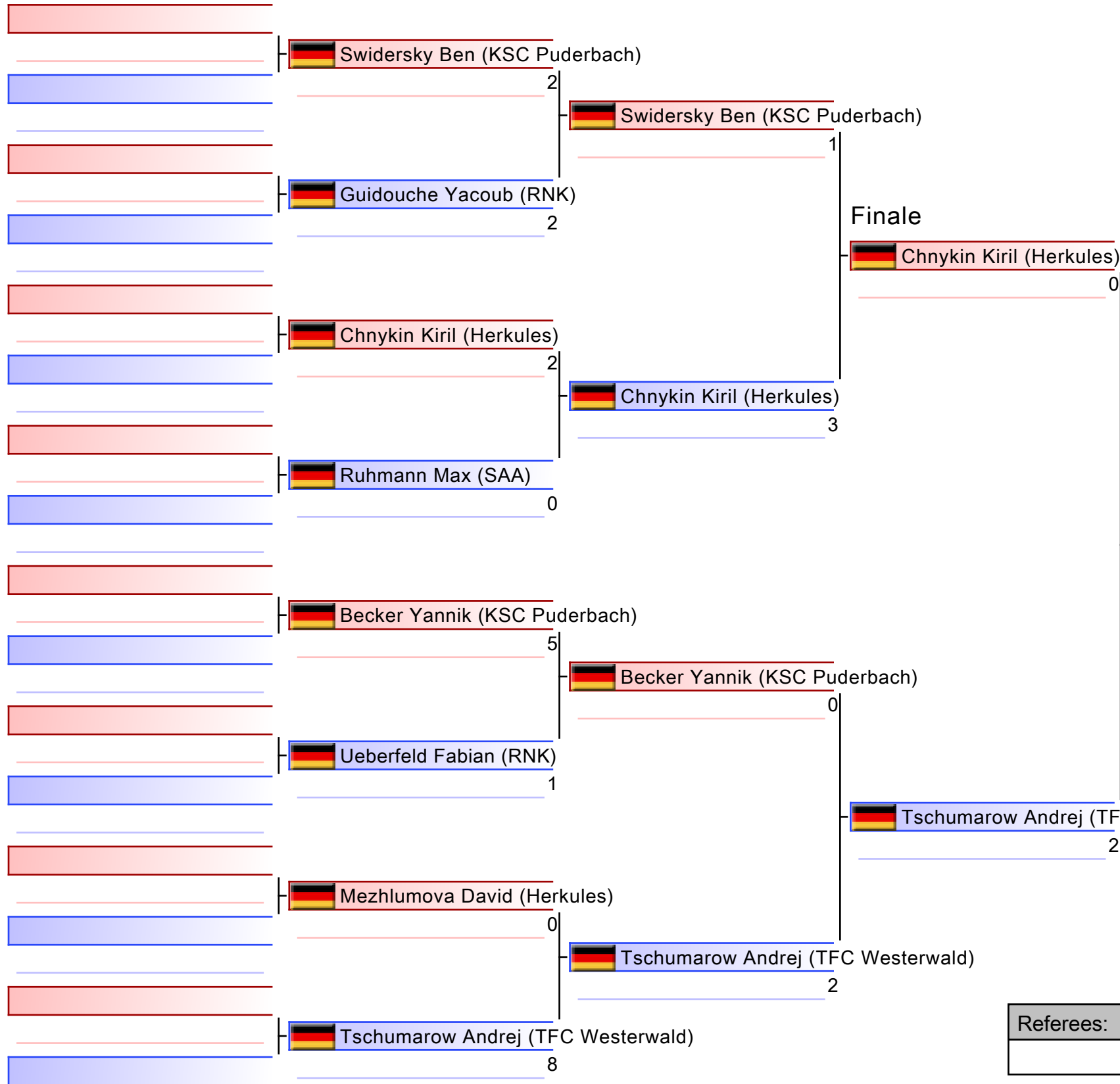

|                                       |
|---------------------------------------|
| 1. TSCHUMAROW ANDREJ (TFC WESTERWALD) |
| 2. CHNYKIN KIRIL (HERKULES)           |
| 3. RUHMANN MAX (SAA)                  |
| 3. BECKER YANNIK (KSC PUDERBACH)      |
| 5. SWIDERSKY BEN (KSC PUDERBACH)      |
| 5. MEZHLUMOVA DAVID (HERKULES)        |
|                                       |
|                                       |

|           |  |  |  |
|-----------|--|--|--|
| Referees: |  |  |  |
|           |  |  |  |

# Jugend Kumite Jungen -52 kg

Offene Landesmeisterschaft Hessen und Rheinland - Pfalz 2024

2024-02-03

Tatami

2 14:15

Pool

1

(c)sportdata GmbH & Co KG 2000-2024 (2024-02-04 18:16) v 10.1.0 build 1 (2024-01-30 21:40 CET) Lizenz: Online\_Event\_ID-7816\_OffeneLandesmeisterschaftHessenundRheinlandPfalz2024 (expire 2024-02-18)

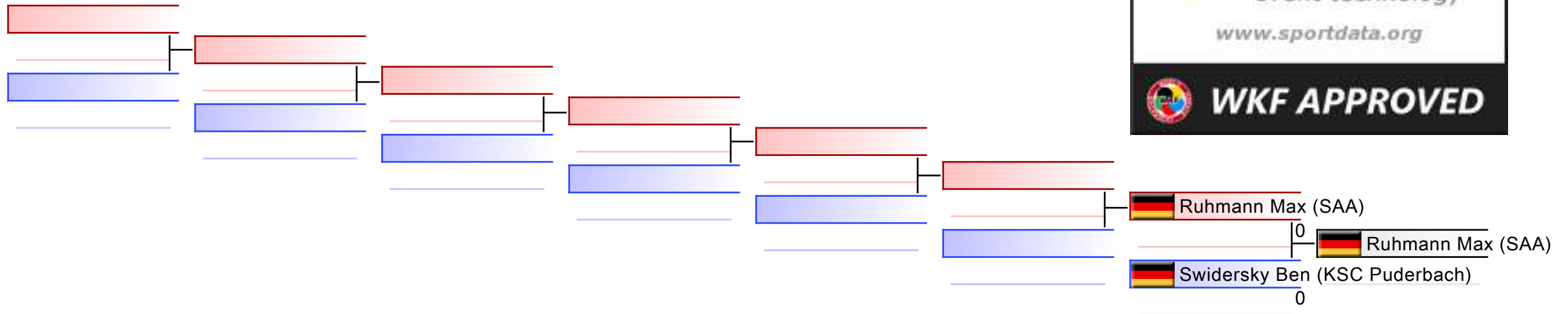

## TROSTRUNDE: (1)

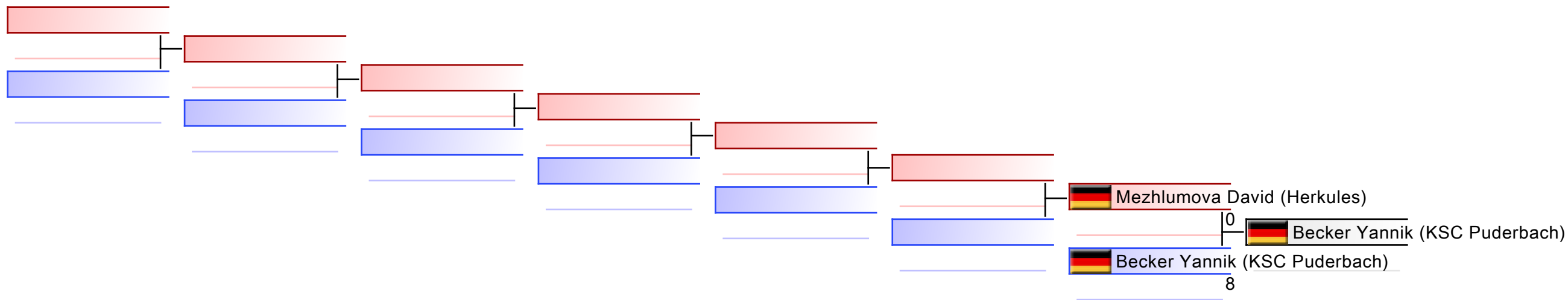

|           |  |  |  |  |  |  |  |
|-----------|--|--|--|--|--|--|--|
| Referees: |  |  |  |  |  |  |  |
|-----------|--|--|--|--|--|--|--|



Offene Landesmeisterschaft Hessen  
und Rheinland - Pfalz 2024 - 2024-02-03

Offizielle Ergebnisliste

| Jugend Kumite Jungen -52 kg |                   |   |   |               |
|-----------------------------|-------------------|---|---|---------------|
| 1                           | TSCHUMAROW ANDREJ | TEAM FIGHTCLUB<br>WESTERWALD              |  | GER - GERMANY |
| 2                           | CHNYKIN KIRIL     | SV HERKULES 01<br>KASSEL E.V.             |  | GER - GERMANY |
| 3                           | RUHMANN MAX       | SAARLÄNDISCHER<br>KARATE- VERBAND<br>E.V. |  | GER - GERMANY |
| 3                           | BECKER YANNIK     | KARATE TEAM KSC<br>PUDERBACH              |  | GER - GERMANY |
| 5                           | SWIDERSKY BEN     | KARATE TEAM KSC<br>PUDERBACH              |  | GER - GERMANY |
| 5                           | MEZHLUMOVA DAVID  | SV HERKULES 01<br>KASSEL E.V.             |  | GER - GERMANY |

# JUGEND KUMITE JUNGEN -57 KG



# Offene Landesmeisterschaft Hessen und Rheinland -..

## ENTRIES BY WEIGHT CATEGORY

Jugend Kumite Jungen -57 kg

As of 4 FEB 2024

| NOC Code | Gender | Name            | Seeding |
|----------|--------|-----------------|---------|
| GER      | M      | Becker Finley   |         |
| GER      | M      | Hackel Fynn     |         |
| GER      | M      | Lubenets Daniel |         |
| GER      | M      | Stach Daniel    |         |



# Jugend Kumite Jungen -57 kg

Offene Landesmeisterschaft Hessen und Rheinland - Pfalz 2024, Schulstraße 2, 69509 Mörlenbach, GER

2024-02-03

Tatami  
1 14:15

Pool  
1/1

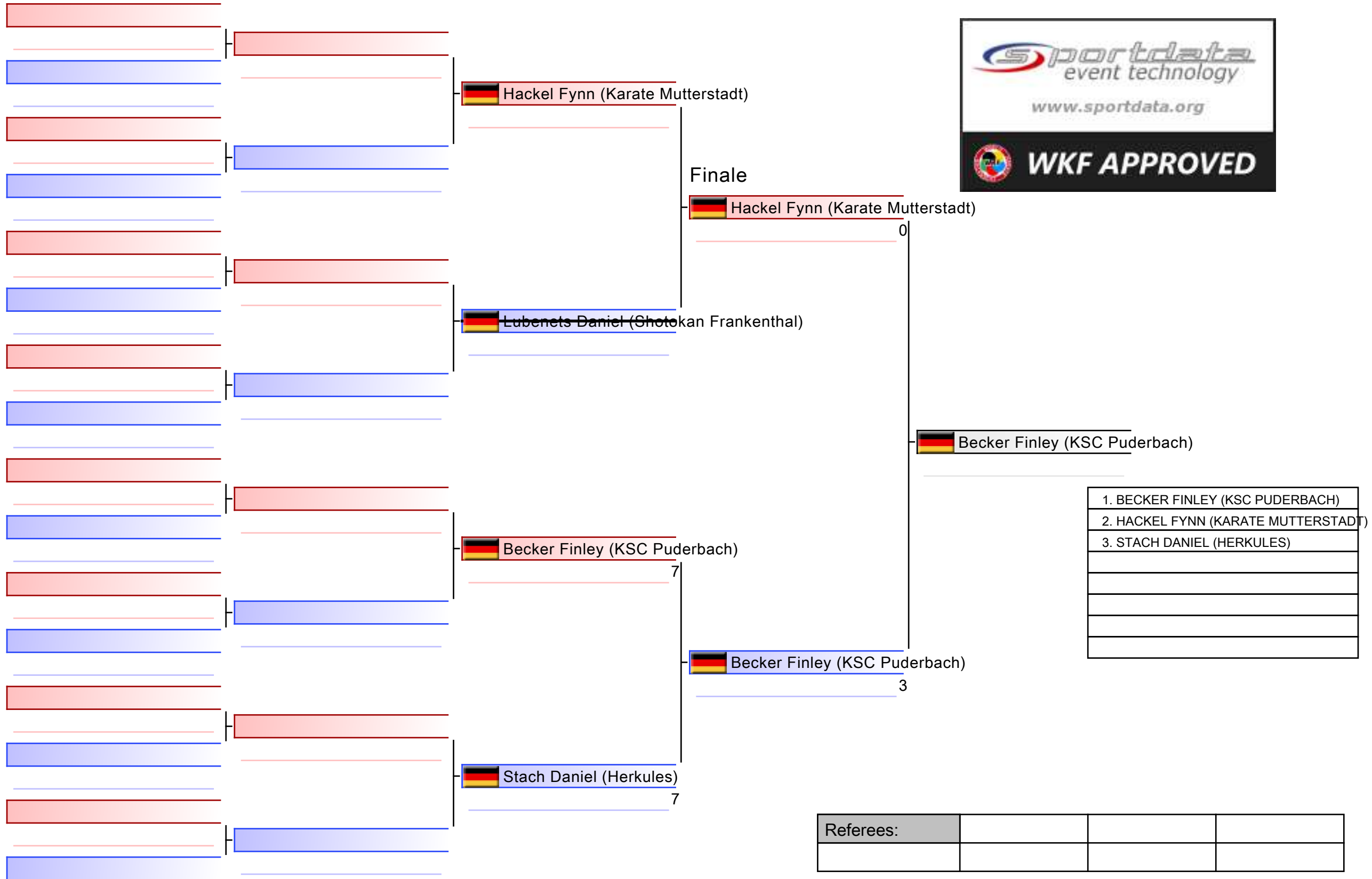

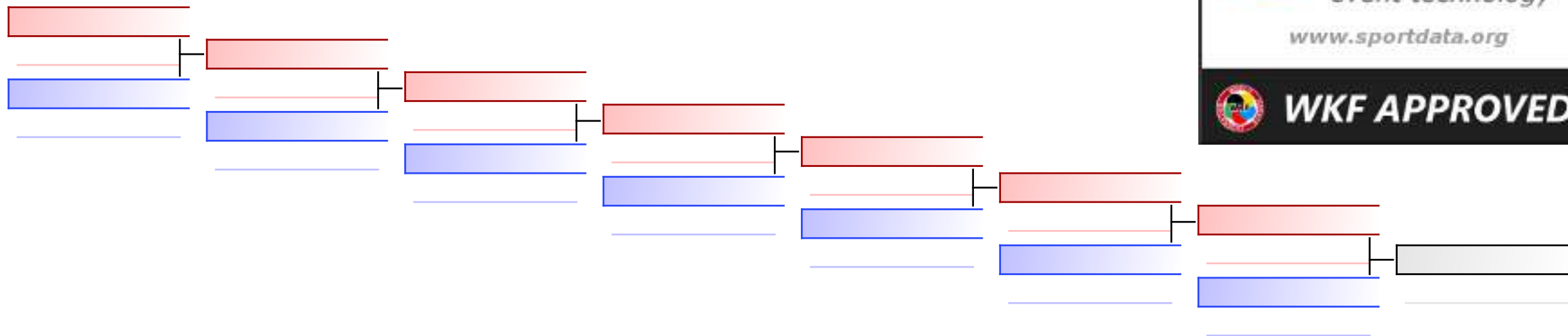

TROSTRUNDE: (1)

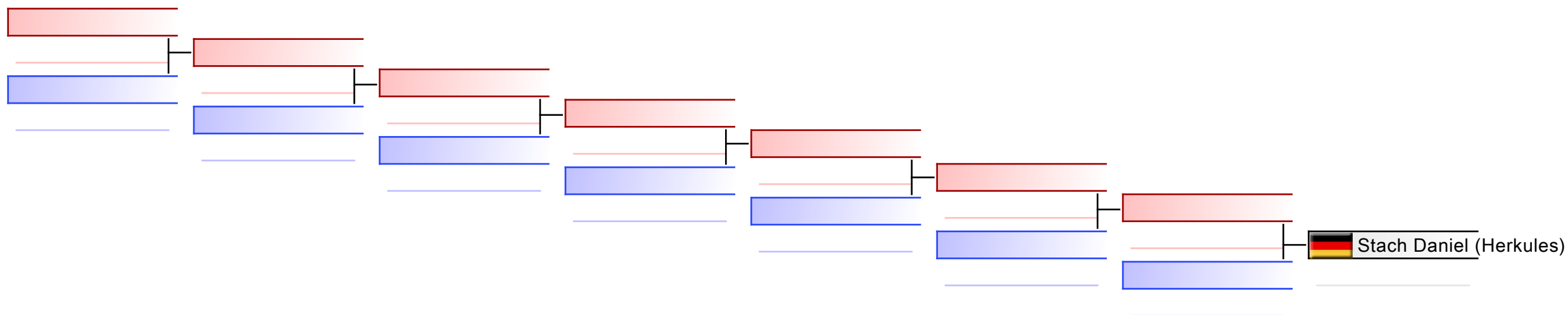



|           |  |  |  |  |  |  |  |
|-----------|--|--|--|--|--|--|--|
| Referees: |  |  |  |  |  |  |  |
|-----------|--|--|--|--|--|--|--|



Offene Landesmeisterschaft Hessen  
und Rheinland - Pfalz 2024 - 2024-02-03

Offizielle Ergebnisliste

| Jugend Kumite Jungen -57 kg |               |                               |   |               |
|-----------------------------|---------------|-------------------------------|---|---------------|
| 1                           | BECKER FINLEY | KARATE TEAM KSC<br>PUDERBACH  |  | GER - GERMANY |
| 2                           | HACKEL FYNN   | KARATE<br>MUTTERSTADT         |  | GER - GERMANY |
| 3                           | STACH DANIEL  | SV HERKULES 01<br>KASSEL E.V. |  | GER - GERMANY |



# JUGEND KUMITE JUNGEN -63 KG



# Offene Landesmeisterschaft Hessen und Rheinland -..

## ENTRIES BY WEIGHT CATEGORY

### Jugend Kumite Jungen -63 kg

As of 4 FEB 2024

| NOC Code | Gender | Name             | Seeding |
|----------|--------|------------------|---------|
| GER      | M      | Kurz Phil        |         |
| GER      | M      | Niederelz Tim    |         |
| GER      | M      | Serban Rares     |         |
| GER      | M      | Spoehr Tom Angus |         |

# Jugend Kumite Jungen -63 kg

Offene Landesmeisterschaft Hessen und Rheinland - Pfalz 2024, Schulstraße 2, 69509 Mörlenbach, GER

2024-02-03

Tatami  
1 14:25

Pool  
1/1

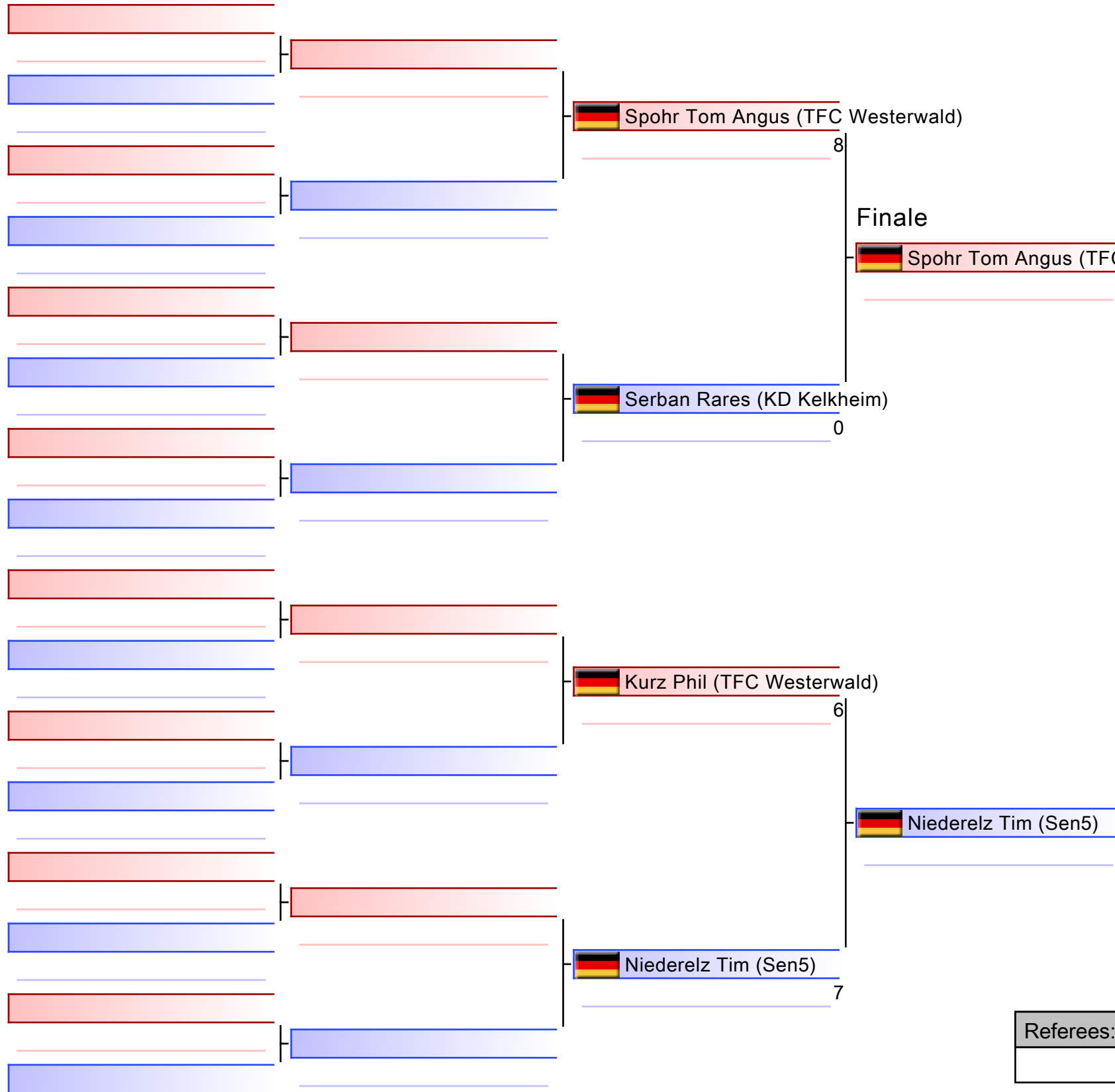

|                                     |
|-------------------------------------|
| 1. NIEDERELZ TIM (SEN5)             |
| 2. SPOHR TOM ANGUS (TFC WESTERWALD) |
| 3. SERBAN RARES (KD KELKHEIM)       |
| 3. KURZ PHIL (TFC WESTERWALD)       |
|                                     |
|                                     |
|                                     |

|           |  |  |  |
|-----------|--|--|--|
| Referees: |  |  |  |
|           |  |  |  |

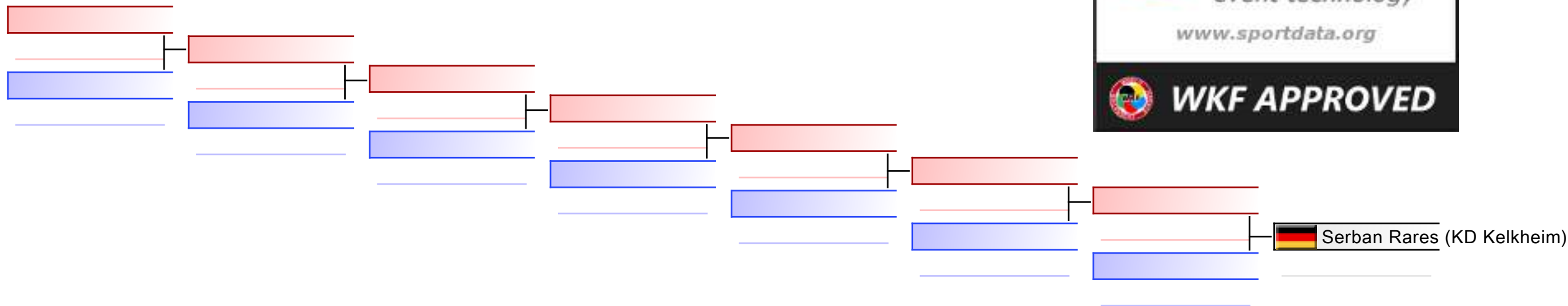

TROSTRUNDE: (1)

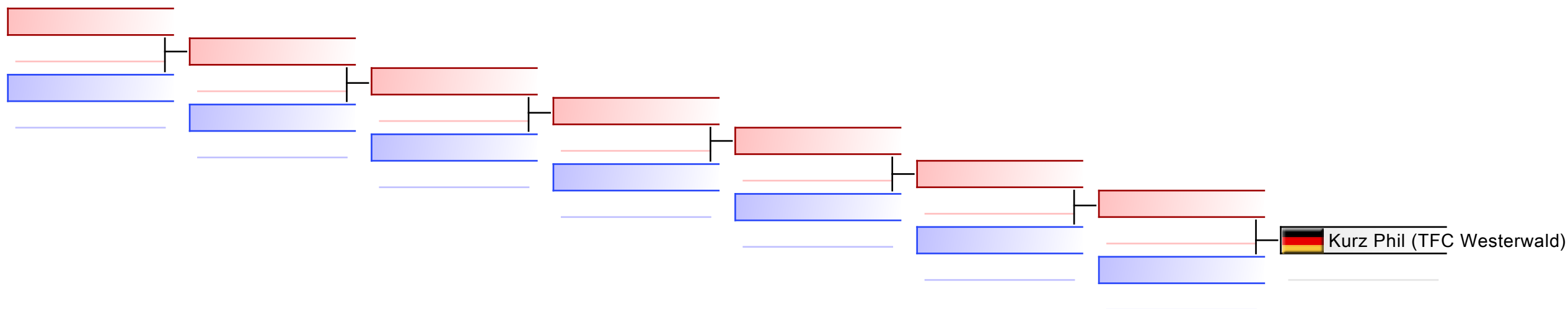

|           |  |  |  |  |  |  |  |
|-----------|--|--|--|--|--|--|--|
| Referees: |  |  |  |  |  |  |  |
|-----------|--|--|--|--|--|--|--|



Offene Landesmeisterschaft Hessen  
und Rheinland - Pfalz 2024 - 2024-02-03

Offizielle Ergebnisliste

| Jugend Kumite Jungen -63 kg |                 |                              |   |               |
|-----------------------------|-----------------|------------------------------|---|---------------|
| 1                           | NIEDERELZ TIM   | SEN5 KARATE<br>VEREIN E.V.   |  | GER - GERMANY |
| 2                           | SPOHR TOM ANGUS | TEAM FIGHTCLUB<br>WESTERWALD |  | GER - GERMANY |
| 3                           | SERBAN RARES    | KARATE-DOJO<br>KELKHEIM E.V. |  | GER - GERMANY |
| 3                           | KURZ PHIL       | TEAM FIGHTCLUB<br>WESTERWALD |  | GER - GERMANY |





# JUGEND KUMITE MÄDCHEN +61 K



# Offene Landesmeisterschaft Hessen und Rheinland -..

## ENTRIES BY WEIGHT CATEGORY

### Jugend Kumite Mädchen +61 kg

As of 4 FEB 2024

| NOC Code | Gender | Name              | Seeding |
|----------|--------|-------------------|---------|
| GER      | F      | Schindler Miley   |         |
| GER      | F      | Theobald Mia      |         |
| GER      | F      | Weißemeyer Emilia |         |

# Jugend Kumite Mädchen +61 kg

Offene Landesmeisterschaft Hessen und Rheinland - Pfalz 2024, Schulstraße 2, 69509 Mörlenbach, GER

2024-02-03

Tatami  
4 14:10

Pool  
1/1

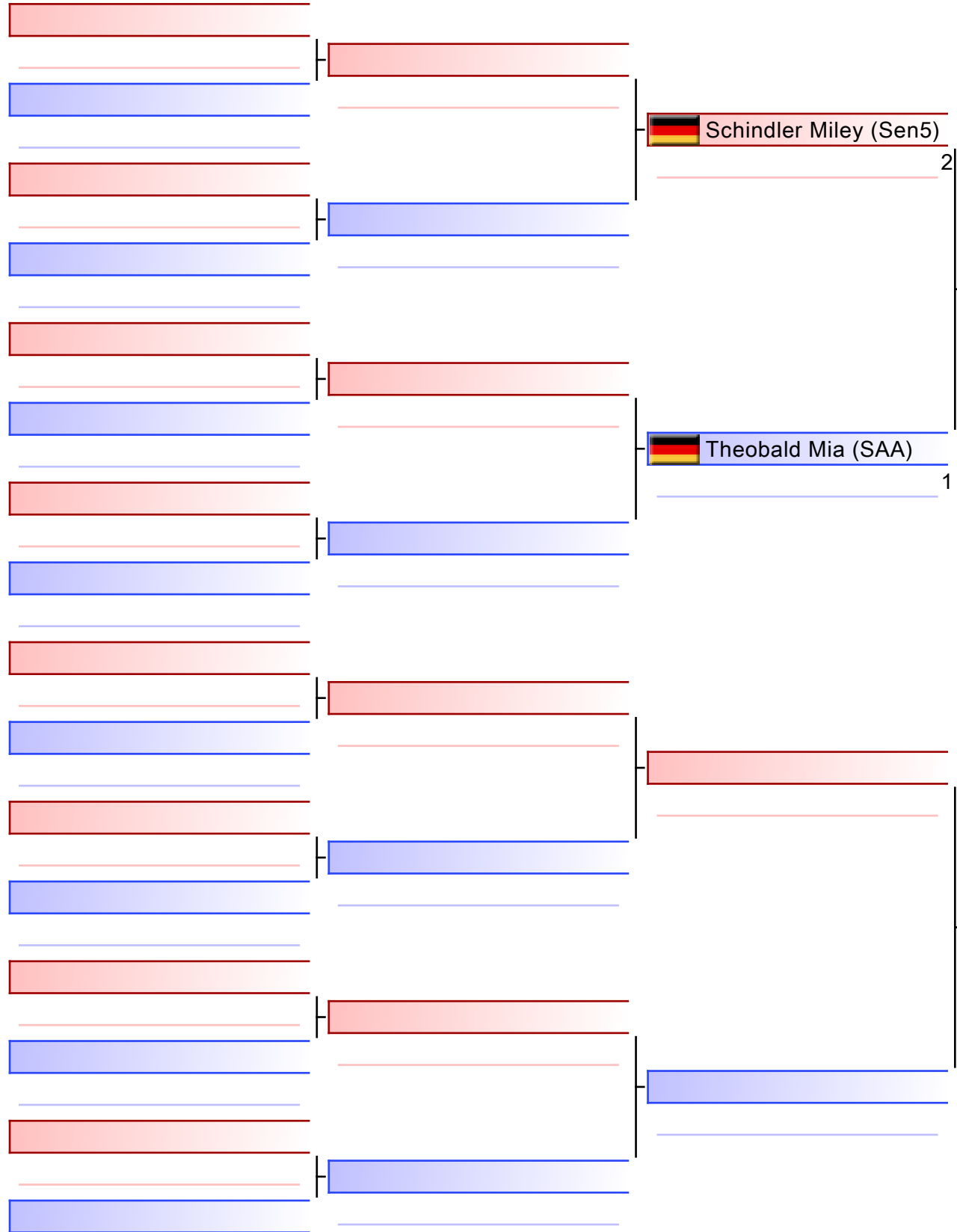

Finale

Schindler Miley (Sen5)

8

Theobald Mia (SAA)

1

Schindler Miley (Sen5)

Weißenmeyer Emilia (GR Schifferstadt)

0

|   |
|---|
| 1. SCHINDLER MILEY (SEN5)                 |
| 2. WEISSENMEYER EMILIA (GR SCHIFFERSTADT) |
| 3. THEOBALD MIA (SAA)                     |
|   |
|   |
|   |
|   |

|           |  |  |  |
|-----------|--|--|--|
| Referees: |  |  |  |
|           |  |  |  |

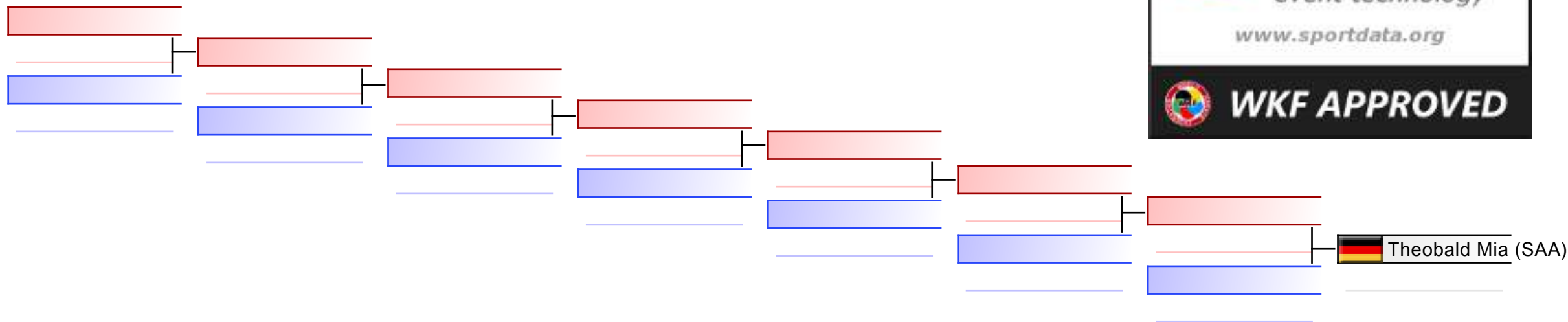

TROSTRUNDE: (1)

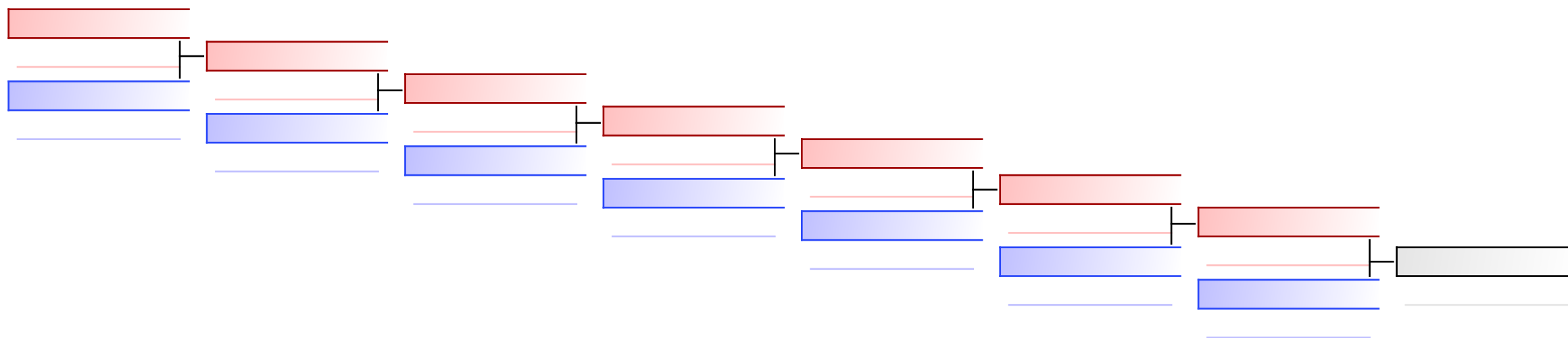

|           |  |  |  |  |  |  |  |
|-----------|--|--|--|--|--|--|--|
| Referees: |  |  |  |  |  |  |  |
|-----------|--|--|--|--|--|--|--|



Offene Landesmeisterschaft Hessen  
und Rheinland - Pfalz 2024 - 2024-02-03

Offizielle Ergebnisliste

| Jugend Kumite Mädchen +61 kg |                     |  |   |               |
|------------------------------|---------------------|--|---|---------------|
| 1                            | SCHINDLER MILEY     | SEN5 KARATE<br>VEREIN E.V.                     |  | GER - GERMANY |
| 2                            | WEISSENMEYER EMILIA | GOJU-RYU<br>KARATEVEREIN<br>SCHIFFERSTADT E.V. |  | GER - GERMANY |
| 3                            | THEOBALD MIA        | SAARLÄNDISCHER<br>KARATE- VERBAND<br>E.V.      |  | GER - GERMANY |



# JUGEND KUMITE MÄDCHEN -47 K



# Offene Landesmeisterschaft Hessen und Rheinland -..

## ENTRIES BY WEIGHT CATEGORY

### Jugend Kumite Mädchen -47 kg

As of 4 FEB 2024

| NOC Code | Gender | Name              | Seeding |
|----------|--------|-------------------|---------|
| GER      | F      | Brettnacher Julie |         |
| GER      | F      | Giordano Alice    |         |
| GER      | F      | Mierig Emily      |         |
| GER      | F      | Staudt Samira     |         |
| GER      | F      | Wienbeck Rani     |         |

# Jugend Kumite Mädchen -47 kg

Offene Landesmeisterschaft Hessen und Rheinland - Pfalz 2024, Schulstraße 2, 69509 Mörlenbach, GER

2024-02-03

Tatami  
4 13:45

Pool  
1/1

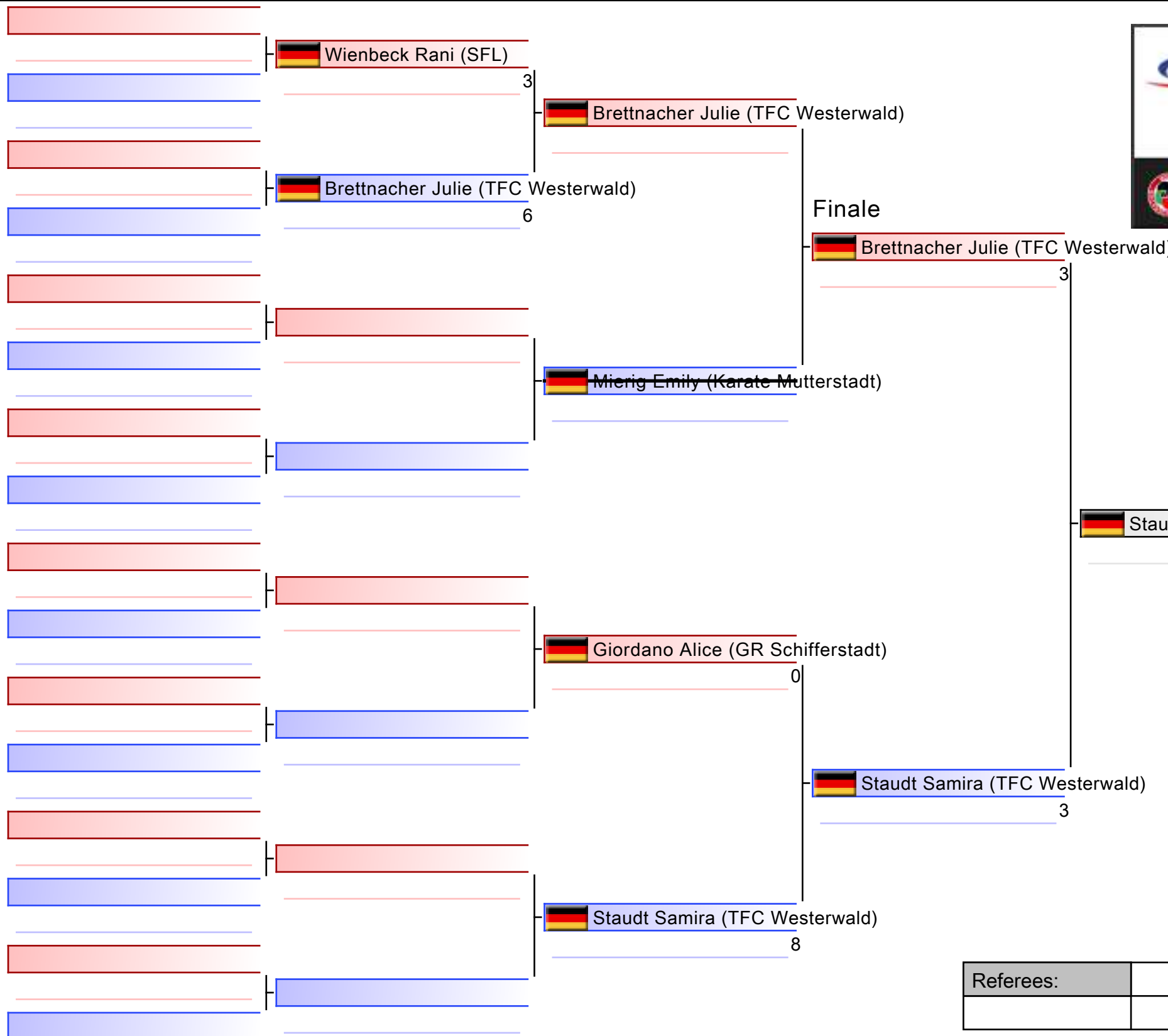

|                                       |
|---------------------------------------|
| 1. STAUDT SAMIRA (TFC WESTERWALD)     |
| 2. BRETTNACHER JULIE (TFC WESTERWALD) |
| 3. WIENBECK RANI (SFL)                |
| 3. GIORDANO ALICE (GR SCHIFFERSTADT)  |
|                                       |
|                                       |
|                                       |

|           |  |  |  |
|-----------|--|--|--|
| Referees: |  |  |  |
|           |  |  |  |



# Jugend Kumite Mädchen -47 kg

Offene Landesmeisterschaft Hessen und Rheinland - Pfalz 2024

2024-02-03

Tatami

4 14:00

Pool

1

(c)sportdata GmbH & Co KG 2000-2024 (2024-02-04 18:16) v 10.1.0 build 1 (2024-01-30 21:40 CET) Lizenz: Online\_Event\_ID-7816\_OffeneLandesmeisterschaftHessenundRheinlandPfalz2024 (expire 2024-02-18)

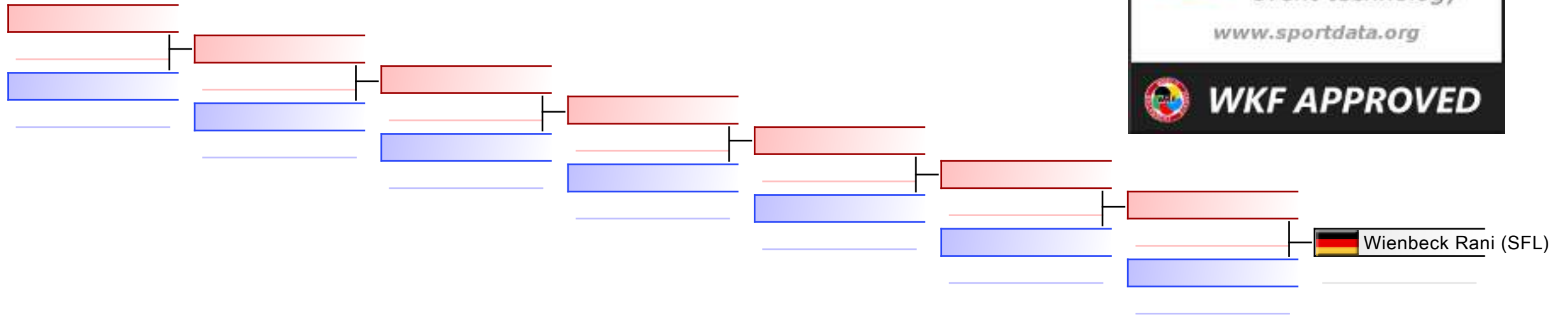

## TROSTRUNDE: (1)

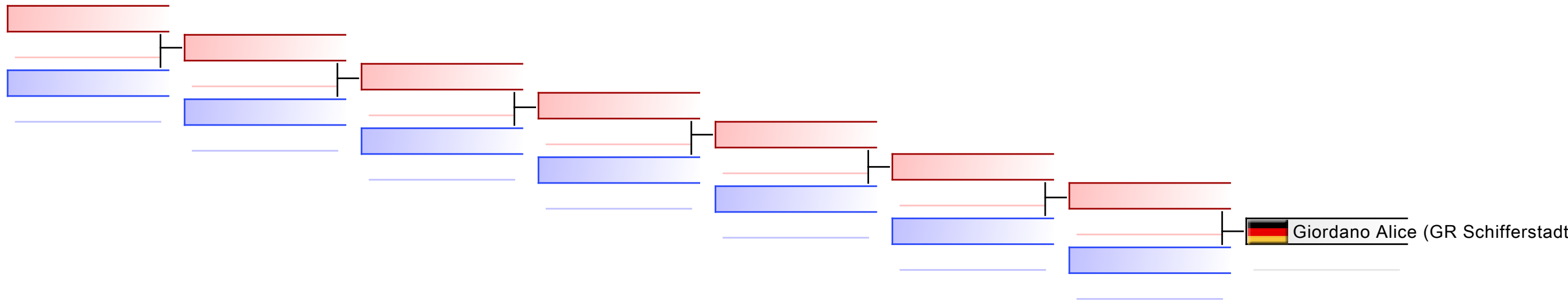

|           |  |  |  |  |  |  |  |
|-----------|--|--|--|--|--|--|--|
| Referees: |  |  |  |  |  |  |  |
|-----------|--|--|--|--|--|--|--|



Offene Landesmeisterschaft Hessen  
und Rheinland - Pfalz 2024 - 2024-02-03

Offizielle Ergebnisliste

| Jugend Kumite Mädchen -47 kg |                   |  |   |               |  |
|------------------------------|-------------------|--|---|---------------|--|
| 1                            | STAUDT SAMIRA     | TEAM FIGHTCLUB<br>WESTERWALD                   |  | GER - GERMANY |  |
| 2                            | BRETTNACHER JULIE | TEAM FIGHTCLUB<br>WESTERWALD                   |  | GER - GERMANY |  |
| 3                            | WIENBECK RANI     | SFL KARATE<br>BREMERHAVEN                      |  | GER - GERMANY |  |
| 3                            | GIORDANO ALICE    | GOJU-RYU<br>KARATEVEREIN<br>SCHIFFERSTADT E.V. |  | GER - GERMANY |  |

# JUGEND KUMITE MÄDCHEN -54 K



# Offene Landesmeisterschaft Hessen und Rheinland -..

## ENTRIES BY WEIGHT CATEGORY

Jugend Kumite Mädchen -54 kg

As of 4 FEB 2024

| NOC Code | Gender | Name             | Seeding |
|----------|--------|------------------|---------|
| GER      | F      | Damm Lisa-Maria  |         |
| GER      | F      | Hoheisel Paula   |         |
| GER      | F      | Igl Mia          |         |
| GER      | F      | Melnykova Emilia |         |
| GER      | F      | Stroh Venera     |         |

# Jugend Kumite Mädchen -54 kg

Offene Landesmeisterschaft Hessen und Rheinland - Pfalz 2024, Schulstraße 2, 69509 Mörlenbach, GER

2024-02-03

Tatami  
5 13:45

Pool  
1/1

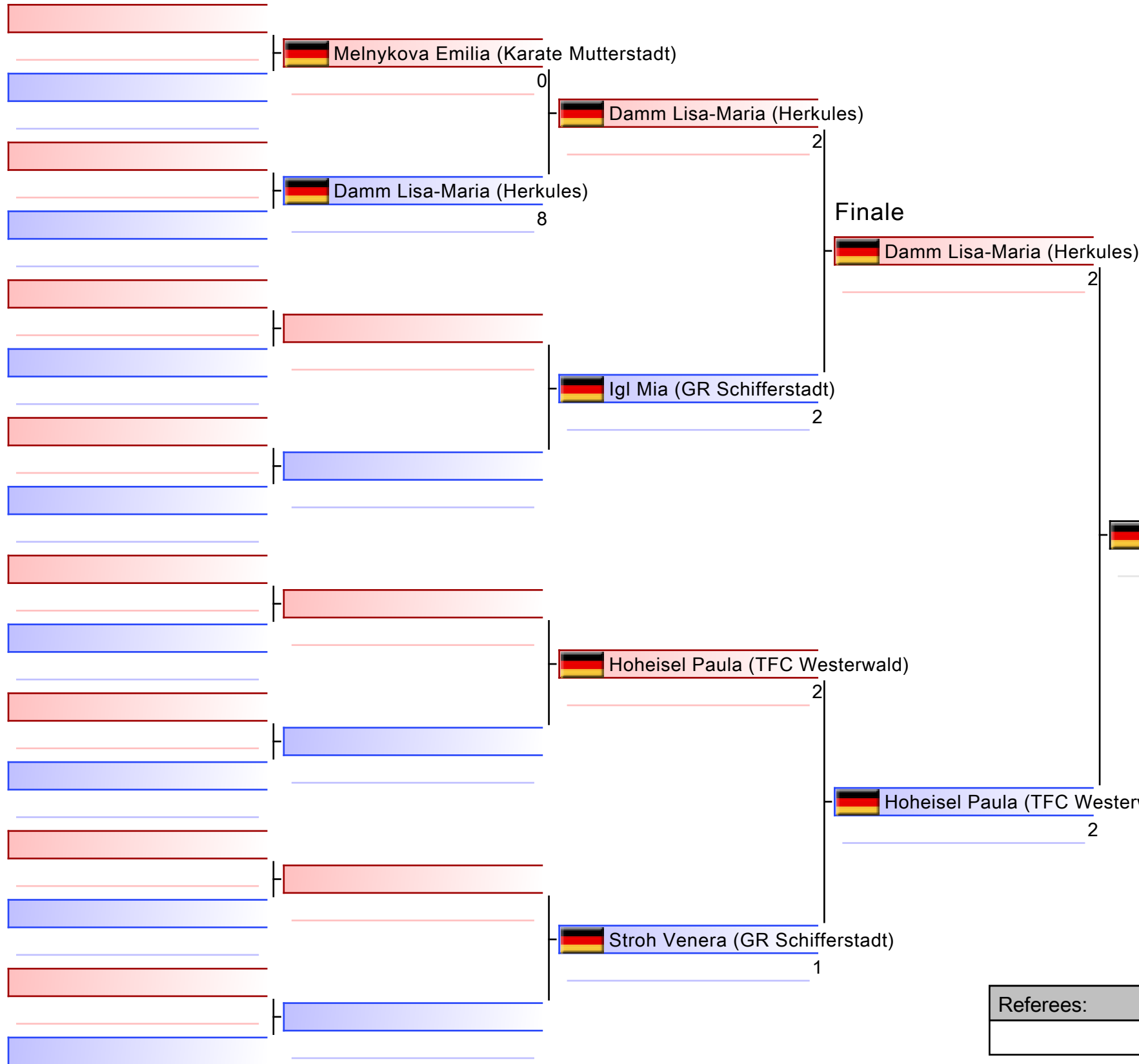

|  |
|--|
| 1. HOHEISEL PAULA (TFC WESTERWALD)       |
| 2. DAMM LISA-MARIA (HERKULES)            |
| 3. STROH VENERA (GR SCHIFFERSTADT)       |
| 3. IGL MIA (GR SCHIFFERSTADT)            |
| 5. MELNYKOVA EMILIA (KARATE MUTTERSTADT) |
|  |
|  |

|           |  |  |  |
|-----------|--|--|--|
| Referees: |  |  |  |
|           |  |  |  |

# Jugend Kumite Mädchen -54 kg

Offene Landesmeisterschaft Hessen und Rheinland - Pfalz 2024

2024-02-03

Tatami

5 14:00

Pool

1

(c)sportdata GmbH & Co KG 2000-2024 (2024-02-04 18:16) v 10.1.0 build 1 (2024-01-30 21:40 CET) Lizenz: Online\_Event\_ID-7816\_OffeneLandesmeisterschaftHessenundRheinlandPfalz2024 (expire 2024-02-18)

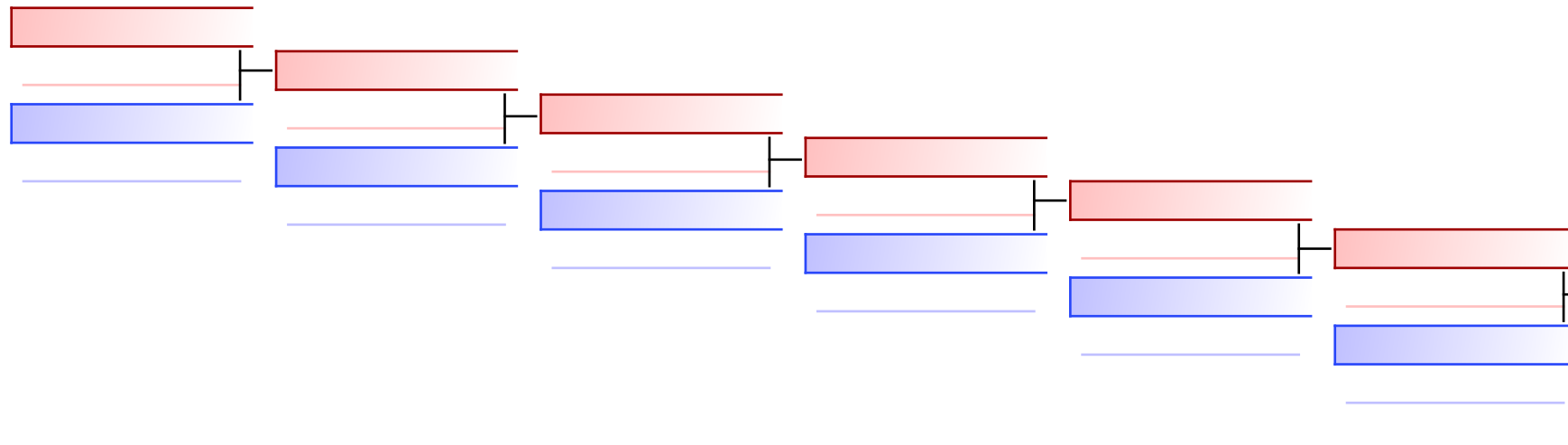

Melnykova Emilia (Karate Mutterstadt)  
0  
 Igl Mia (GR Schifferstadt)  
8

## TROSTRUNDE: (1)

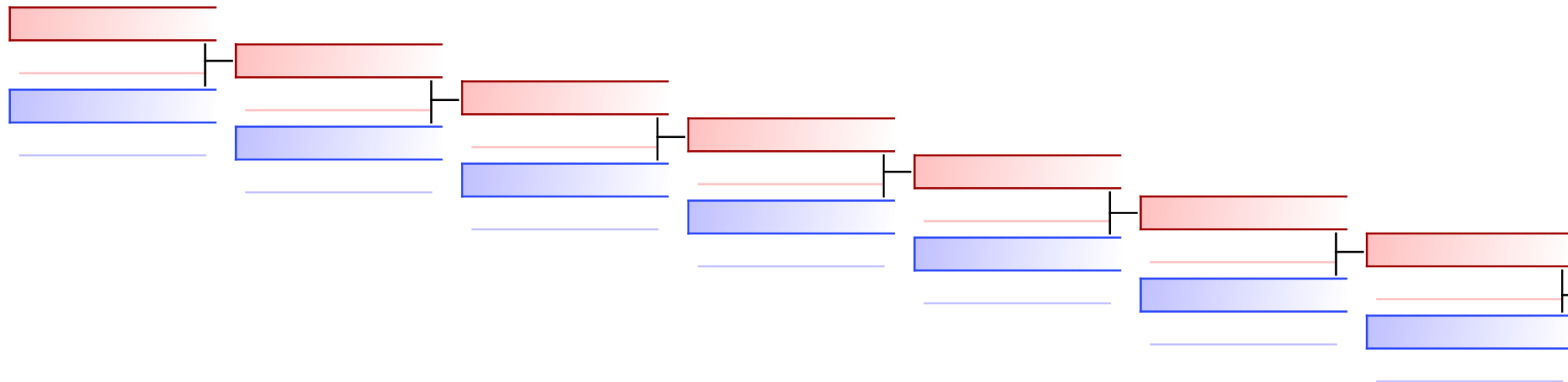

Stroh Venera (GR Schifferstadt)

|           |  |  |  |  |  |  |  |
|-----------|--|--|--|--|--|--|--|
| Referees: |  |  |  |  |  |  |  |
|-----------|--|--|--|--|--|--|--|



Offene Landesmeisterschaft Hessen  
und Rheinland - Pfalz 2024 - 2024-02-03

Offizielle Ergebnisliste

| Jugend Kumite Mädchen -54 kg |                  |  |  |               |
|------------------------------|------------------|--|--|---------------|
| 1                            | HOHEISEL PAULA   | TEAM FIGHTCLUB<br>WESTERWALD                   |  | GER - GERMANY |
| 2                            | DAMM LISA-MARIA  | SV HERKULES 01<br>KASSEL E.V.                  |  | GER - GERMANY |
| 3                            | STROH VENERA     | GOJU-RYU<br>KARATEVEREIN<br>SCHIFFERSTADT E.V. |  | GER - GERMANY |
| 3                            | IGL MIA          | GOJU-RYU<br>KARATEVEREIN<br>SCHIFFERSTADT E.V. |  | GER - GERMANY |
| 5                            | MELNYKOVA EMILIA | KARATE<br>MUTTERSTADT                          |  | GER - GERMANY |

# JUGEND KUMITE MÄDCHEN -61 K





# Offene Landesmeisterschaft Hessen und Rheinland -..

## ENTRIES BY WEIGHT CATEGORY

Jugend Kumite Mädchen -61 kg

As of 4 FEB 2024

| NOC Code | Gender | Name                  | Seeding |
|----------|--------|-----------------------|---------|
| GER      | F      | Abbas Fiza            |         |
| GER      | F      | Camuffo Debora        |         |
| GER      | F      | Chalcou-Freier Mahina |         |
| GER      | F      | Giegling Milena       |         |
| GER      | F      | Phok Davary           |         |
| GER      | F      | Rausch Lisa           |         |

# Jugend Kumite Mädchen -61 kg

Offene Landesmeisterschaft Hessen und Rheinland - Pfalz 2024, Schulstraße 2, 69509 Mörlenbach, GER

2024-02-03

Tatami  
3 13:45

Pool  
1/1

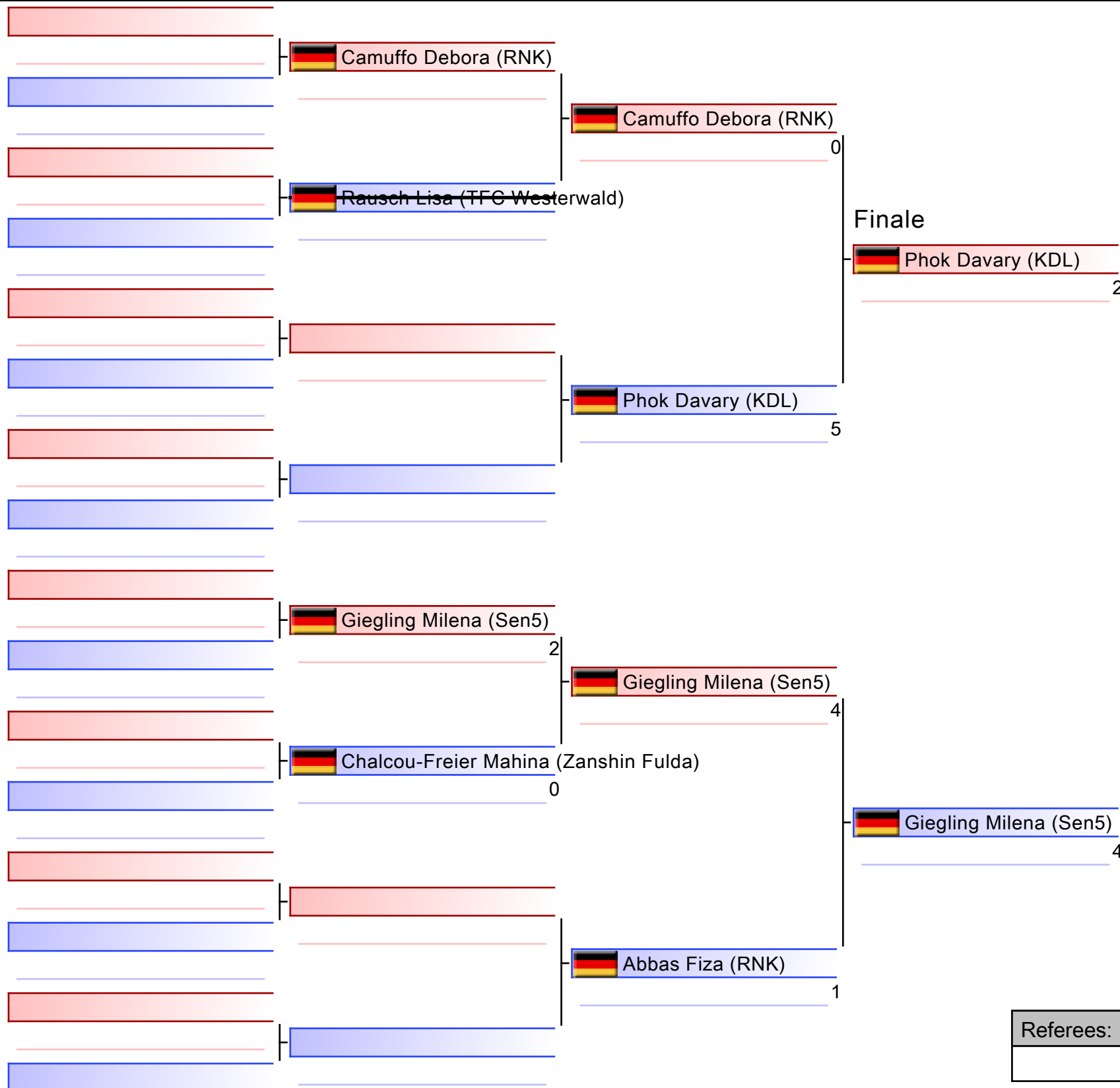

|  |
|--|
| 1. GIEGLING MILENA (SEN5)                |
| 2. PHOK DAVARY (KDL)                     |
| 3. CAMUFFO DEBORA (RNK)                  |
| 3. CHALCOU-FREIER MAHINA (ZANSHIN FULDA) |
| 5. ABBAS FIZA (RNK)                      |
|  |
|  |

|           |  |  |  |
|-----------|--|--|--|
| Referees: |  |  |  |
|           |  |  |  |

# Jugend Kumite Mädchen -61 kg

Offene Landesmeisterschaft Hessen und Rheinland - Pfalz 2024

2024-02-03

Tatami  
3 14:05

Pool  
1

(c)sportdata GmbH & Co KG 2000-2024 (2024-02-04 18:16) v 10.1.0 build 1 (2024-01-30 21:40 CET) Lizenz: Online\_Event\_ID-7816\_OffeneLandesmeisterschaftHessenundRheinlandPfalz2024 (expire 2024-02-18)

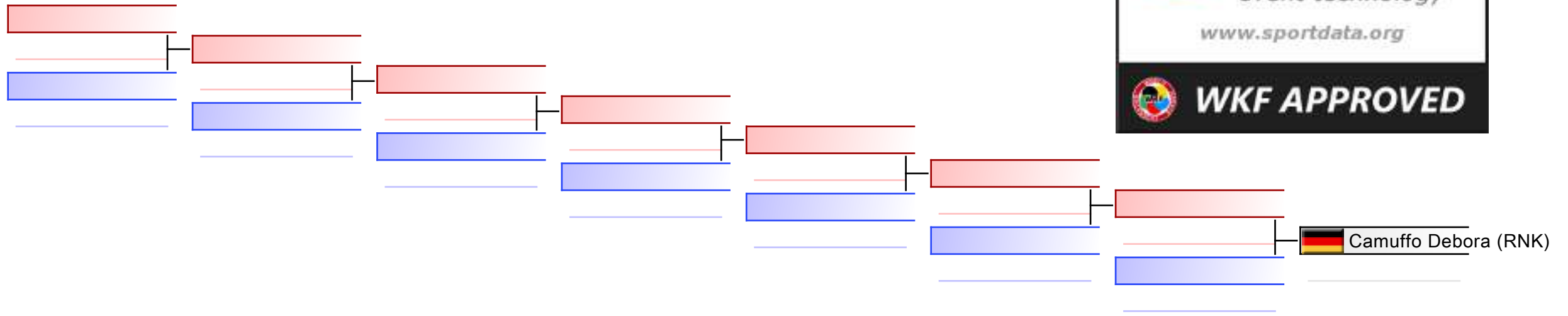

## TROSTRUNDE: (1)

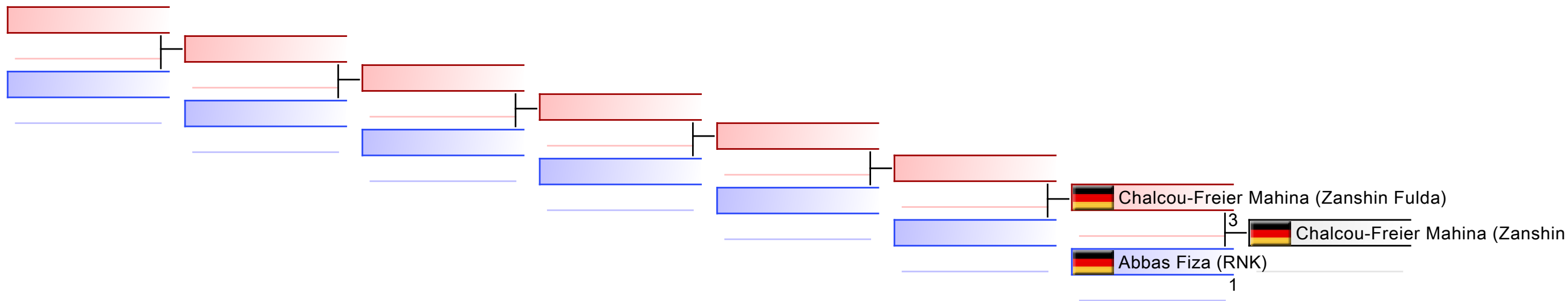

|           |  |  |  |  |  |  |  |
|-----------|--|--|--|--|--|--|--|
| Referees: |  |  |  |  |  |  |  |
|-----------|--|--|--|--|--|--|--|



Offene Landesmeisterschaft Hessen  
und Rheinland - Pfalz 2024 - 2024-02-03

Offizielle Ergebnisliste

| Jugend Kumite Mädchen -61 kg |                       |                              |   |               |
|------------------------------|-----------------------|------------------------------|---|---------------|
| 1                            | GIEGLING MILENA       | SEN5 KARATE<br>VEREIN E.V.   |  | GER - GERMANY |
| 2                            | PHOK DAVARY           | KARATE-DOJO LICH<br>E.V.     |  | GER - GERMANY |
| 3                            | CAMUFFO DEBORA        | RHEIN-NECKAR<br>KNIGHTS      |  | GER - GERMANY |
| 3                            | CHALCOU-FREIER MAHINA | ZANSHIN GRÜN-<br>WEISS FULDA |  | GER - GERMANY |
| 5                            | ABBAS FIZA            | RHEIN-NECKAR<br>KNIGHTS      |  | GER - GERMANY |



# JUGEND KUMITE TEAM JUNGEN



# Offene Landesmeisterschaft Hessen und Rheinland -..

## ENTRIES BY WEIGHT CATEGORY

### Jugend Kumite Team Jungen

As of 4 FEB 2024

| NOC Code | Gender | Name              | Seeding |
|----------|--------|-------------------|---------|
| GER      | M      | Ay Mirhat         |         |
| GER      | M      | Becker Finley     |         |
| GER      | M      | Becker Yannik     |         |
| GER      | M      | Breisch Sebastian |         |
| GER      | M      | Chnykin Kiril     |         |
| GER      | M      | Guidouche Yacoub  |         |
| GER      | M      | Hackel Fynn       |         |
| GER      | M      | Kurz Phil         |         |
| GER      | M      | Lenk Christian    |         |
| GER      | M      | Lubenets Daniel   |         |
| GER      | M      | Mezhlumova David  |         |
| GER      | M      | Niederelz Tim     |         |
| GER      | M      | Spoehr Tom Angus  |         |
| GER      | M      | Stach Daniel      |         |
| GER      | M      | Swidersky Ben     |         |
| GER      | M      | Tschumarow Andrej |         |
| GER      | M      | Ueberfeld Fabian  |         |

# Jugend Kumite Team Jungen

Offene Landesmeisterschaft Hessen und Rheinland - Pfalz 2024, Schulstraße 2, 69509 Mörlenbach, GER

2024-02-03

Tatami  
4 15:10

Pool  
1/1

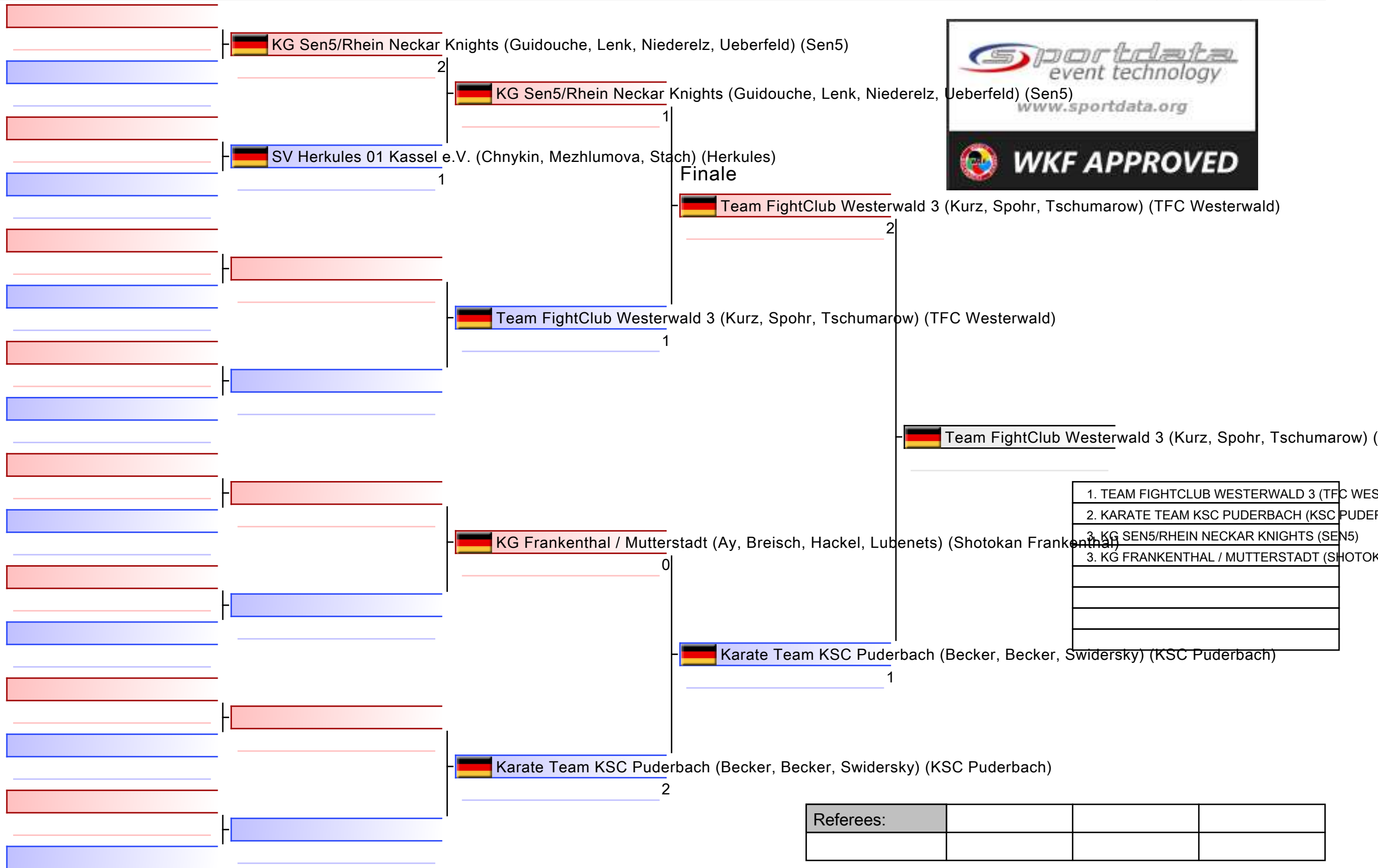

# Jugend Kumite Team Jungen

Offene Landesmeisterschaft Hessen und Rheinland - Pfalz 2024

2024-02-03

Tatami

3 15:35

Pool

1

(c)sportdata GmbH & Co KG 2000-2024 (2024-02-04 18:16) v 10.1.0 build 1 (2024-01-30 21:40 CET) Lizenz: Online\_Event\_ID-7816\_OffeneLandesmeisterschaftHessenundRheinlandPfalz2024 (expire 2024-02-18)

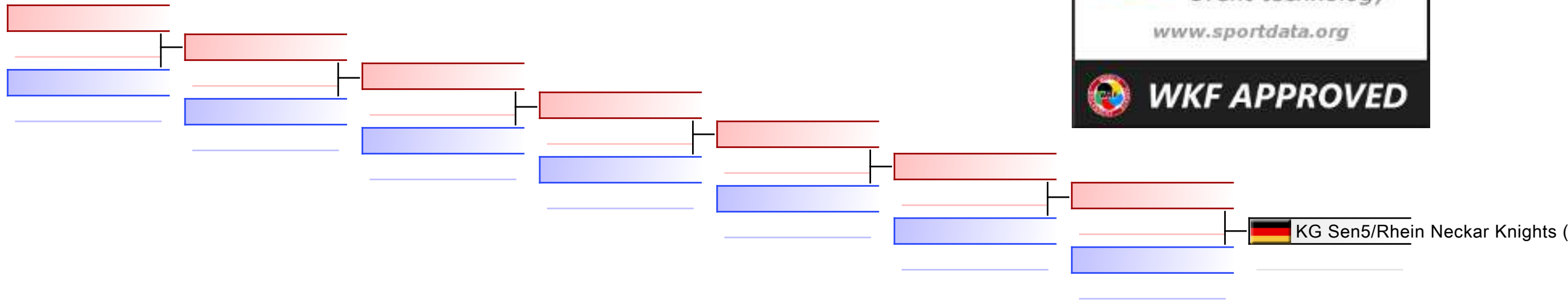

## TROSTRUNDE: (1)

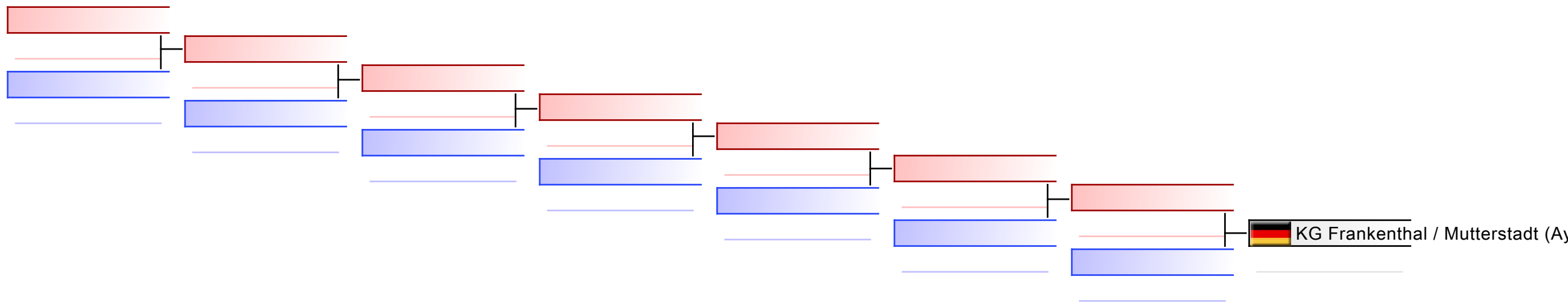

|           |  |  |  |  |  |  |  |
|-----------|--|--|--|--|--|--|--|
| Referees: |  |  |  |  |  |  |  |
|-----------|--|--|--|--|--|--|--|





Offene Landesmeisterschaft Hessen  
und Rheinland - Pfalz 2024 - 2024-02-03

Offizielle Ergebnisliste

| Jugend Kumite Team Jungen |  |  |  |               |  |
|---------------------------|--|--|--|---------------|--|
| 1                         | TEAM FIGHTCLUB<br>WESTERWALD 3<br>- TSCHUMAROW ANDREJ<br>- SPOHR TOM_ANGUS<br>- KURZ PHIL                          | TEAM FIGHTCLUB<br>WESTERWALD                   |  | GER - GERMANY |  |
| 2                         | KARATE TEAM KSC<br>PUDERBACH<br>- SWIDERSKY BEN<br>- BECKER YANNIK<br>- BECKER FINLEY                              | KARATE TEAM KSC<br>PUDERBACH                   |  | GER - GERMANY |  |
| 3                         | KG SEN5/RHEIN NECKAR<br>KNIGHTS<br>- GUIDOUCHE YACOUB<br>- LENK CHRISTIAN<br>- NIEDERELZ TIM<br>- UEBERFELD FABIAN | SEN5 KARATE<br>VEREIN E.V.                     |  | GER - GERMANY |  |
| 3                         | KG FRANKENTHAL /<br>MUTTERSTADT<br>- AY MIRHAT<br>- BREISCH SEBASTIAN<br>- HACKEL FYNN<br>- LUBENETS DANIEL        | 1. SHOTOKAN<br>KARATE CLUB<br>FRANKENTHAL E.V. |  | GER - GERMANY |  |



# JUGEND KUMITE TEAM MÄDCHEN



# Offene Landesmeisterschaft Hessen und Rheinland -..

## ENTRIES BY WEIGHT CATEGORY

### Jugend Kumite Team Mädchen

As of 4 FEB 2024

| NOC Code | Gender | Name              | Seeding |
|----------|--------|-------------------|---------|
| GER      | F      | Brettnacher Julie |         |
| GER      | F      | Giegling Milena   |         |
| GER      | F      | Giordano Alice    |         |
| GER      | F      | Hoheisel Paula    |         |
| GER      | F      | Igl Mia           |         |
| GER      | F      | Phok Davary       |         |
| GER      | F      | Rausch Lisa       |         |
| GER      | F      | Schindler Miley   |         |
| GER      | F      | Staudt Samira     |         |
| GER      | F      | Stroh Venera      |         |
| GER      | F      | Weißemeyer Emilia |         |

# Jugend Kumite Team Mädchen

Offene Landesmeisterschaft Hessen und Rheinland - Pfalz 2024, Schulstraße 2, 69509 Mörlenbach, GER

2024-02-03

Tatami

5 15:15

Pool

1/1

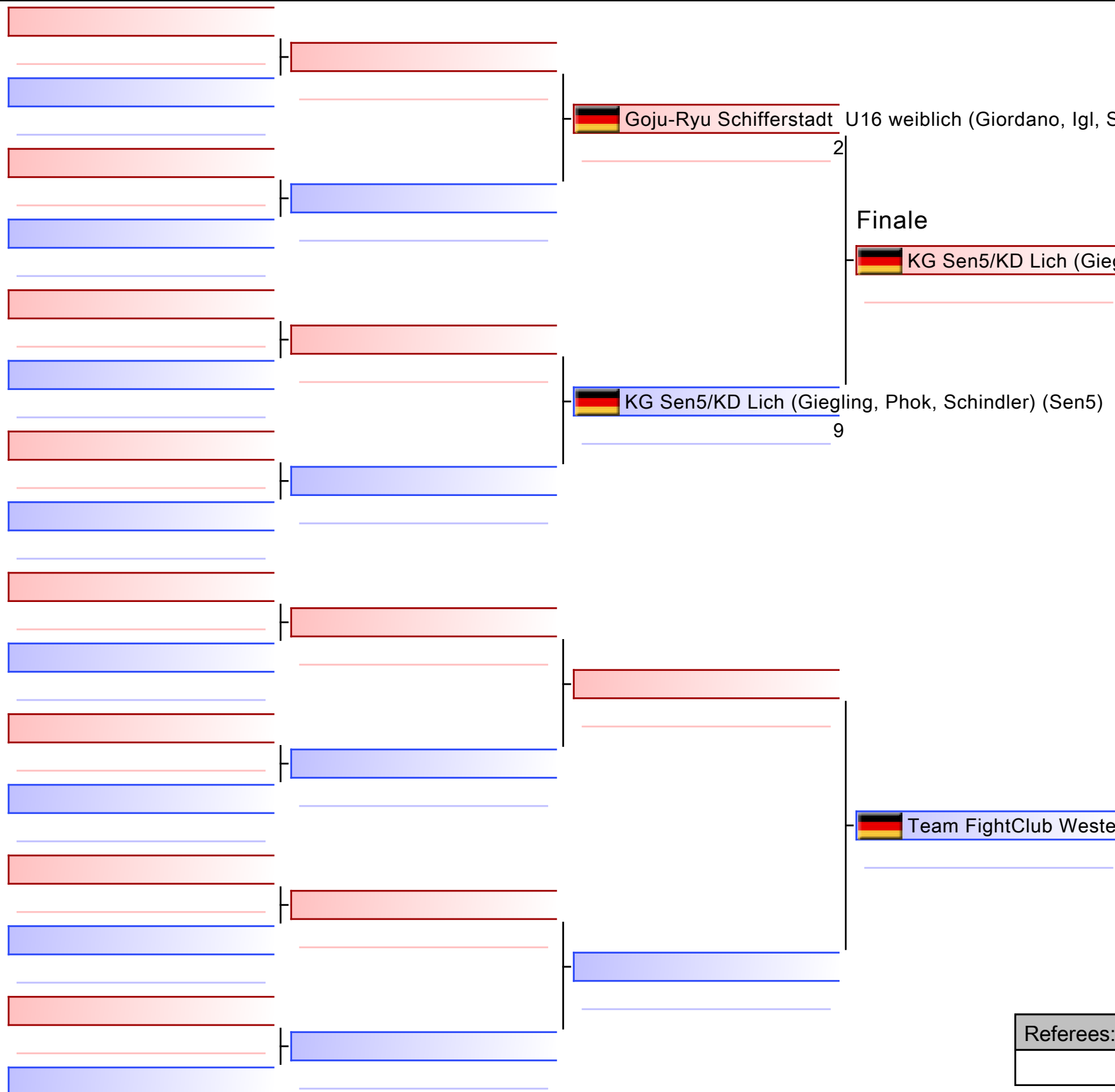

Goju-Ryu Schifferstadt U16 weiblich (Giordano, Igl, Stroh, Weißenmeyer) (GR Schifferstadt)

2

Finale

KG Sen5/KD Lich (Giegling, Phok, Schindler) (Sen5)

2

KG Sen5/KD Lich (Giegling, Phok, Schindler) (Sen5)

9

KG Sen5/KD Lich (Giegling, Phok, Schindler) (Sen5)

|   |
|---|
| 1. KG SEN5/KD LICH (SEN5)                                 |
| 2. TEAM FIGHTCLUB WESTERWALD 1 (TFC WESTERWALD)           |
| 3. GOJU-RYU SCHIFFERSTADT U16 WEIBLICH (GR SCHIFFERSTADT) |
|   |
|   |
|   |
|   |

Team FightClub Westerwald 1 (Brettnacher, Hoheisel, Rausch, Staudt) (TFC Westerwald)

0

|           |  |  |  |
|-----------|--|--|--|
| Referees: |  |  |  |
|           |  |  |  |

# Jugend Kumite Team Mädchen

Offene Landesmeisterschaft Hessen und Rheinland - Pfalz 2024

Tatami

Pool

1

(c)sportdata GmbH & Co KG 2000-2024 (2024-02-04 18:16) v 10.1.0 build 1 (2024-01-30 21:40 CET) Lizenz: Online\_Event\_ID-7816\_OffeneLandesmeisterschaftHessenundRheinlandPfalz2024 (expire 2024-02-18)

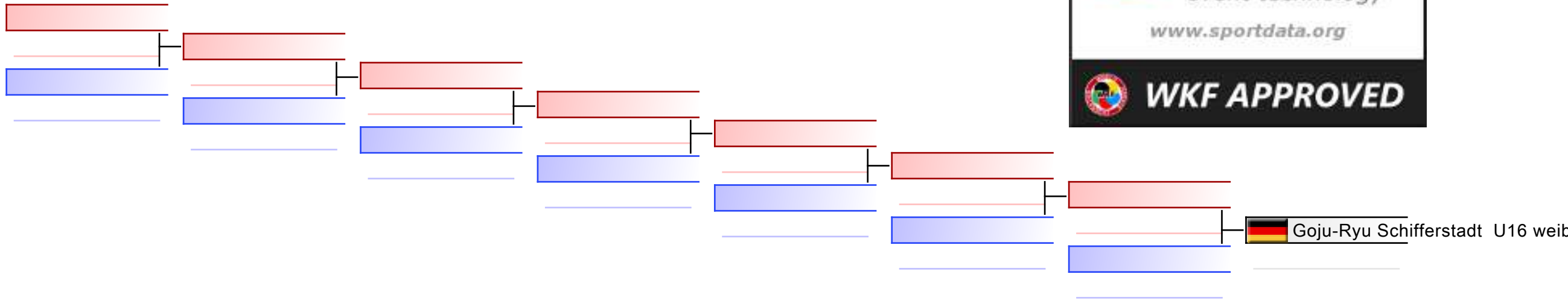

## TROSTRUNDE: (1)

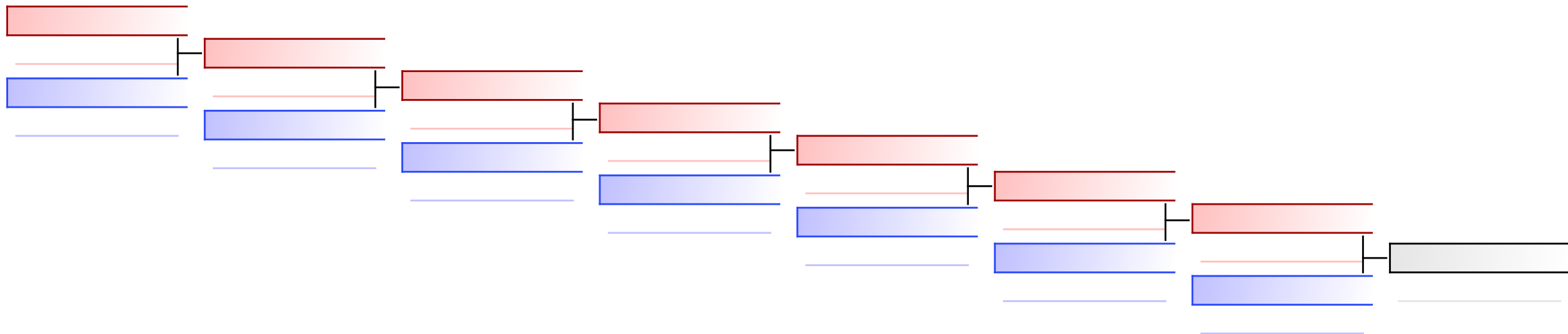

|           |  |  |  |  |  |  |  |
|-----------|--|--|--|--|--|--|--|
| Referees: |  |  |  |  |  |  |  |
|-----------|--|--|--|--|--|--|--|



Offene Landesmeisterschaft Hessen  
und Rheinland - Pfalz 2024 - 2024-02-03

Offizielle Ergebnisliste

| Jugend Kumite Team Mädchen |  |  |   |               |
|----------------------------|--|--|---|---------------|
| 1                          | KG SEN5/KD LICH<br>- GIEGLING MILENA<br>- PHOK DAVARY<br>- SCHINDLER MILEY   | SEN5 KARATE<br>VEREIN E.V.                     |  | GER - GERMANY |
| 2                          | TEAM FIGHTCLUB<br>WESTERWALD 1<br>- BRETTNACHER JULIE<br>- STAUDT SAMIRA<br>- RAUSCH LISA<br>- HOHEISEL PAULA      | TEAM FIGHTCLUB<br>WESTERWALD                   |  | GER - GERMANY |
| 3                          | GOJU-RYU SCHIFFERSTADT<br>U16 WEIBLICH<br>- STROH VENERA<br>- IGL MIA<br>- GIORDANO ALICE<br>- WEISSENMEYER EMILIA | GOJU-RYU<br>KARATEVEREIN<br>SCHIFFERSTADT E.V. |  | GER - GERMANY |



# JUNIOREN KATA JUNGEN



# Offene Landesmeisterschaft Hessen und Rheinland -..

## ENTRIES BY WEIGHT CATEGORY

### Junioren Kata Jungen

As of 4 FEB 2024

| NOC Code | Gender | Name                   | Seeding |
|----------|--------|------------------------|---------|
| GER      | M      | Becker Sebastian Kawin |         |
| GER      | M      | Gschwind Victor        |         |
| GER      | M      | Hartmann Jörn          |         |
| GER      | M      | Koch Alexander         |         |
| GER      | M      | Kuznetsov Wladlen      |         |
| GER      | M      | Schwarz Elias Erwan    |         |
| GER      | M      | Spies Maarten          |         |



# Junioren Kata Jungen

Offene Landesmeisterschaft Hessen und Rheinland - Pfalz 2024, Schulstraße 2, 69509 Mörlenbach, GER

2024-02-03

Tatami  
5 09:15

Pool  
1/1

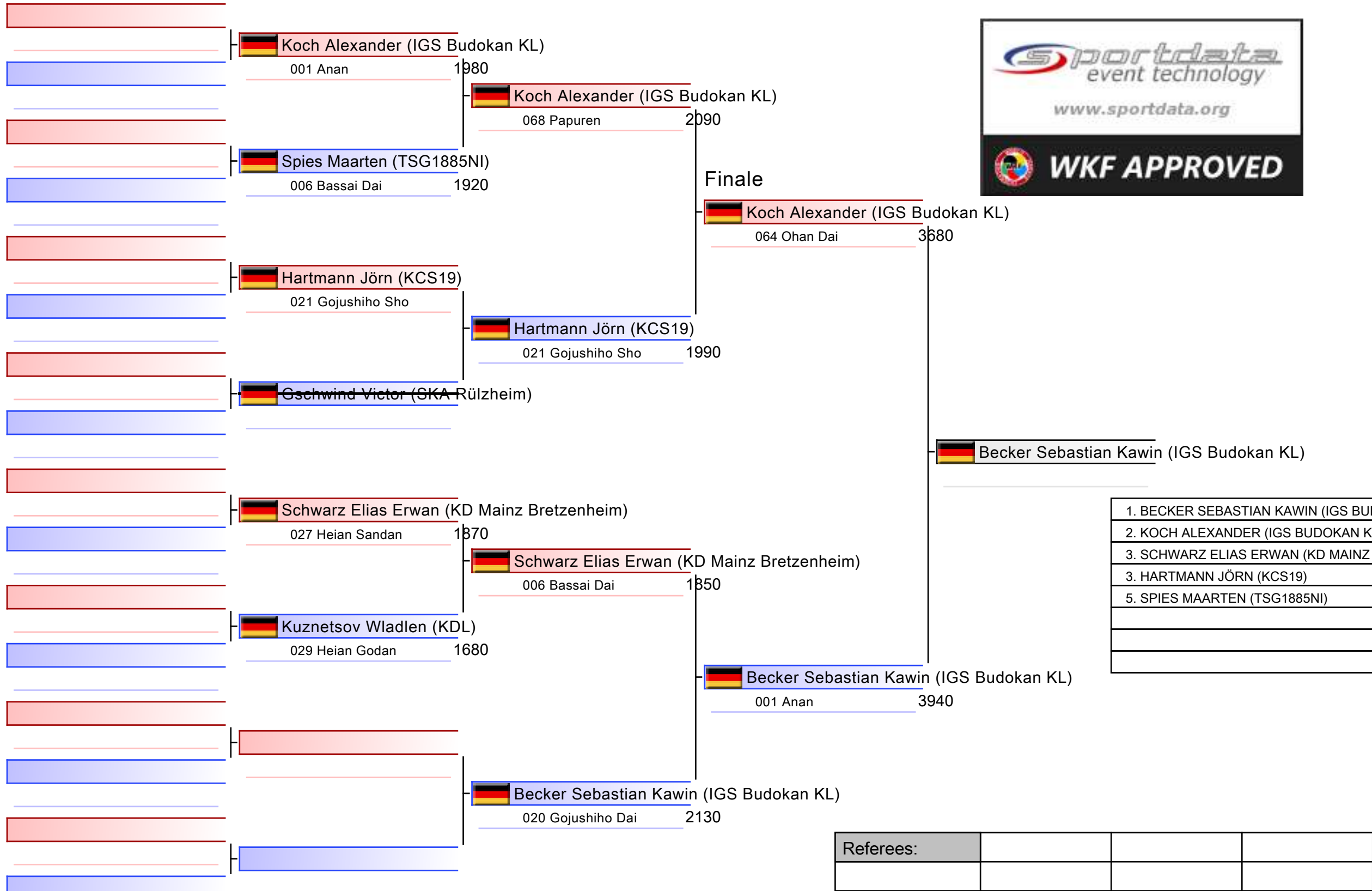

|   |
|---|
| 1. BECKER SEBASTIAN KAWIN (IGS BUDOKAN KL)    |
| 2. KOCH ALEXANDER (IGS BUDOKAN KL)            |
| 3. SCHWARZ ELIAS ERWAN (KD MAINZ BRETZENHEIM) |
| 3. HARTMANN JÖRN (KCS19)                      |
| 5. SPIES MAARTEN (TSG1885NI)                  |
|   |
|   |

|           |  |  |  |
|-----------|--|--|--|
| Referees: |  |  |  |
|           |  |  |  |

# Junioren Kata Jungen

Offene Landesmeisterschaft Hessen und Rheinland - Pfalz 2024

2024-02-03

Tatami  
5 09:45

Pool  
1

(c)sportdata GmbH & Co KG 2000-2024 (2024-02-04 18:16) v 10.1.0 build 1 (2024-01-30 21:40 CET) Lizenz: Online\_Event\_ID-7816\_OffeneLandesmeisterschaftHessenundRheinlandPfalz2024 (expire 2024-02-18)

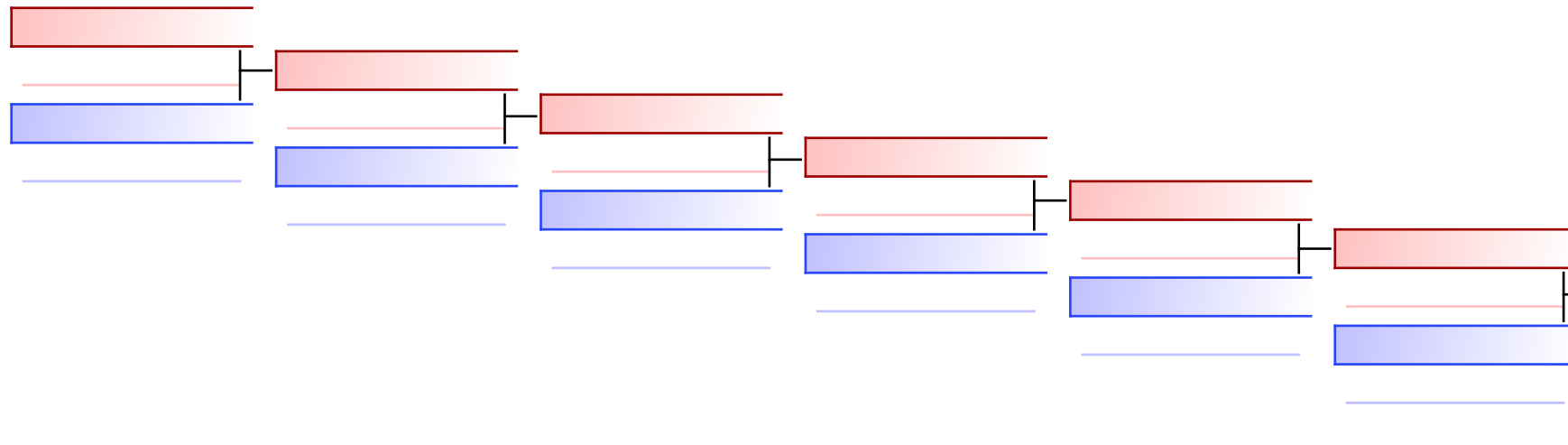

Spies Maarten (TSG1885NI)  
021 Gojushiho. 3080

Hartmann Jörn (KCS19)  
041 Kanku Sho 3300

## TROSTRUNDE: (1)

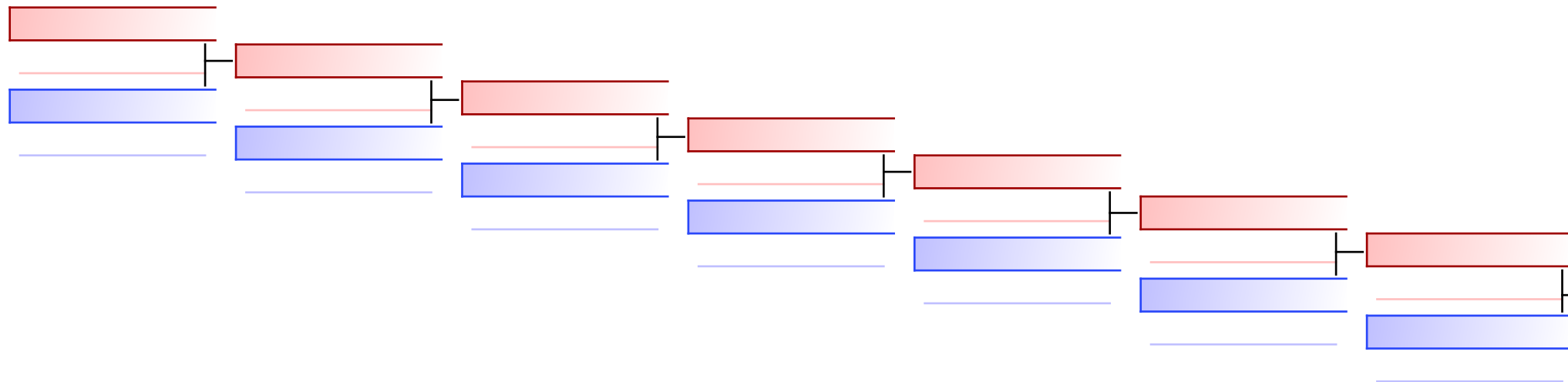

Schwarz Elias Erwan (KD Mainz)

|           |  |  |  |  |  |  |  |
|-----------|--|--|--|--|--|--|--|
| Referees: |  |  |  |  |  |  |  |
|-----------|--|--|--|--|--|--|--|



Offene Landesmeisterschaft Hessen  
und Rheinland - Pfalz 2024 - 2024-02-03

Offizielle Ergebnisliste

| Junioren Kata Jungen |                        |                                       |  |               |  |
|----------------------|------------------------|---------------------------------------|--|---------------|--|
| 1                    | BECKER SEBASTIAN KAWIN | IGS BUDOKAN<br>KAISERSLAUTERN         |  | GER - GERMANY |  |
| 2                    | KOCH ALEXANDER         | IGS BUDOKAN<br>KAISERSLAUTERN         |  | GER - GERMANY |  |
| 3                    | SCHWARZ ELIAS ERWAN    | KARATE DOJO MAINZ<br>BRETZENHEIM E.V. |  | GER - GERMANY |  |
| 3                    | HARTMANN JÖRN          | KARATE CLUB<br>SPEYER E.V.            |  | GER - GERMANY |  |
| 5                    | SPIES MAARTEN          | TSG 1885 NEU<br>ISENBURG              |  | GER - GERMANY |  |

# JUNIOREN KATA MÄDCHEN



# Offene Landesmeisterschaft Hessen und Rheinland -..

## ENTRIES BY WEIGHT CATEGORY

### Junioren Kata Mädchen

As of 4 FEB 2024

| NOC Code | Gender | Name                  | Seeding |
|----------|--------|-----------------------|---------|
| GER      | F      | Akinci Azra Ayse      |         |
| GER      | F      | Jürgens Melina Samira |         |
| GER      | F      | Nethe Sonja Truc Xuan |         |
| GER      | F      | Poh Nadine Sophie     |         |
| GER      | F      | Weber Jana            |         |
| GER      | F      | Wisser Annika         |         |
| GER      | F      | Özer Genet            |         |

# Junioren Kata Mädchen

Offene Landesmeisterschaft Hessen und Rheinland - Pfalz 2024, Schulstraße 2, 69509 Mörlenbach, GER

2024-02-03

Tatami  
6 09:15

Pool  
1/1

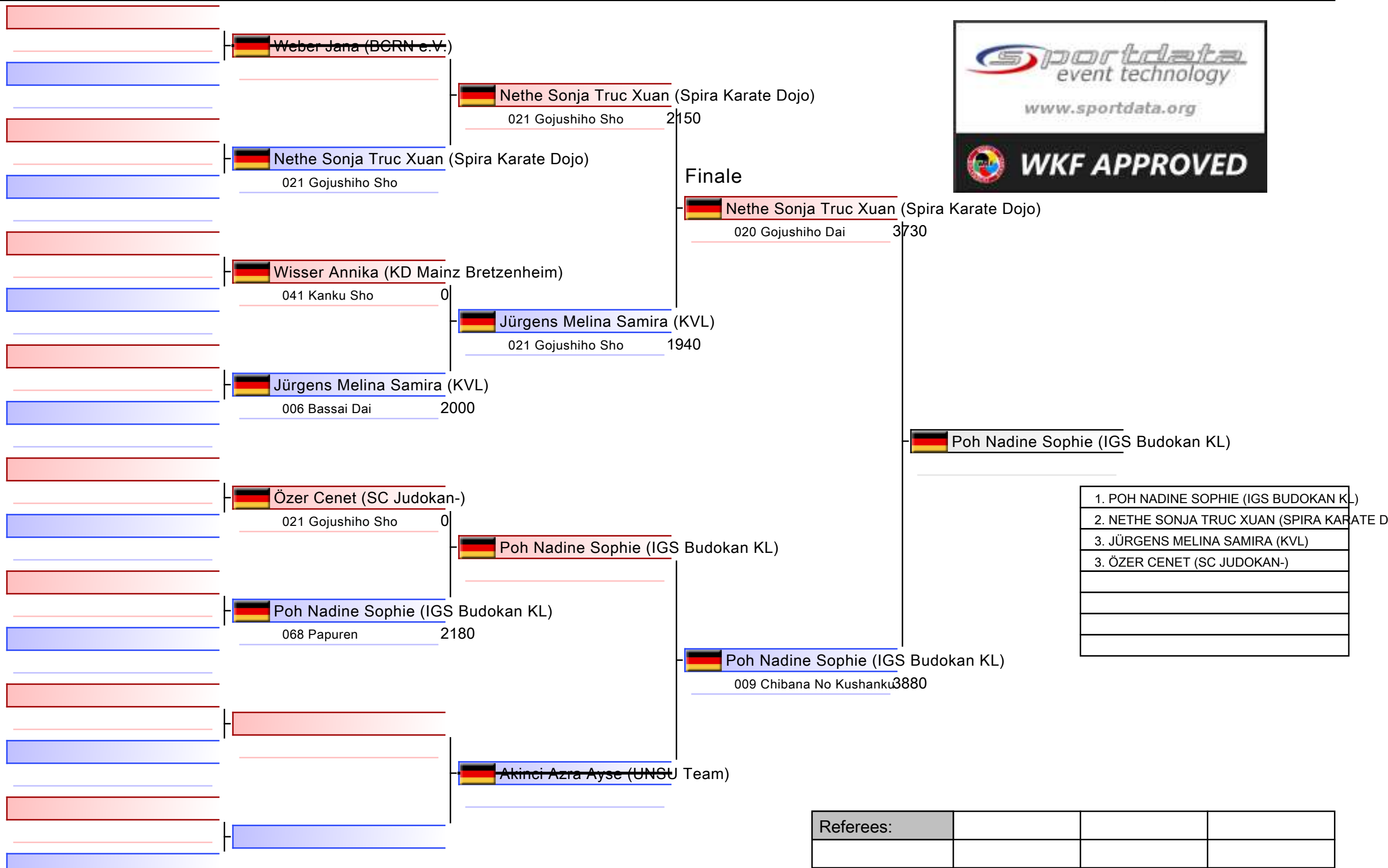

# Junioren Kata Mädchen

Offene Landesmeisterschaft Hessen und Rheinland - Pfalz 2024

2024-02-03

Tatami  
6 09:45

Pool  
1

(c)sportdata GmbH & Co KG 2000-2024 (2024-02-04 18:16) v 10.1.0 build 1 (2024-01-30 21:40 CET) Lizenz: Online\_Event\_ID-7816\_OffeneLandesmeisterschaftHessenundRheinlandPfalz2024 (expire 2024-02-18)

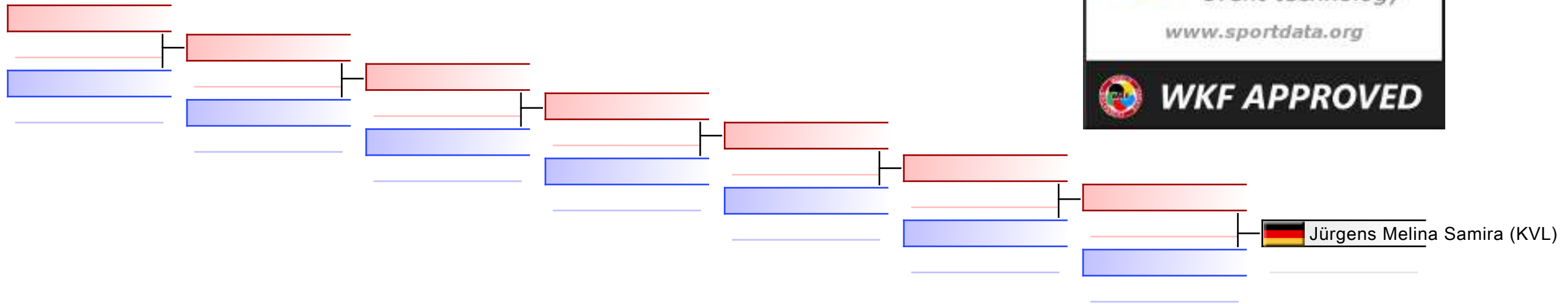

## TROSTRUNDE: (1)

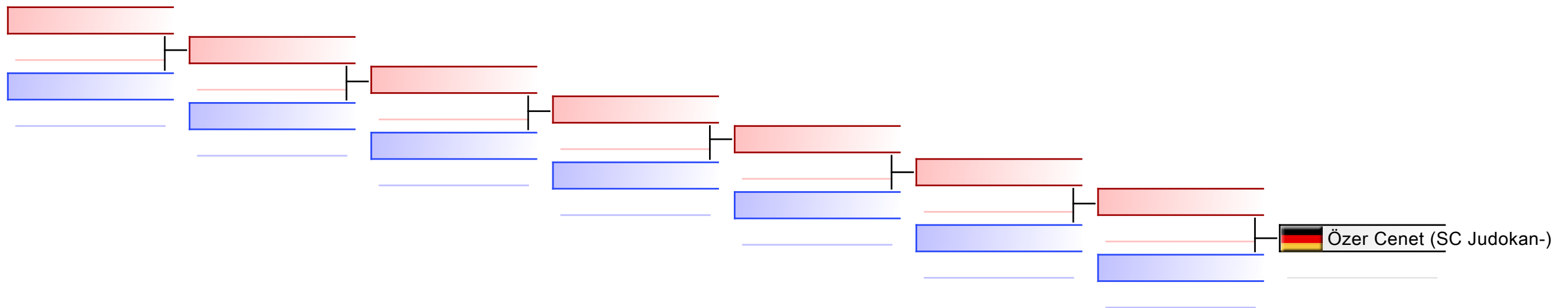

|           |  |  |  |  |  |  |  |
|-----------|--|--|--|--|--|--|--|
| Referees: |  |  |  |  |  |  |  |
|-----------|--|--|--|--|--|--|--|



Offene Landesmeisterschaft Hessen  
und Rheinland - Pfalz 2024 - 2024-02-03

Offizielle Ergebnisliste

| Junioren Kata Mädchen |                       |                                    |   |               |  |
|-----------------------|-----------------------|------------------------------------|---|---------------|--|
| 1                     | POH NADINE SOPHIE     | IGS BUDOKAN<br>KAISERSLAUTERN      |  | GER - GERMANY |  |
| 2                     | NETHE SONJA TRUC XUAN | SHOTOKAN KARATE<br>DOJO SPIRA E.V. |  | GER - GERMANY |  |
| 3                     | JÜRGENS MELINA SAMIRA | KARATE-VEREIN<br>LANGEN E.V.       |  | GER - GERMANY |  |
| 3                     | ÖZER CENET            | SC JUDOKAN E.V.                    |  | GER - GERMANY |  |



# JUNIOREN KUMITE JUNGEN +76 kg



# Offene Landesmeisterschaft Hessen und Rheinland -..

## ENTRIES BY WEIGHT CATEGORY

Junioren Kumite Jungen +76 kg

As of 4 FEB 2024

| NOC Code | Gender | Name               | Seeding |
|----------|--------|--------------------|---------|
| GER      | M      | Glowniewski Jeremy |         |
| GER      | M      | Gumpelstetter Timo |         |
| GER      | M      | Kurtanovic Armin   |         |
| GER      | M      | Rath Konstantin    |         |
| GER      | M      | Ridiger Eric       |         |

# Junioren Kumite Jungen +76 kg

Offene Landesmeisterschaft Hessen und Rheinland - Pfalz 2024, Schulstraße 2, 69509 Mörlenbach, GER

2024-02-03

Tatami  
2 14:40

Pool  
1/1

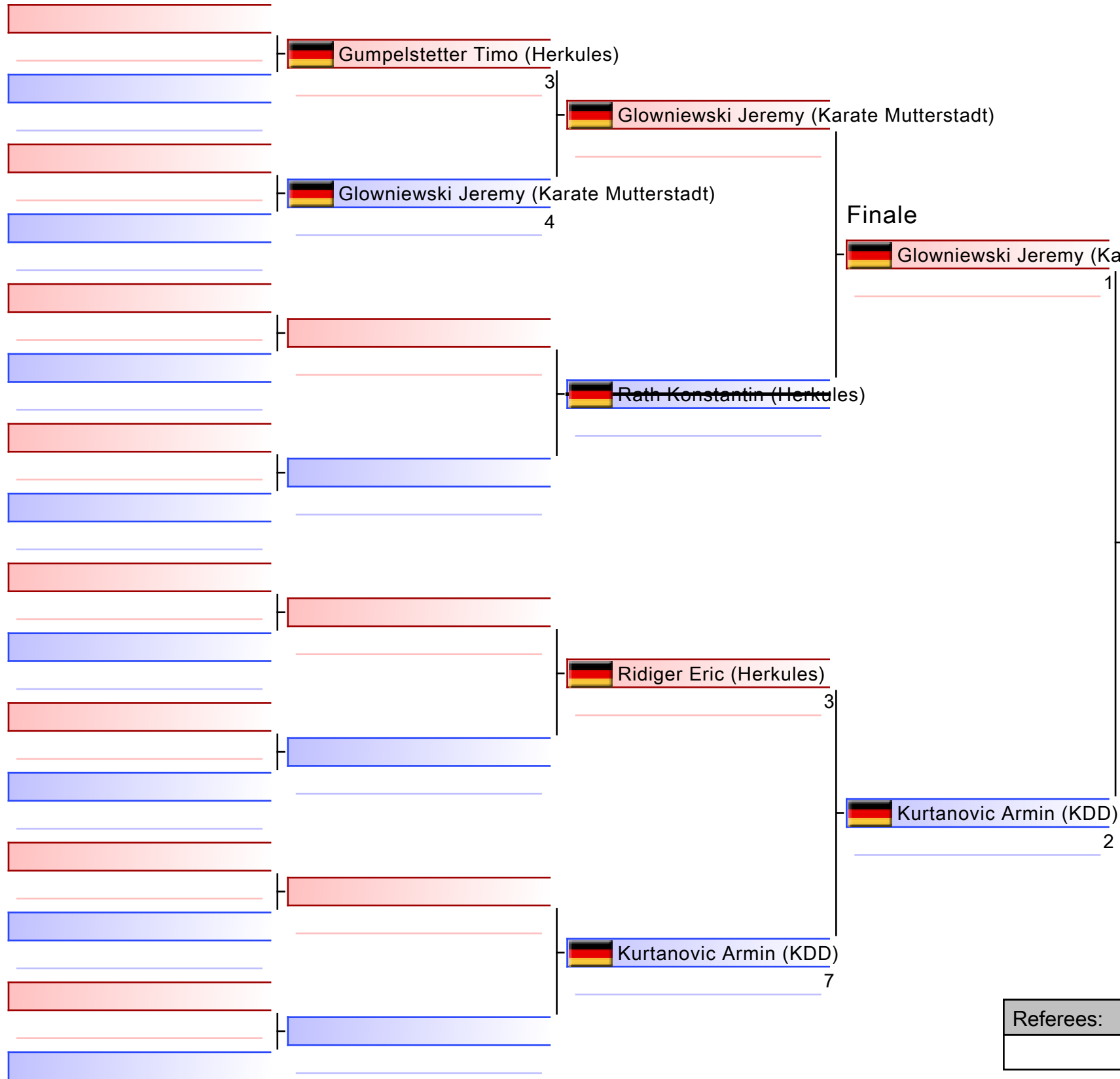

|  |
|--|
| 1. KURTANOVIC ARMIN (KDD)                  |
| 2. GLOWNIEWSKI JEREMY (KARATE MUTTERSTADT) |
| 3. GUMPELSTETTER TIMO (HERKULES)           |
| 3. RIDIGER ERIC (HERKULES)                 |
|  |
|  |
|  |

|           |  |  |  |
|-----------|--|--|--|
| Referees: |  |  |  |
|           |  |  |  |

# Junioren Kumite Jungen +76 kg

Offene Landesmeisterschaft Hessen und Rheinland - Pfalz 2024

2024-02-03

Tatami

2 14:55

Pool

1

(c)sportdata GmbH & Co KG 2000-2024 (2024-02-04 18:16) v 10.1.0 build 1 (2024-01-30 21:40 CET) Lizenz: Online\_Event\_ID-7816\_OffeneLandesmeisterschaftHessenundRheinlandPfalz2024 (expire 2024-02-18)

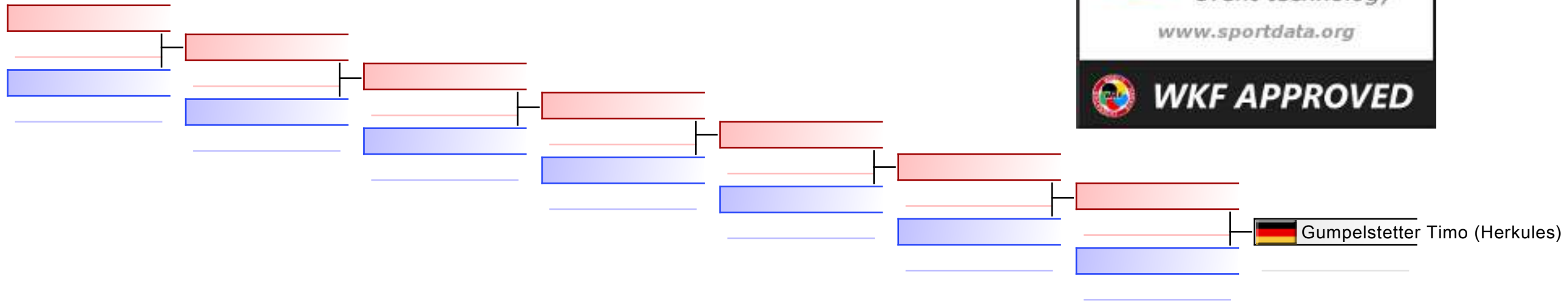

## TROSTRUNDE: (1)

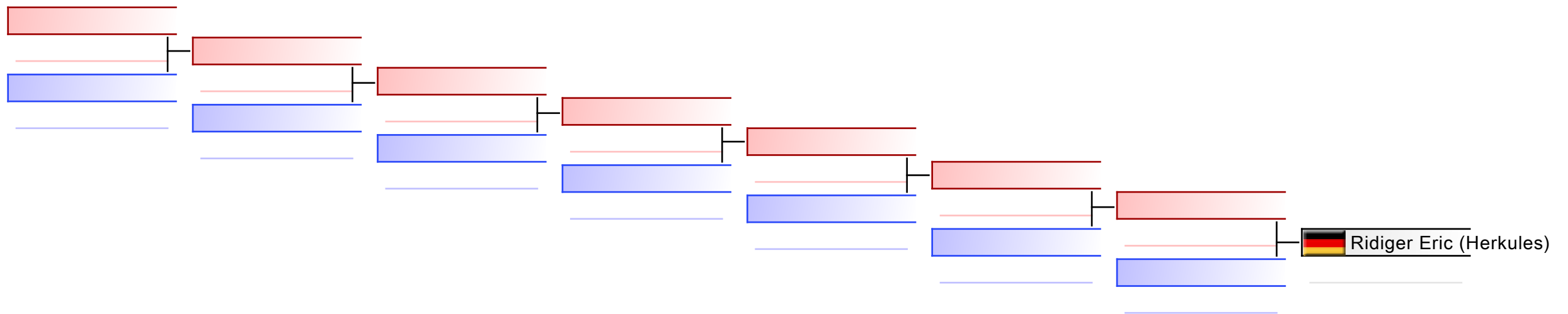

|           |  |  |  |  |  |  |  |
|-----------|--|--|--|--|--|--|--|
| Referees: |  |  |  |  |  |  |  |
|-----------|--|--|--|--|--|--|--|



Offene Landesmeisterschaft Hessen  
und Rheinland - Pfalz 2024 - 2024-02-03

Offizielle Ergebnisliste

| Junioren Kumite Jungen +76 kg |                    |                               |   |               |
|-------------------------------|--------------------|-------------------------------|---|---------------|
| 1                             | KURTANOVIC ARMIN   | KARATE DOJO<br>DIETZENBACH    |  | GER - GERMANY |
| 2                             | GLOWNIEWSKI JEREMY | KARATE<br>MUTTERSTADT         |  | GER - GERMANY |
| 3                             | GUMPELSTETTER TIMO | SV HERKULES 01<br>KASSEL E.V. |  | GER - GERMANY |
| 3                             | RIDIGER ERIC       | SV HERKULES 01<br>KASSEL E.V. |  | GER - GERMANY |



# JUNIOREN KUMITE JUNGEN -55 K



# Offene Landesmeisterschaft Hessen und Rheinland -..

## ENTRIES BY WEIGHT CATEGORY

Junioren Kumite Jungen -55 kg

As of 4 FEB 2024

| NOC Code | Gender | Name           | Seeding |
|----------|--------|----------------|---------|
| GER      | M      | Böhm Louis     |         |
| GER      | M      | Starjacki Jona |         |

# Junioren Kumite Jungen -55 kg

Offene Landesmeisterschaft Hessen und Rheinland - Pfalz 2024, Schulstraße 2, 69509 Mörlenbach, GER

Tatami

Pool

1/1

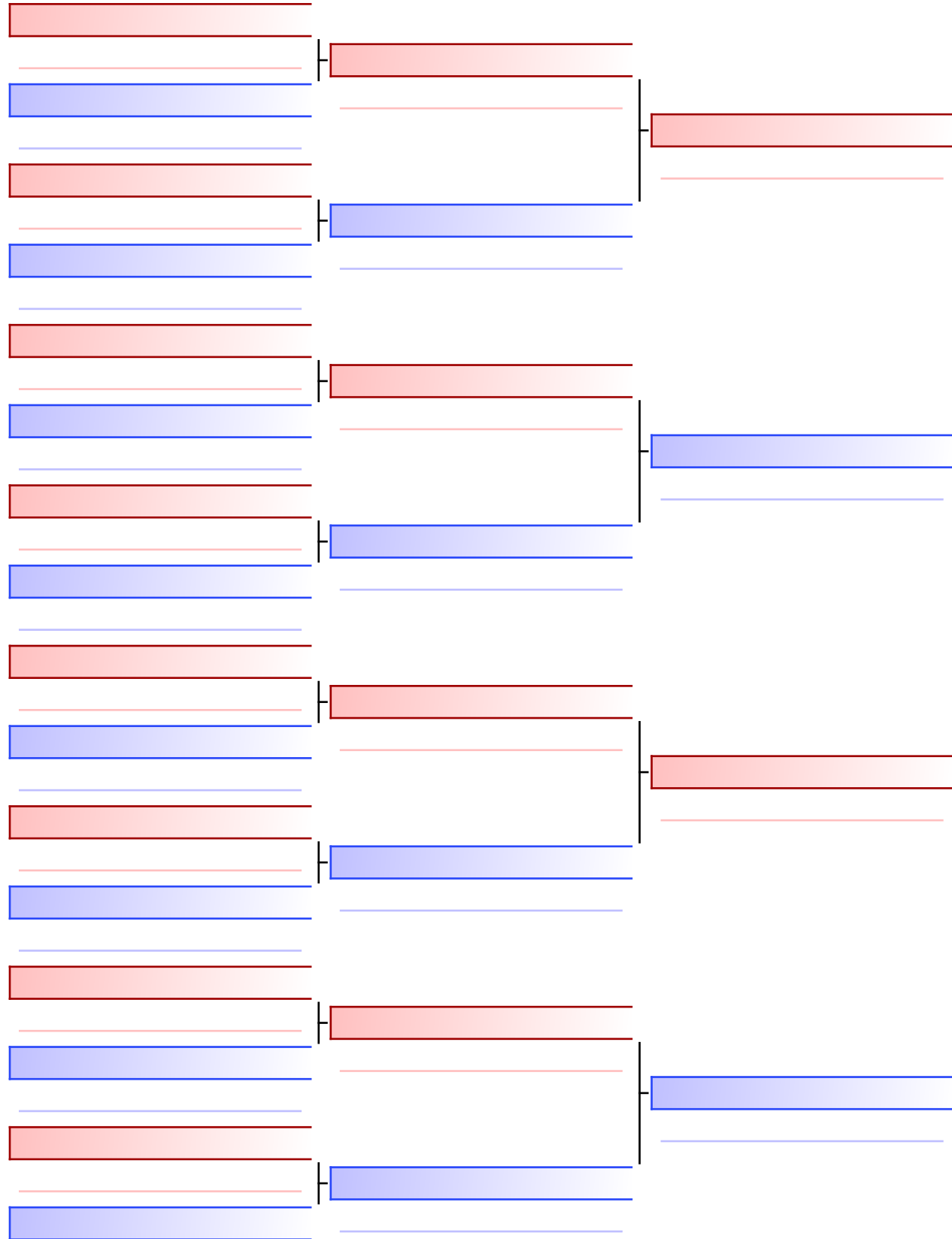

Finale

 Starijacki Jona (KDU)

1

 Starijacki Jona (KDU)

 Böhm Louis (GR Schifferstadt)

0

|                                  |
|----------------------------------|
| 1. STARIJACKI JONA (KDU)         |
| 2. BÖHM LOUIS (GR SCHIFFERSTADT) |
|                                  |
|                                  |
|                                  |
|                                  |
|                                  |

|           |  |  |  |
|-----------|--|--|--|
| Referees: |  |  |  |
|           |  |  |  |





Offene Landesmeisterschaft Hessen  
und Rheinland - Pfalz 2024 - 2024-02-03

Offizielle Ergebnisliste

| Junioren Kumite Jungen -55 kg |                |  |   |               |
|-------------------------------|----------------|--|---|---------------|
| 1                             | STARJACKI JONA | SV UNTERROT                                    |  | GER - GERMANY |
| 2                             | BÖHM LOUIS     | GOJU-RYU<br>KARATEVEREIN<br>SCHIFFERSTADT E.V. |  | GER - GERMANY |



# JUNIOREN KUMITE JUNGEN -61 kg



# Offene Landesmeisterschaft Hessen und Rheinland -..

## ENTRIES BY WEIGHT CATEGORY

Junioren Kumite Jungen -61 kg

As of 4 FEB 2024

| NOC Code | Gender | Name          | Seeding |
|----------|--------|---------------|---------|
| GER      | M      | Bruno Gabriel |         |
| GER      | M      | Knaus Devin   |         |

# Junioren Kumite Jungen -61 kg

Offene Landesmeisterschaft Hessen und Rheinland - Pfalz 2024, Schulstraße 2, 69509 Mörlenbach, GER

Tatami

Pool

1/1

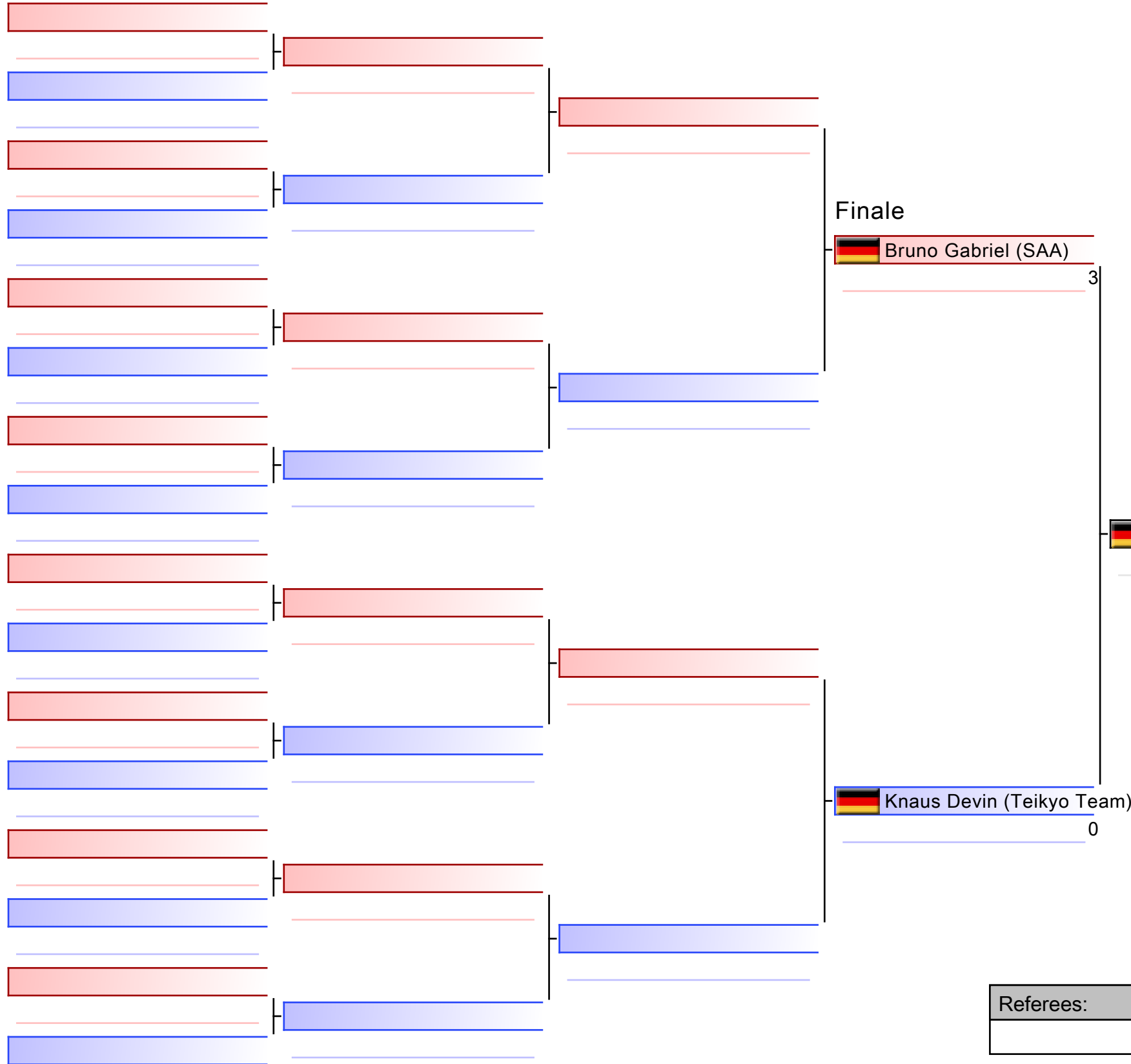

Finale

 Bruno Gabriel (SAA)  
3

 Bruno Gabriel (SAA)

 Knaus Devin (Teikyo Team)  
0

|                              |
|------------------------------|
| 1. BRUNO GABRIEL (SAA)       |
| 2. KNAUS DEVIN (TEIKYO TEAM) |
|                              |
|                              |
|                              |
|                              |
|                              |
|                              |

|           |  |  |  |
|-----------|--|--|--|
| Referees: |  |  |  |
|           |  |  |  |



Offene Landesmeisterschaft Hessen  
und Rheinland - Pfalz 2024 - 2024-02-03

Offizielle Ergebnisliste

| Junioren Kumite Jungen -61 kg |               |   |   |               |
|-------------------------------|---------------|---|---|---------------|
| 1                             | BRUNO GABRIEL | SAARLÄNDISCHER<br>KARATE- VERBAND<br>E.V. |  | GER - GERMANY |
| 2                             | KNAUS DEVIN   | TEIKYO KARATE<br>TEAM E.V.                |  | GER - GERMANY |



# JUNIOREN KUMITE JUNGEN -68 K



# Offene Landesmeisterschaft Hessen und Rheinland -..

## ENTRIES BY WEIGHT CATEGORY

Junioren Kumite Jungen -68 kg

As of 4 FEB 2024

| NOC Code | Gender | Name                   | Seeding |
|----------|--------|------------------------|---------|
| GER      | M      | Becker Maurice         |         |
| GER      | M      | Göllinger Julien-Felix |         |
| GER      | M      | Horn Yann              |         |
| GER      | M      | Mlinaritsch Alexander  |         |
| GER      | M      | Raiswich Roman         |         |
| GER      | M      | Ruris Adrian           |         |

# Junioren Kumite Jungen -68 kg

Offene Landesmeisterschaft Hessen und Rheinland - Pfalz 2024, Schulstraße 2, 69509 Mörlenbach, GER

2024-02-03

Tatami  
1 14:40

Pool  
1/1

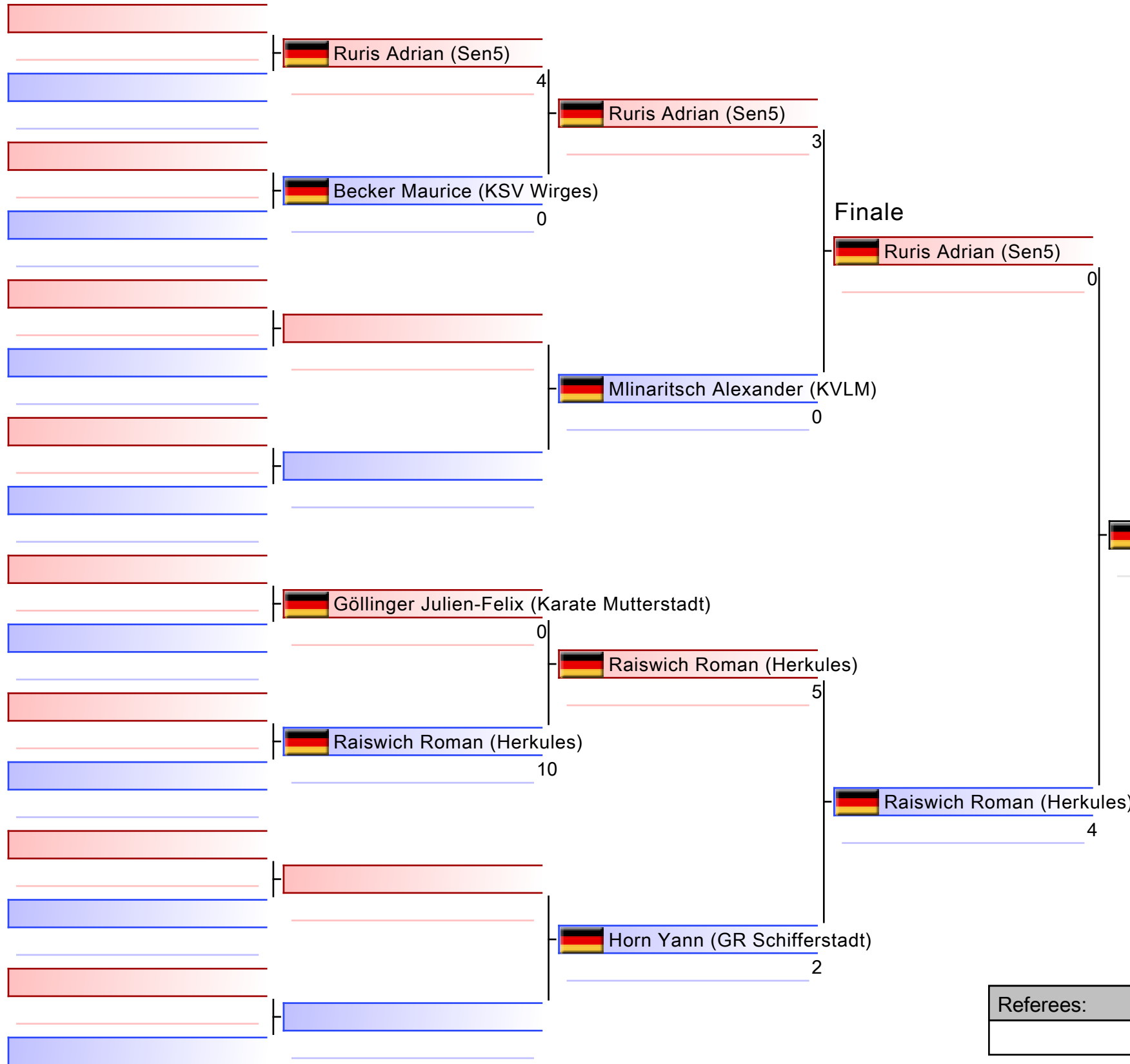

|  |
|--|
| 1. RAISWICH ROMAN (HERKULES)               |
| 2. RURIS ADRIAN (SEN5)                     |
| 3. BECKER MAURICE (KSV WIRGES)             |
| 3. HORN YANN (GR SCHIFFERSTADT)            |
| 5. MLINARITSCH ALEXANDER (KVLM)            |
| 5. GÖLLINGER JULIEN-FELIX (KARATE MUTTERS) |
|  |
|  |

|           |  |  |  |
|-----------|--|--|--|
| Referees: |  |  |  |
|           |  |  |  |



# Junioren Kumite Jungen -68 kg

Offene Landesmeisterschaft Hessen und Rheinland - Pfalz 2024

2024-02-03

Tatami  
1 15:00

Pool  
1

(c)sportdata GmbH & Co KG 2000-2024 (2024-02-04 18:16) v 10.1.0 build 1 (2024-01-30 21:40 CET) Lizenz: Online\_Event\_ID-7816\_OffeneLandesmeisterschaftHessenundRheinlandPfalz2024 (expire 2024-02-18)

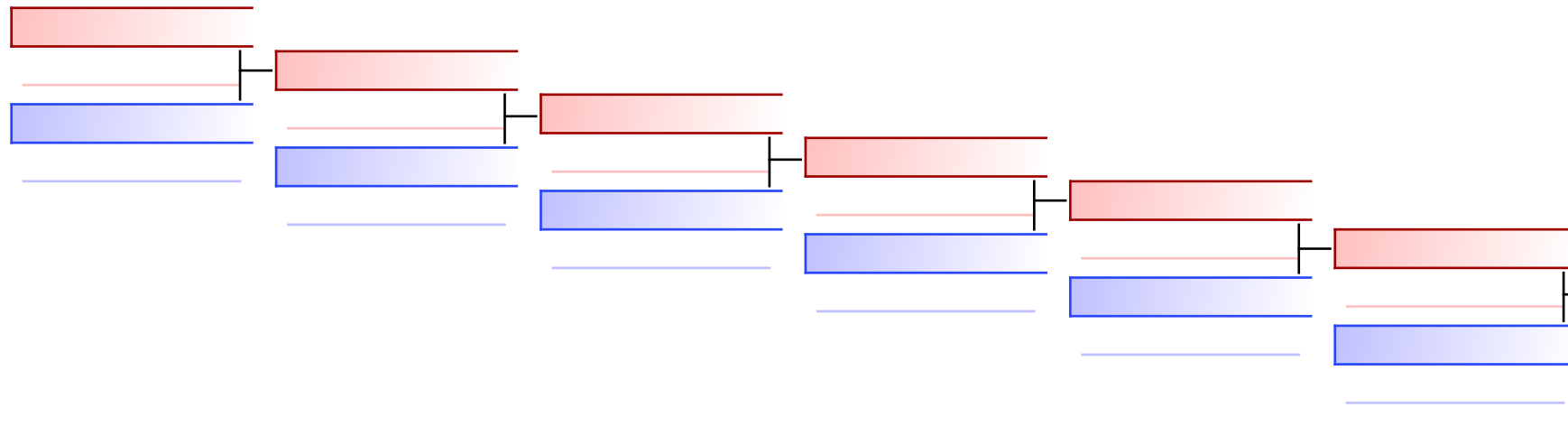

Becker Maurice (KSV Wirges) 3  
Mlinaritsch Alexander (KVLM) 0

## TROSTRUNDE: (1)

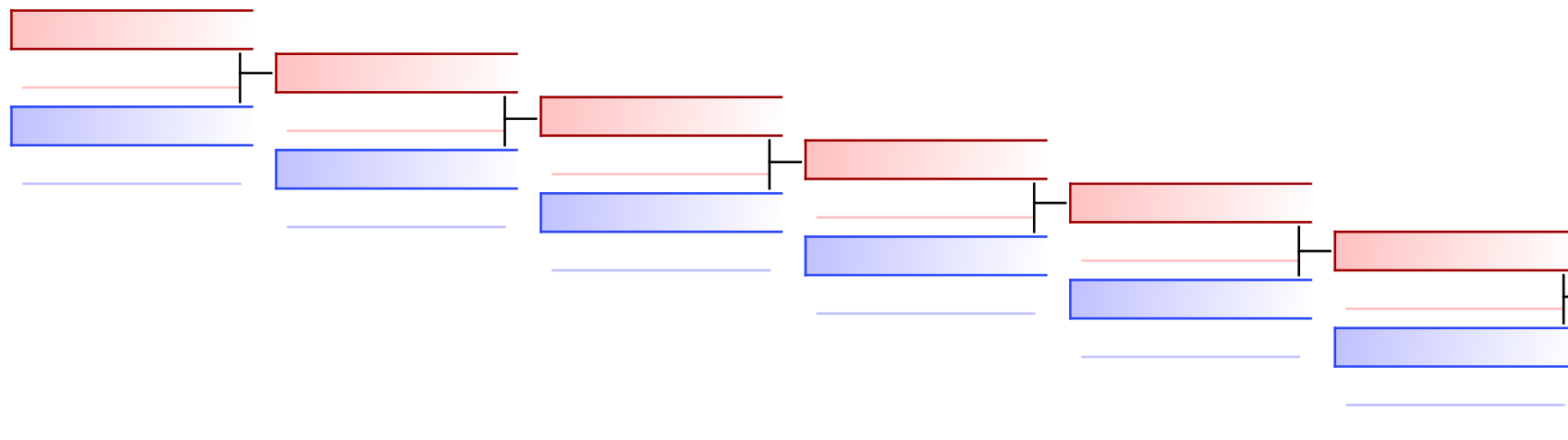

Göllinger Julien-Felix (Karate Mutterstadt) 0  
Horn Yann (GR Schifferstadt) 3

|           |  |  |  |  |  |  |  |
|-----------|--|--|--|--|--|--|--|
| Referees: |  |  |  |  |  |  |  |
|-----------|--|--|--|--|--|--|--|



Offene Landesmeisterschaft Hessen  
und Rheinland - Pfalz 2024 - 2024-02-03

Offizielle Ergebnisliste

| Junioren Kumite Jungen -68 kg |                        |  |   |               |  |
|-------------------------------|------------------------|--|---|---------------|--|
| 1                             | RAISWICH ROMAN         | SV HERKULES 01<br>KASSEL E.V.                  |  | GER - GERMANY |  |
| 2                             | RURIS ADRIAN           | SEN5 KARATE<br>VEREIN E.V.                     |  | GER - GERMANY |  |
| 3                             | BECKER MAURICE         | KARATE SPORT<br>VEREIN WIRGES E.V.             |  | GER - GERMANY |  |
| 3                             | HORN YANN              | GOJU-RYU<br>KARATEVEREIN<br>SCHIFFERSTADT E.V. |  | GER - GERMANY |  |
| 5                             | MLINARITSCH ALEXANDER  | KV LIMBURG                                     |  | GER - GERMANY |  |
| 5                             | GÖLLINGER JULIEN-FELIX | KARATE<br>MUTTERSTADT                          |  | GER - GERMANY |  |

# JUNIOREN KUMITE JUNGEN -76 kg



# Offene Landesmeisterschaft Hessen und Rheinland -..

## ENTRIES BY WEIGHT CATEGORY

Junioren Kumite Jungen -76 kg

As of 4 FEB 2024

| NOC Code | Gender | Name               | Seeding |
|----------|--------|--------------------|---------|
| GER      | M      | Becker Maximilian  |         |
| GER      | M      | Claus Bastian      |         |
| GER      | M      | Elenberg Alexander |         |
| GER      | M      | Mattheis Raphael   |         |
| GER      | M      | Tamang Cosimo      |         |

# Junioren Kumite Jungen -76 kg

Offene Landesmeisterschaft Hessen und Rheinland - Pfalz 2024, Schulstraße 2, 69509 Mörlenbach, GER

2024-02-03

Tatami

5 14:50

Pool

1/1

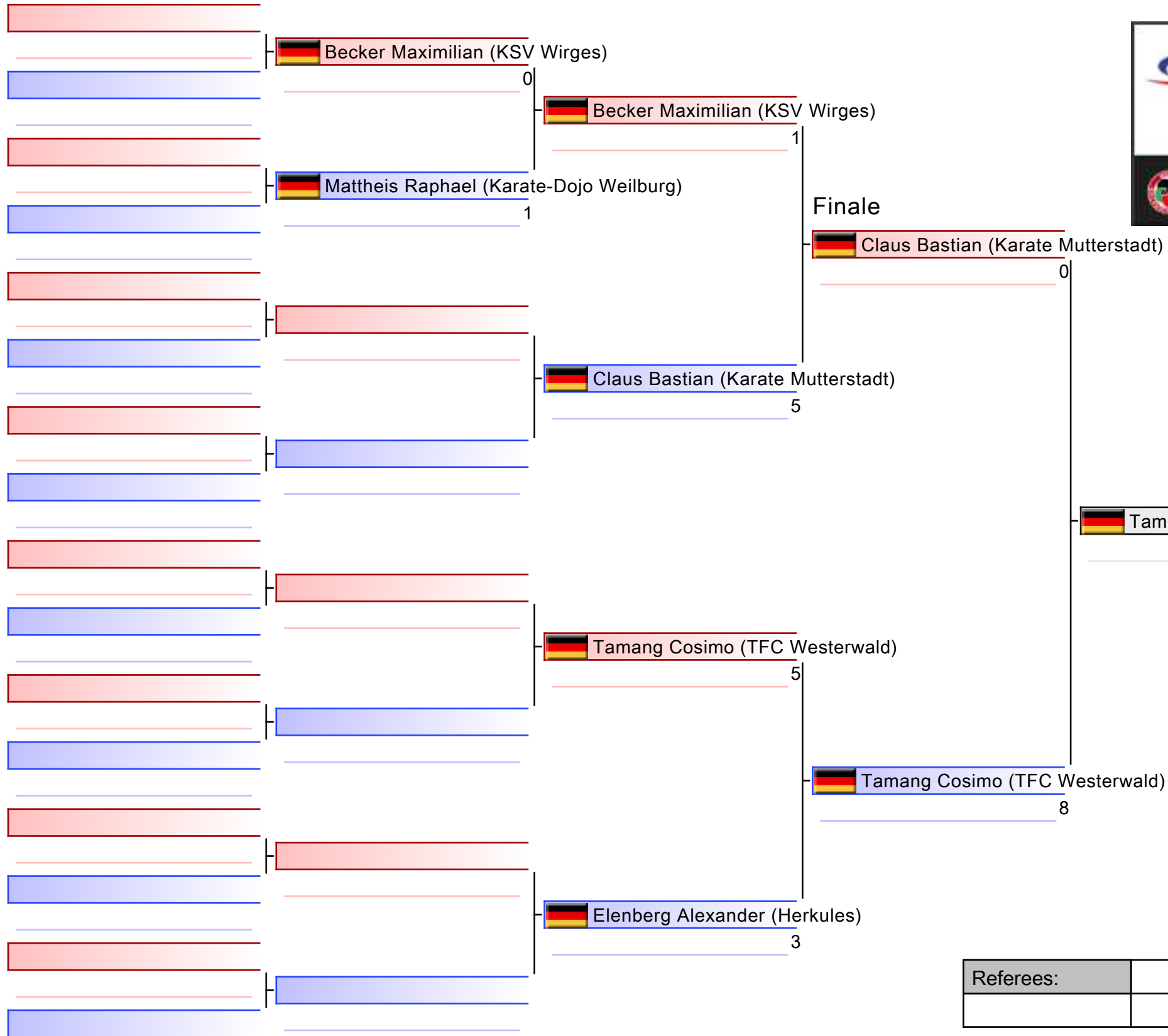

|                                       |
|---------------------------------------|
| 1. TAMANG COSIMO (TFC WESTERWALD)     |
| 2. CLAUD BASTIAN (KARATE MUTTERSTADT) |
| 3. BECKER MAXIMILIAN (KSV WIRGES)     |
| 3. ELENBERG ALEXANDER (HERKULES)      |
|                                       |
|                                       |
|                                       |

|           |  |  |  |
|-----------|--|--|--|
| Referees: |  |  |  |
|           |  |  |  |

# Junioren Kumite Jungen -76 kg

Offene Landesmeisterschaft Hessen und Rheinland - Pfalz 2024

2024-02-03

Tatami  
5 15:05

Pool  
1

(c)sportdata GmbH & Co KG 2000-2024 (2024-02-04 18:16) v 10.1.0 build 1 (2024-01-30 21:40 CET) Lizenz: Online\_Event\_ID-7816\_OffeneLandesmeisterschaftHessenundRheinlandPfalz2024 (expire 2024-02-18)

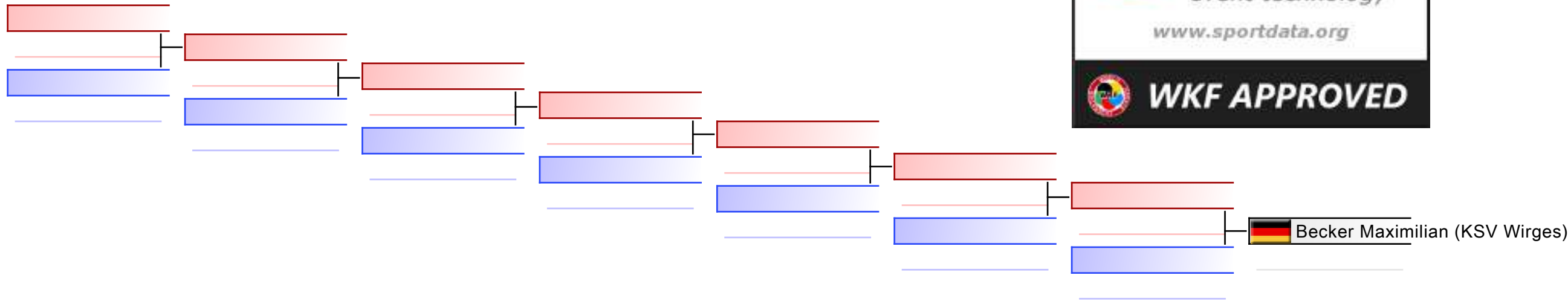

## TROSTRUNDE: (1)

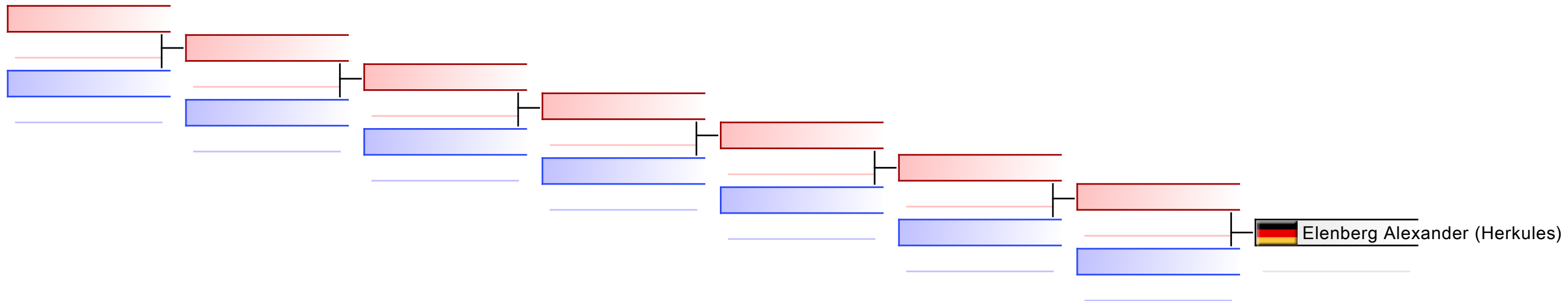

|           |  |  |  |  |  |  |  |
|-----------|--|--|--|--|--|--|--|
| Referees: |  |  |  |  |  |  |  |
|-----------|--|--|--|--|--|--|--|



Offene Landesmeisterschaft Hessen  
und Rheinland - Pfalz 2024 - 2024-02-03

Offizielle Ergebnisliste

| Junioren Kumite Jungen -76 kg |                    |                                    |   |               |  |
|-------------------------------|--------------------|------------------------------------|---|---------------|--|
| 1                             | TAMANG COSIMO      | TEAM FIGHTCLUB<br>WESTERWALD       |  | GER - GERMANY |  |
| 2                             | CLAUS BASTIAN      | KARATE<br>MUTTERSTADT              |  | GER - GERMANY |  |
| 3                             | BECKER MAXIMILIAN  | KARATE SPORT<br>VEREIN WIRGES E.V. |  | GER - GERMANY |  |
| 3                             | ELENBERG ALEXANDER | SV HERKULES 01<br>KASSEL E.V.      |  | GER - GERMANY |  |



JUNIOREN KUMITE MÄDCHEN +6  
KG





# Offene Landesmeisterschaft Hessen und Rheinland -..

## ENTRIES BY WEIGHT CATEGORY

Junioren Kumite Mädchen +66 kg

As of 4 FEB 2024

| NOC Code | Gender | Name           | Seeding |
|----------|--------|----------------|---------|
| GER      | F      | Palazi Xenia   |         |
| GER      | F      | Rath Anastasia |         |

# Junioren Kumite Mädchen +66 kg

Offene Landesmeisterschaft Hessen und Rheinland - Pfalz 2024, Schulstraße 2, 69509 Mörlenbach, GER

Tatami

Pool

1/1

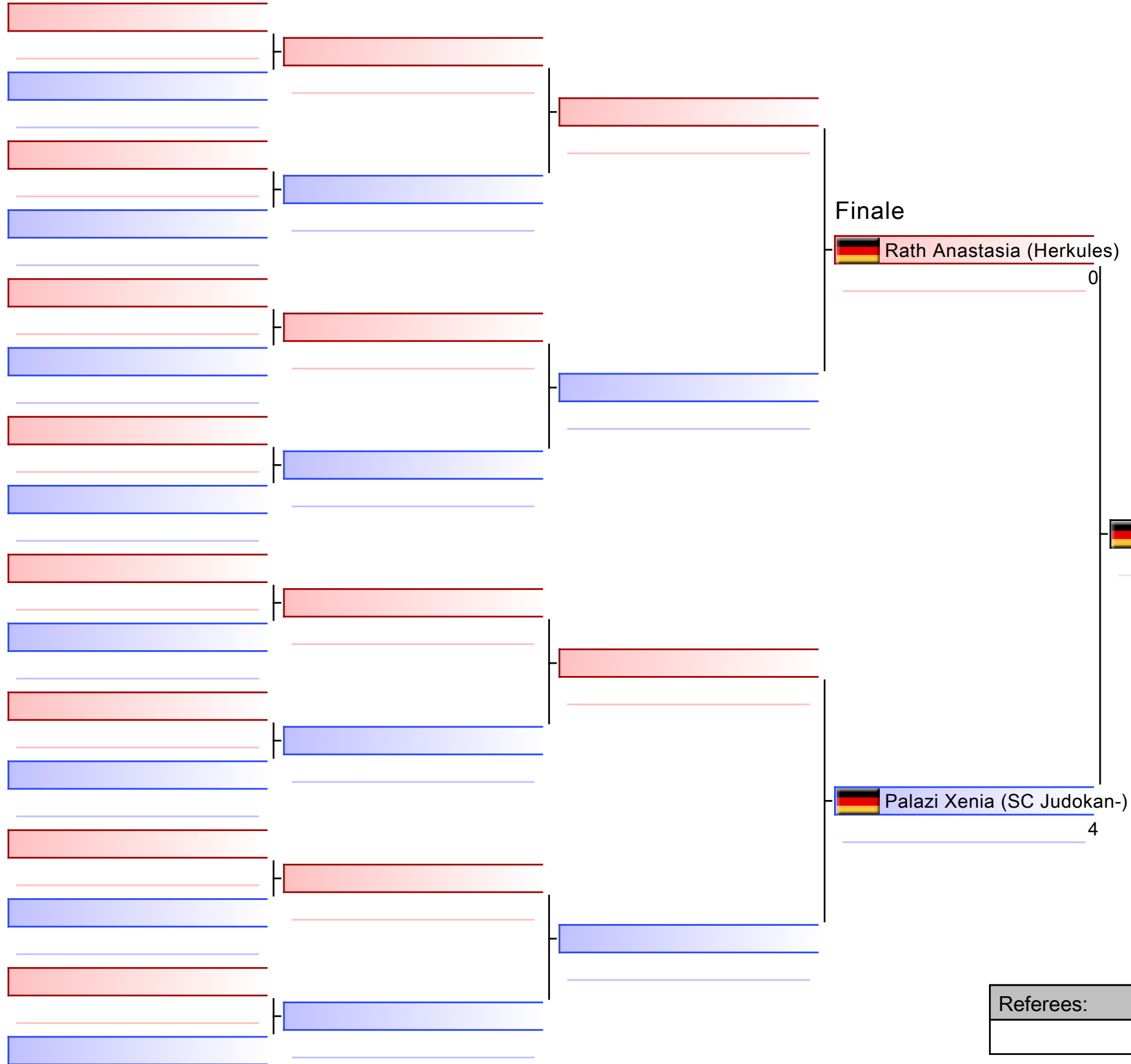

|                               |
|-------------------------------|
| 1. PALAZI XENIA (SC JUDOKAN-) |
| 2. RATH ANASTASIA (HERKULES)  |
|                               |
|                               |
|                               |
|                               |
|                               |

|           |  |  |  |
|-----------|--|--|--|
| Referees: |  |  |  |
|           |  |  |  |



Offene Landesmeisterschaft Hessen  
und Rheinland - Pfalz 2024 - 2024-02-03

Offizielle Ergebnisliste

| Junioren Kumite Mädchen +66 kg |                |                               |   |               |
|--------------------------------|----------------|-------------------------------|---|---------------|
| 1                              | PALAZI XENIA   | SC JUDOKAN E.V.               |  | GER - GERMANY |
| 2                              | RATH ANASTASIA | SV HERKULES 01<br>KASSEL E.V. |  | GER - GERMANY |

JUNIOREN KUMITE MÄDCHEN -66  
48 KG



# Offene Landesmeisterschaft Hessen und Rheinland -..

## ENTRIES BY WEIGHT CATEGORY

Juniorinnen Kumite Mädchen -66/-48 kg

As of 4 FEB 2024

| NOC Code | Gender | Name                | Seeding |
|----------|--------|---------------------|---------|
| GER      | F      | Hering Alia         |         |
| GER      | F      | Janoscheck Carlotta |         |

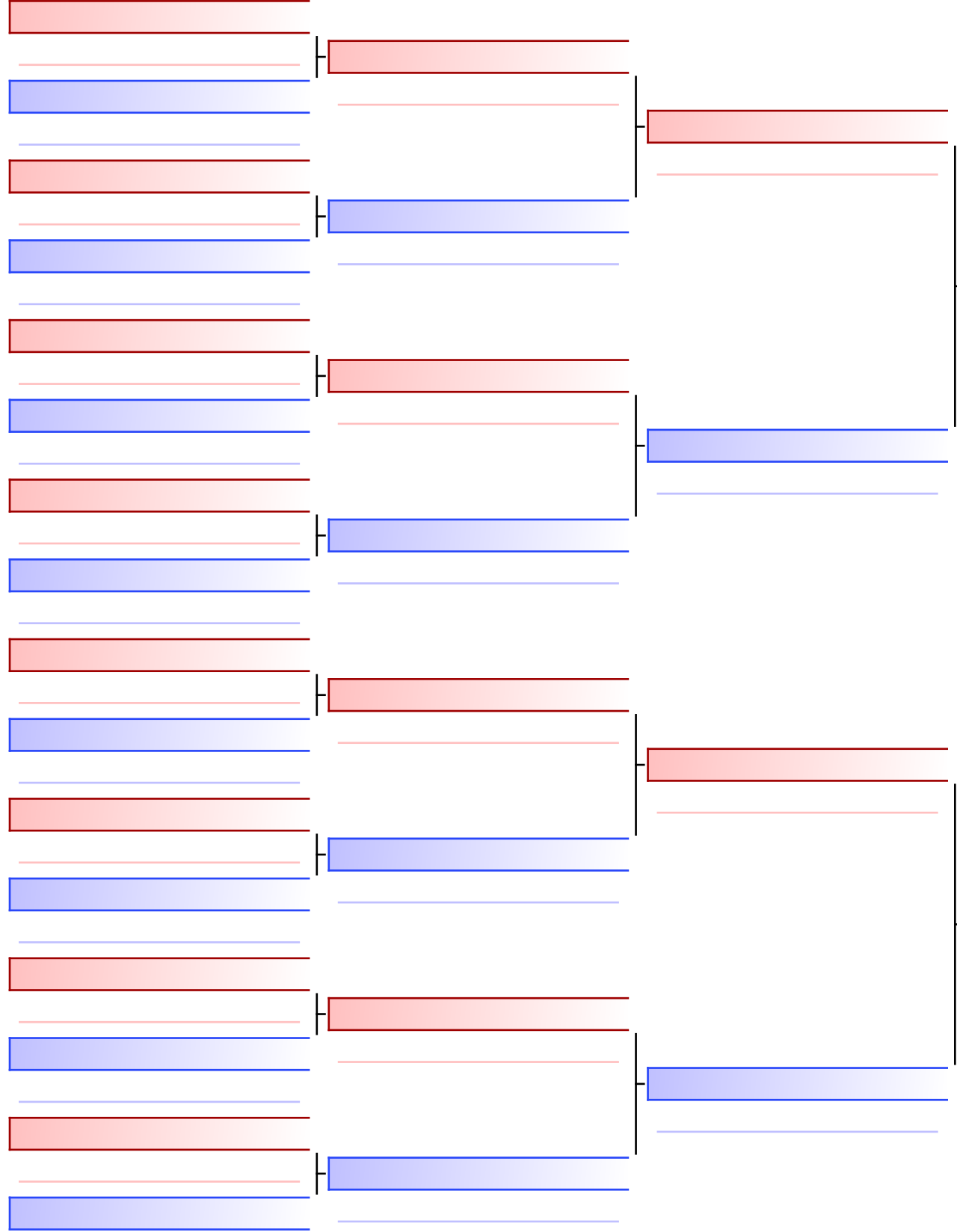

Finale

Janoscheck Carlotta (SAA)

0

Hering Alia (TFC Westerwald)

Hering Alia (TFC Westerwald)

4

|                                 |
|---------------------------------|
| 1. HERING ALIA (TFC WESTERWALD) |
| 2. JANOSCHECK CARLOTTA (SAA)    |
|                                 |
|                                 |
|                                 |
|                                 |
|                                 |

|           |  |  |  |
|-----------|--|--|--|
| Referees: |  |  |  |
|           |  |  |  |



Offene Landesmeisterschaft Hessen  
und Rheinland - Pfalz 2024 - 2024-02-03

Offizielle Ergebnisliste

| Junioren Kumite Mädchen -66/-48 kg |                     |   |   |               |
|------------------------------------|---------------------|---|---|---------------|
| 1                                  | HERING ALIA         | TEAM FIGHTCLUB<br>WESTERWALD              |  | GER - GERMANY |
| 2                                  | JANOSCHECK CARLOTTA | SAARLÄNDISCHER<br>KARATE- VERBAND<br>E.V. |  | GER - GERMANY |

# JUNIOREN KUMITE TEAM JUNGE





# Offene Landesmeisterschaft Hessen und Rheinland -..

## ENTRIES BY WEIGHT CATEGORY

### Junioren Kumite Team Jungen

As of 4 FEB 2024

| NOC Code | Gender | Name               | Seeding |
|----------|--------|--------------------|---------|
| GER      | M      | Becker Maurice     |         |
| GER      | M      | Becker Maximilian  |         |
| GER      | M      | Claus Bastian      |         |
| GER      | M      | Elenberg Alexander |         |
| GER      | M      | Glowniewski Jeremy |         |
| GER      | M      | Gumpelstetter Timo |         |
| GER      | M      | Göllinger Julien   |         |
| GER      | M      | Raiswich Roman     |         |
| GER      | M      | Rath Konstantin    |         |
| GER      | M      | Ridiger Eric       |         |
| GER      | M      | Tamang Cosimo      |         |

# Junioren Kumite Team Jungen

Offene Landesmeisterschaft Hessen und Rheinland - Pfalz 2024, Schulstraße 2, 69509 Mörlenbach, GER

2024-02-03

Tatami  
2 15:20

Pool  
1/1

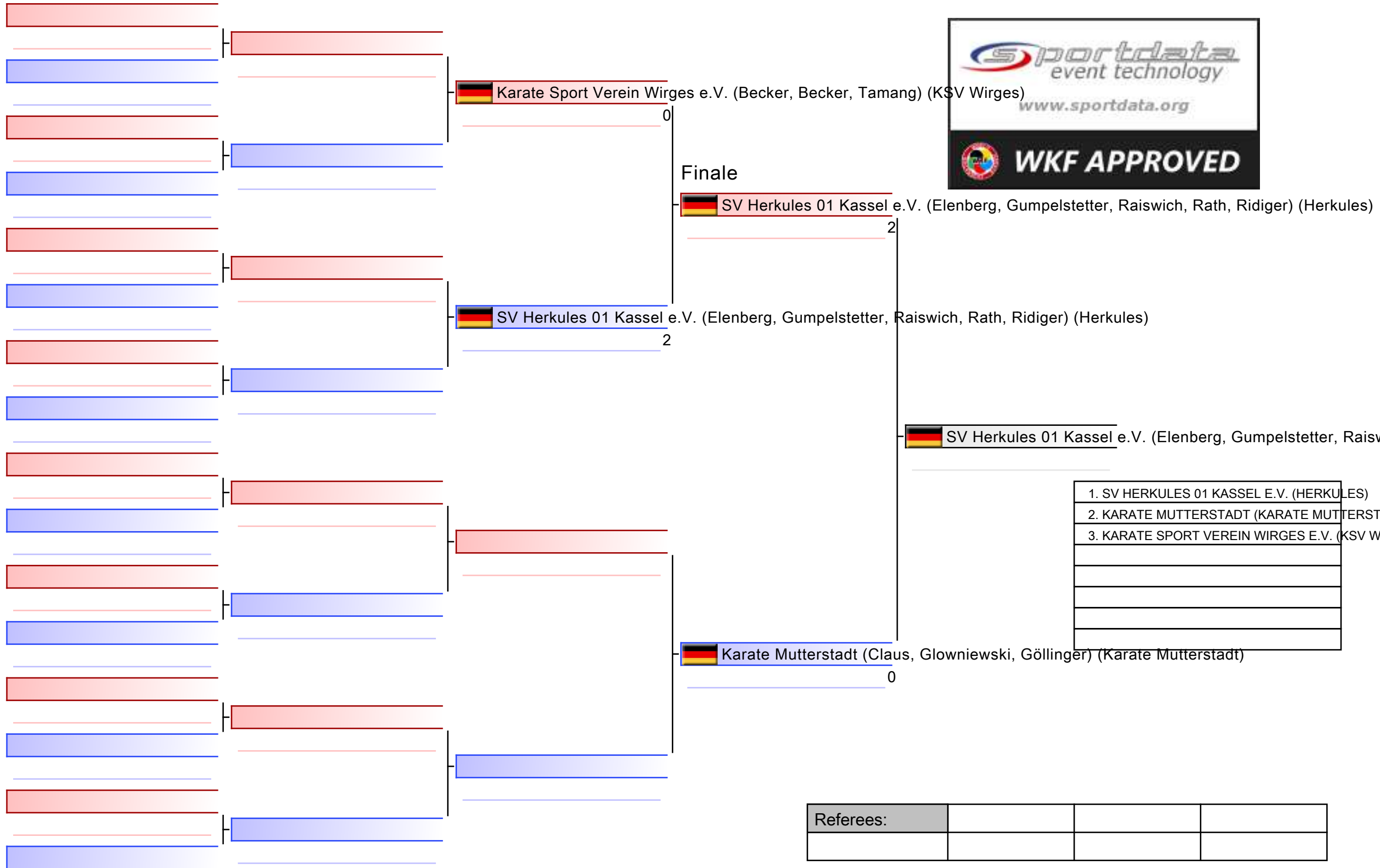

# Junioren Kumite Team Jungen

Offene Landesmeisterschaft Hessen und Rheinland - Pfalz 2024

Tatami

Pool

1

(c)sportdata GmbH & Co KG 2000-2024 (2024-02-04 18:16) v 10.1.0 build 1 (2024-01-30 21:40 CET) Lizenz: Online\_Event\_ID-7816\_OffeneLandesmeisterschaftHessenundRheinlandPfalz2024 (expire 2024-02-18)

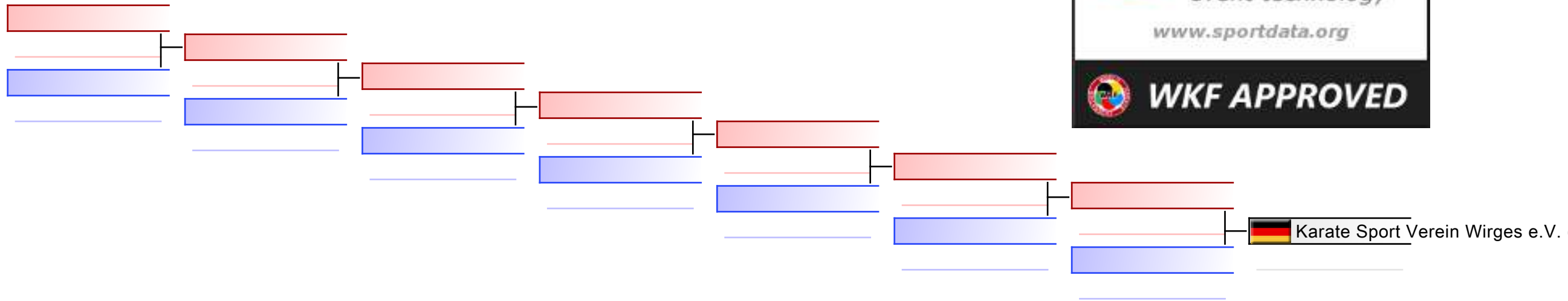

## TROSTRUNDE: (1)

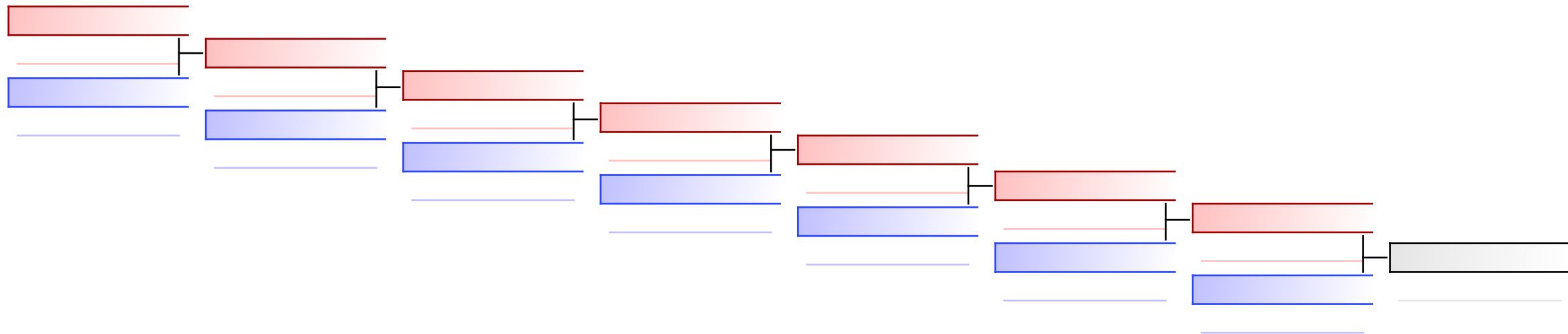

|           |  |  |  |  |  |  |  |
|-----------|--|--|--|--|--|--|--|
| Referees: |  |  |  |  |  |  |  |
|-----------|--|--|--|--|--|--|--|



Offene Landesmeisterschaft Hessen  
und Rheinland - Pfalz 2024 - 2024-02-03

Offizielle Ergebnisliste

| Junioren Kumite Team Jungen |   |                                    |   |               |
|-----------------------------|---|------------------------------------|---|---------------|
| 1                           | SV HERKULES 01 KASSEL E.V.<br>- ELENBERG ALEXANDER<br>- GUMPELSTETTER TIMO<br>- RAISWICH ROMAN<br>- RATH KONSTANTIN<br>- RIDIGER ERIC | SV HERKULES 01<br>KASSEL E.V.      |  | GER - GERMANY |
| 2                           | KARATE MUTTERSTADT<br>- CLAUS BASTIAN<br>- GLOWNIEWSKI JEREMY<br>- GÖLLINGER JULIEN   | KARATE<br>MUTTERSTADT              |  | GER - GERMANY |
| 3                           | KARATE SPORT VEREIN<br>WIRGES E.V.<br>- BECKER MAURICE<br>- BECKER MAXIMILIAN<br>- TAMANG COSIMO                                      | KARATE SPORT<br>VEREIN WIRGES E.V. |  | GER - GERMANY |



KATA MASTERKLASSE DAMEN  
Ü30/Ü35



# Offene Landesmeisterschaft Hessen und Rheinland -..

## ENTRIES BY WEIGHT CATEGORY

### Kata Masterklasse Damen Ü30/Ü35

As of 4 FEB 2024

| NOC Code | Gender | Name              | Seeding |
|----------|--------|-------------------|---------|
| GER      | F      | Agte Sarah        |         |
| GER      | F      | Brach Livia       |         |
| GER      | F      | Laier Martina     |         |
| GER      | F      | Wallusch Patricia |         |
| GER      | F      | Zechlin Sladana   |         |

# Kata Masterklasse Damen Ü30/Ü35

Offene Landesmeisterschaft Hessen und Rheinland - Pfalz 2024, Schulstraße 2, 69509 Mörlenbach, GER

2024-02-03

Tatami  
2 11:10

Pool  
1/1

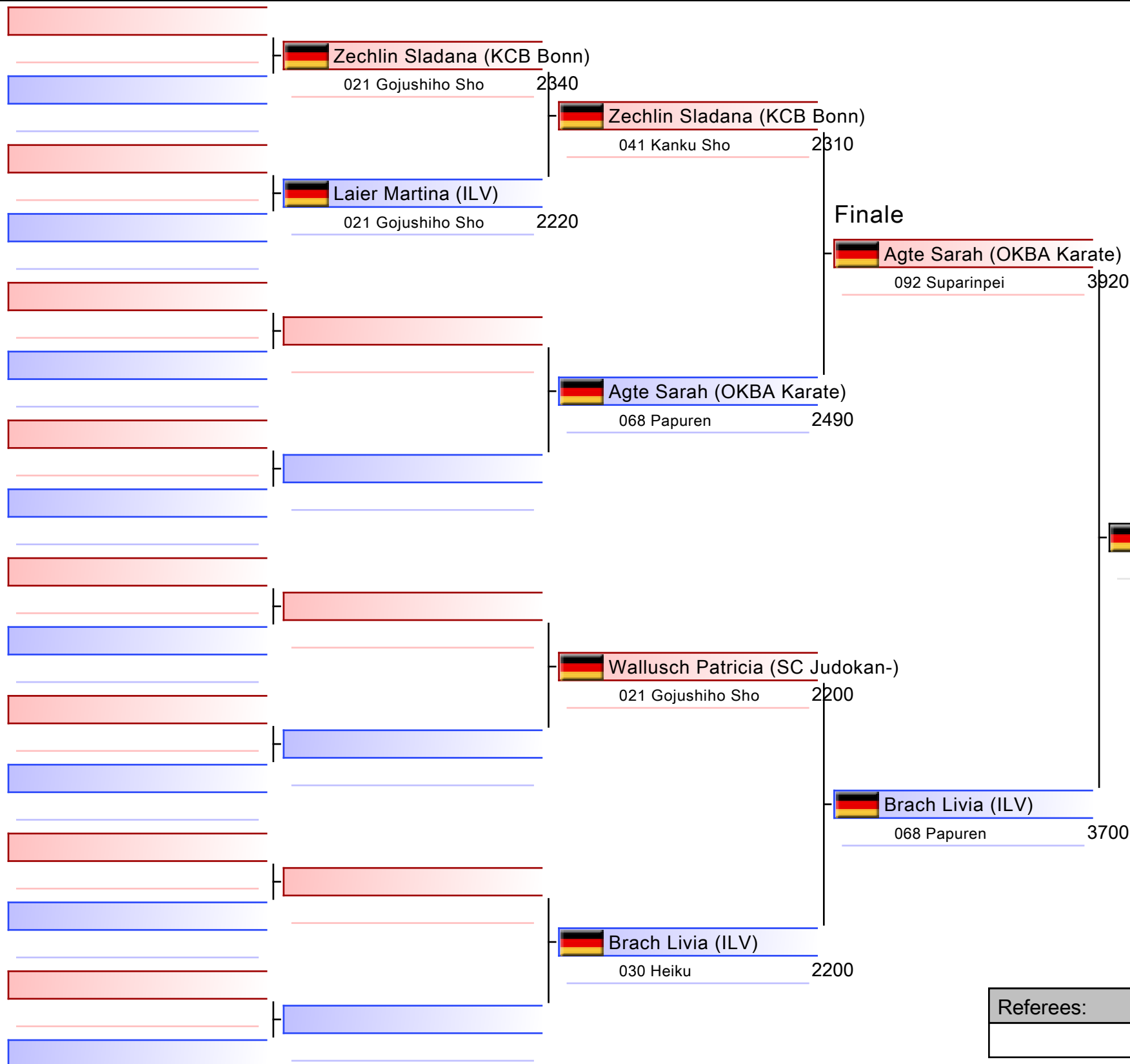

|                                    |
|------------------------------------|
| 1. AGTE SARAH (OKBA KARATE)        |
| 2. BRACH LIVIA (ILV)               |
| 3. ZECHLIN SLADANA (KCB BONN)      |
| 3. WALLUSCH PATRICIA (SC JUDOKAN-) |
|                                    |
|                                    |
|                                    |

|           |  |  |  |
|-----------|--|--|--|
| Referees: |  |  |  |
|           |  |  |  |

# Kata Masterklasse Damen Ü30/Ü35

Offene Landesmeisterschaft Hessen und Rheinland - Pfalz 2024

2024-02-03

Tatami  
2 11:25

Pool  
1

(c)sportdata GmbH & Co KG 2000-2024 (2024-02-04 18:16) v 10.1.0 build 1 (2024-01-30 21:40 CET) Lizenz: Online\_Event\_ID-7816\_OffeneLandesmeisterschaftHessenundRheinlandPfalz2024 (expire 2024-02-18)

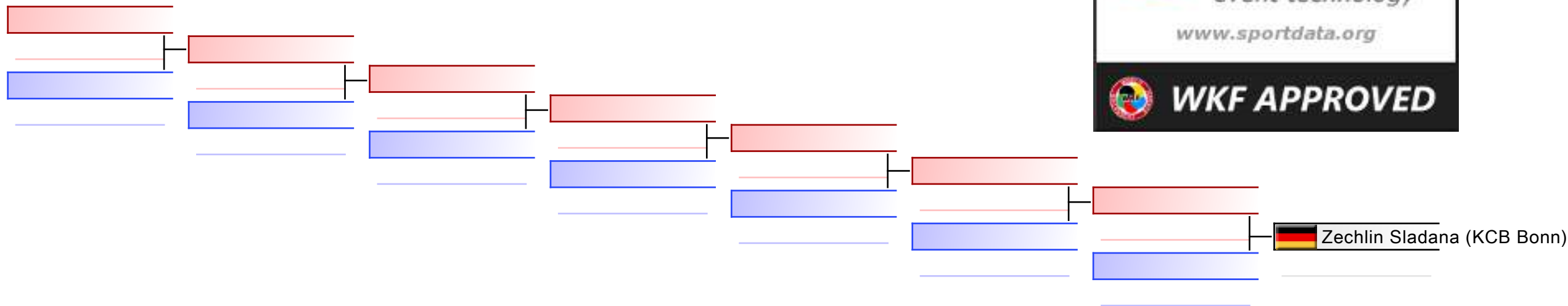

## TROSTRUNDE: (1)

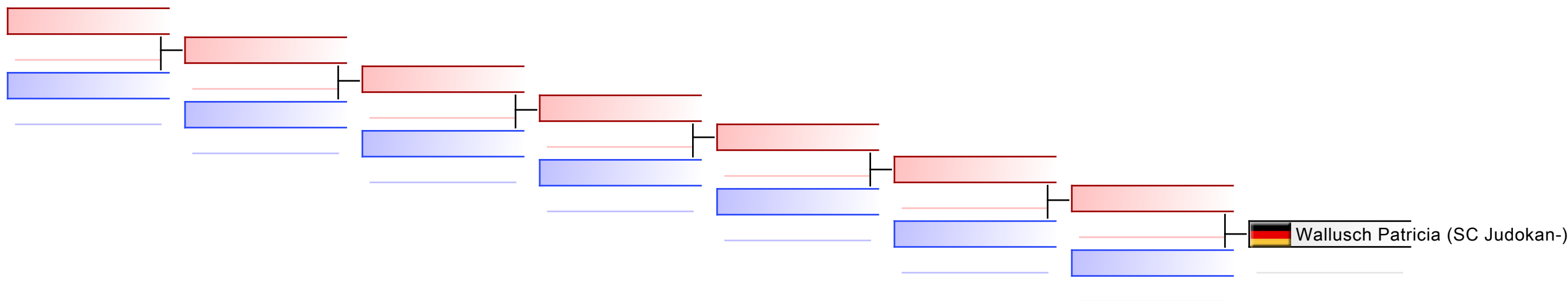

|           |  |  |  |  |  |  |  |
|-----------|--|--|--|--|--|--|--|
| Referees: |  |  |  |  |  |  |  |
|-----------|--|--|--|--|--|--|--|





Offene Landesmeisterschaft Hessen  
und Rheinland - Pfalz 2024 - 2024-02-03

Offizielle Ergebnisliste

| Kata Masterklasse Damen Ü30/Ü35 |                   |                             |   |               |
|---------------------------------|-------------------|-----------------------------|---|---------------|
| 1                               | AGTE SARAH        | SKO WISMAR E.V.             |  | GER - GERMANY |
| 2                               | BRACH LIVIA       | KARATE ILVESHEIM            |  | GER - GERMANY |
| 3                               | ZECHLIN SLADANA   | KARATE CLUB<br>BUSHIDO BONN |  | GER - GERMANY |
| 3                               | WALLUSCH PATRICIA | SC JUDOKAN E.V.             |  | GER - GERMANY |

# KATA MASTERKLASSE DAMEN Ü



# Offene Landesmeisterschaft Hessen und Rheinland -..

## ENTRIES BY WEIGHT CATEGORY

### Kata Masterklasse Damen Ü45

As of 4 FEB 2024

| NOC Code | Gender | Name            | Seeding |
|----------|--------|-----------------|---------|
| GER      | F      | Durdevic Jasna  |         |
| GER      | F      | Klaas Manuela   |         |
| GER      | F      | Maier Berenike  |         |
| GER      | F      | Roth Nadja      |         |
| GER      | F      | Steverding Sara |         |

# Kata Masterklasse Damen Ü45

Offene Landesmeisterschaft Hessen und Rheinland - Pfalz 2024, Schulstraße 2, 69509 Mörlenbach, GER

2024-02-03

Tatami  
6 11:30

Pool  
1/1

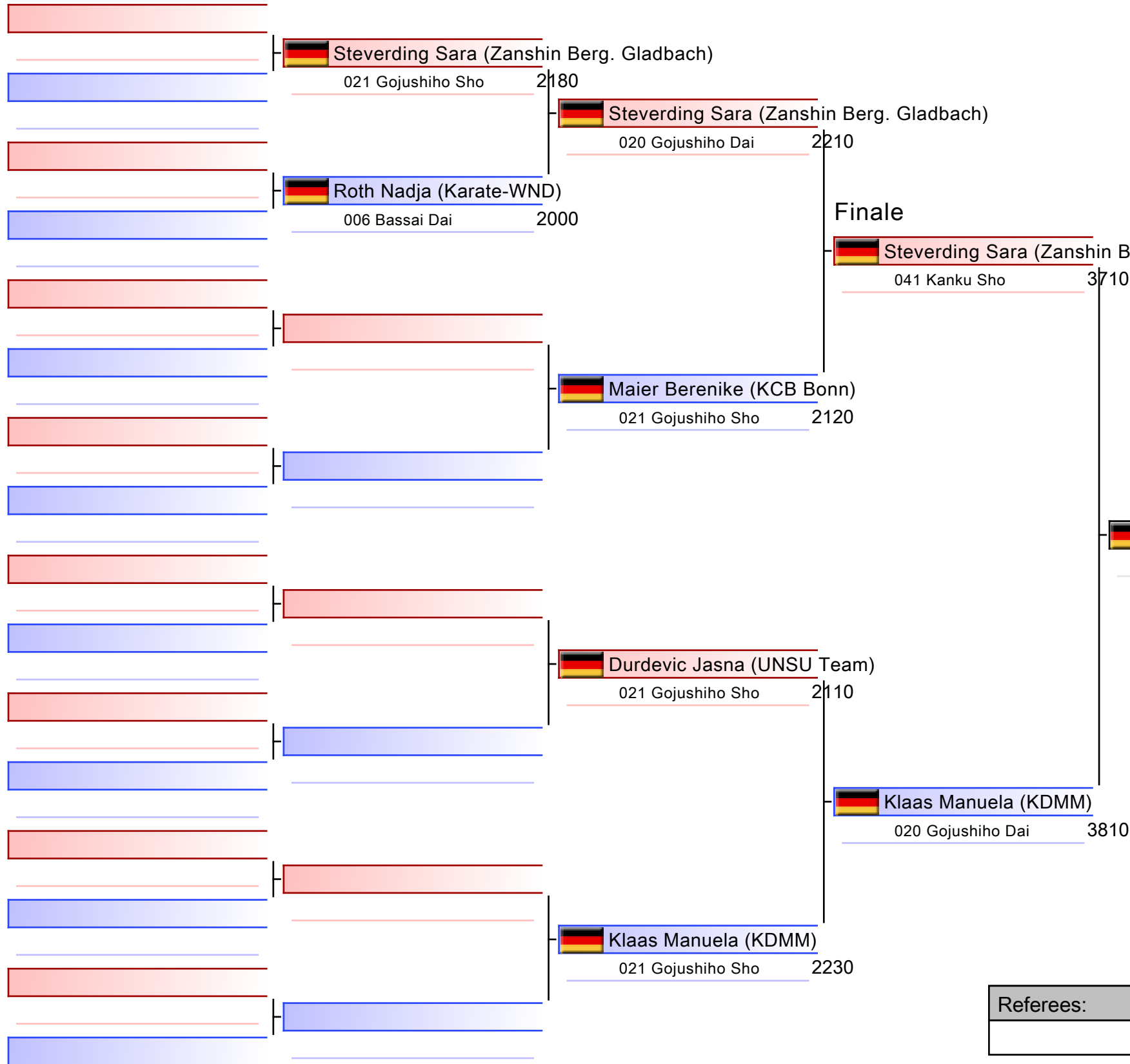

|  |
|--|
| 1. KLAAS MANUELA (KDMM)                  |
| 2. STEVERDING SARA (ZANSHIN BERG. GLADBA |
| 3. DURDEVIC JASNA (UNSU TEAM)            |
| 3. MAIER BERENIKE (KCB BONN)             |
| 5. ROTH NADJA (KARATE-WND)               |
|  |
|  |

|           |  |  |  |
|-----------|--|--|--|
| Referees: |  |  |  |
|           |  |  |  |

# Kata Masterklasse Damen Ü45

Offene Landesmeisterschaft Hessen und Rheinland - Pfalz 2024

2024-02-03

Tatami  
6 11:45

Pool  
1

(c)sportdata GmbH & Co KG 2000-2024 (2024-02-04 18:16) v 10.1.0 build 1 (2024-01-30 21:40 CET) Lizenz: Online\_Event\_ID-7816\_OffeneLandesmeisterschaftHessenundRheinlandPfalz2024 (expire 2024-02-18)

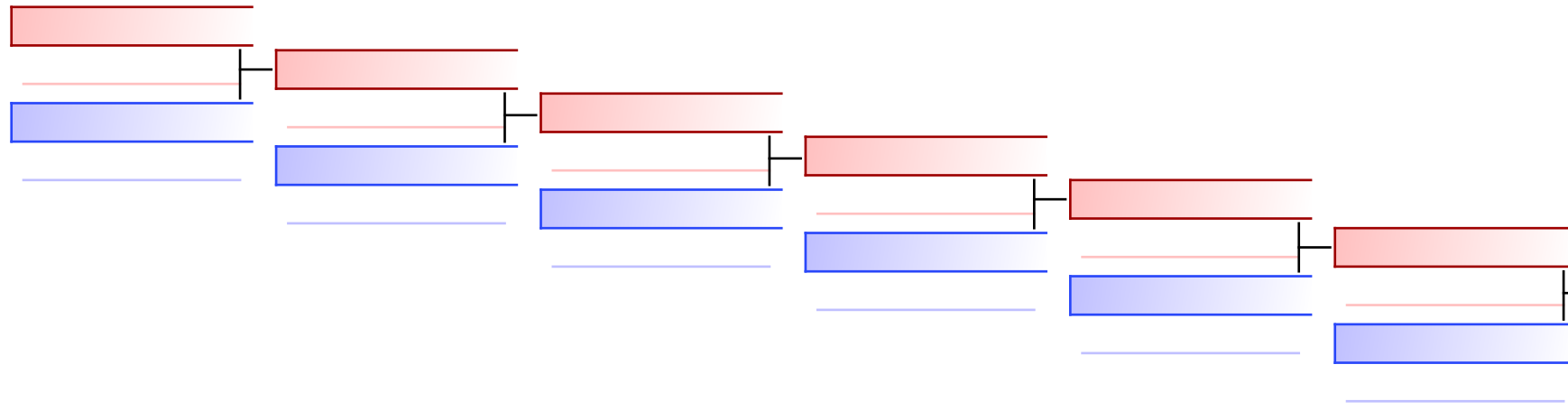

Roth Nadja (Karate-WND)  
037 Jitte | 0  
 Maier Berenike (KCB Bonn)  
 Maier Berenike (KCB Bonn)  
020 Gojushiho. 3510

## TROSTRUNDE: (1)

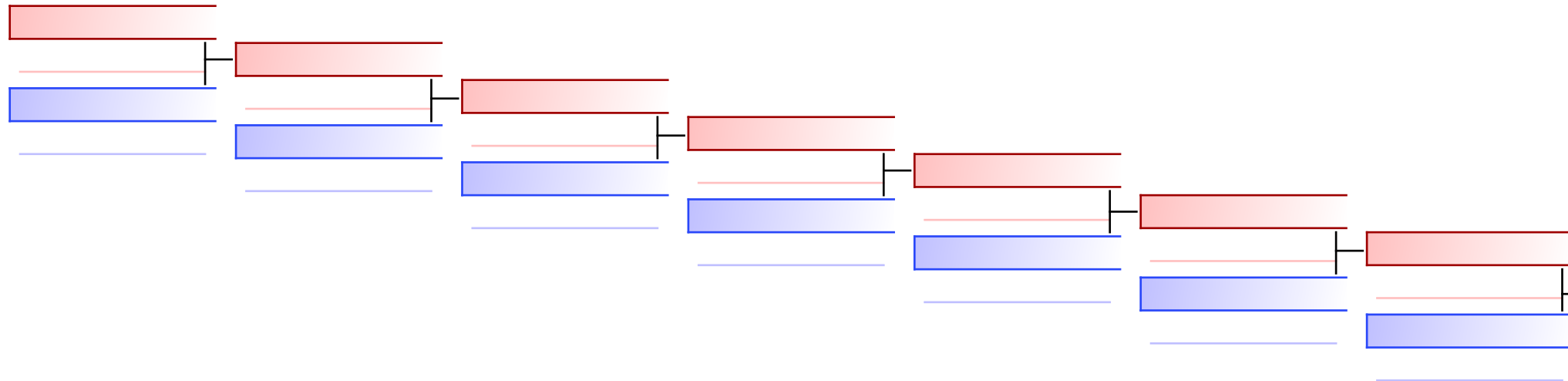





Durdevic Jasna (UNSU Team)

|           |  |  |  |  |  |  |  |
|-----------|--|--|--|--|--|--|--|
| Referees: |  |  |  |  |  |  |  |
|-----------|--|--|--|--|--|--|--|



Offene Landesmeisterschaft Hessen  
und Rheinland - Pfalz 2024 - 2024-02-03

Offizielle Ergebnisliste

| Kata Masterklasse Damen Ü45 |                 |   |   |               |  |
|-----------------------------|-----------------|---|---|---------------|--|
| 1                           | KLAAS MANUELA   | KARATE DOJO<br>MAYEN-MENDIG                 |  | GER - GERMANY |  |
| 2                           | STEVERDING SARA | KARATE ZANSHIN<br>BERGISCH<br>GLADBACH E.V. |  | GER - GERMANY |  |
| 3                           | DURDEVIC JASNA  | SV UNSU KARATE<br>MÖMLINGEN E.V.            |  | GER - GERMANY |  |
| 3                           | MAIER BERENIKE  | KARATE CLUB<br>BUSHIDO BONN                 |  | GER - GERMANY |  |
| 5                           | ROTH NADJA      | TV. ST.WENDEL-ABT<br>KARATE                 |  | GER - GERMANY |  |

# KATA MASTERKLASSE DAMEN Ü



# Offene Landesmeisterschaft Hessen und Rheinland -..

## ENTRIES BY WEIGHT CATEGORY

### Kata Masterklasse Damen Ü55

As of 4 FEB 2024

| NOC Code | Gender | Name                  | Seeding |
|----------|--------|-----------------------|---------|
| GER      | F      | Gerke-Körting Manuela |         |
| GER      | F      | Hamami Joheina        |         |
| GER      | F      | Herges Anke           |         |
| GER      | F      | Lang Monika           |         |
| GER      | F      | Schulz Elke           |         |



# Kata Masterklasse Damen Ü55

Offene Landesmeisterschaft Hessen und Rheinland - Pfalz 2024, Schulstraße 2, 69509 Mörlenbach, GER

2024-02-03

Tatami

2 10:45

Pool

1/1

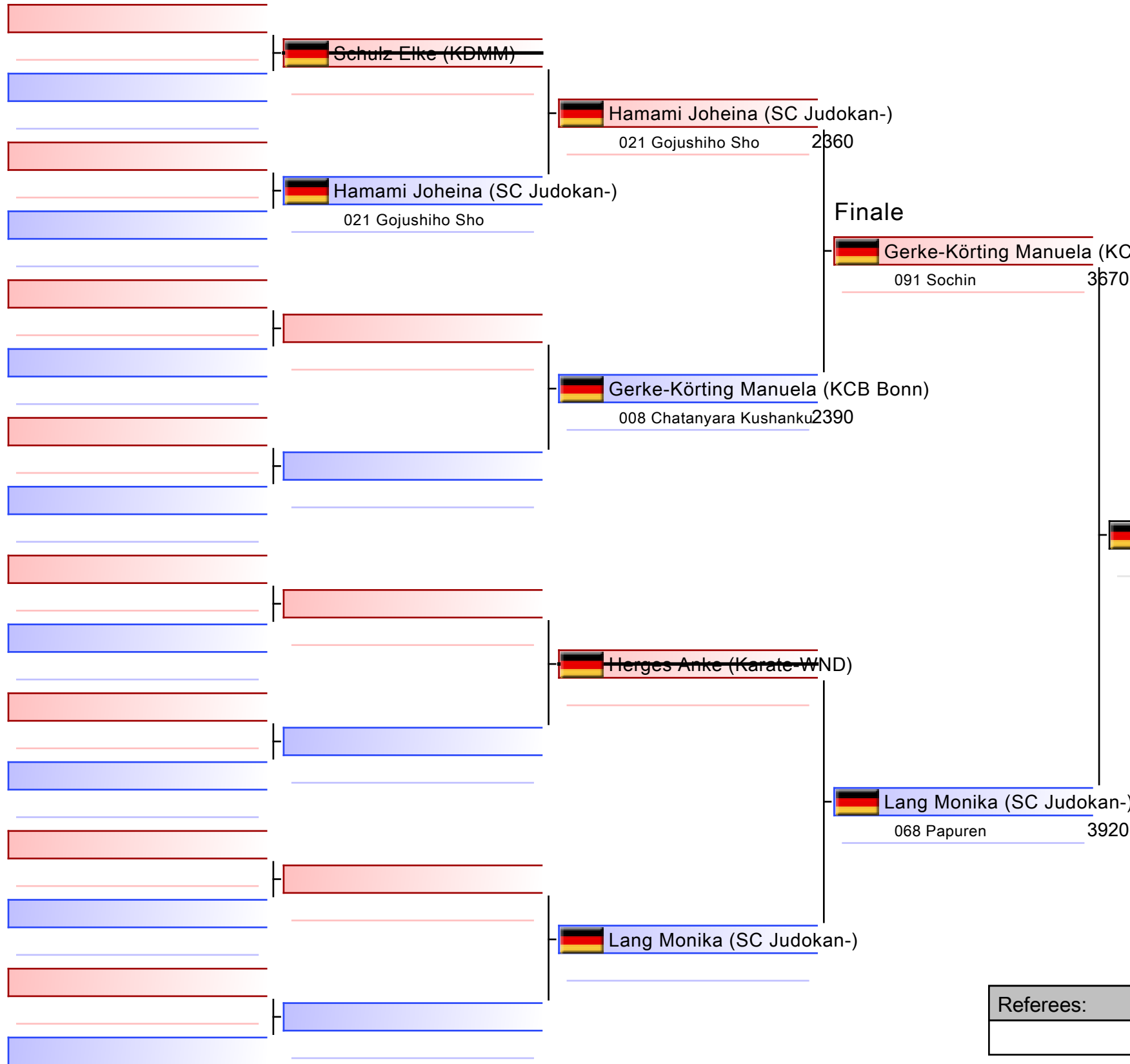

|                                     |
|-------------------------------------|
| 1. LANG MONIKA (SC JUDOKAN-)        |
| 2. GERKE-KÖRTING MANUELA (KCB BONN) |
| 3. HAMAMI JOHEINA (SC JUDOKAN-)     |
|                                     |
|                                     |
|                                     |
|                                     |

|           |  |  |  |
|-----------|--|--|--|
| Referees: |  |  |  |
|           |  |  |  |

# Kata Masterklasse Damen Ü55

Offene Landesmeisterschaft Hessen und Rheinland - Pfalz 2024

2024-02-03

Tatami

2 11:00

Pool

1

(c)sportdata GmbH & Co KG 2000-2024 (2024-02-04 18:16) v 10.1.0 build 1 (2024-01-30 21:40 CET) Lizenz: Online\_Event\_ID-7816\_OffeneLandesmeisterschaftHessenundRheinlandPfalz2024 (expire 2024-02-18)

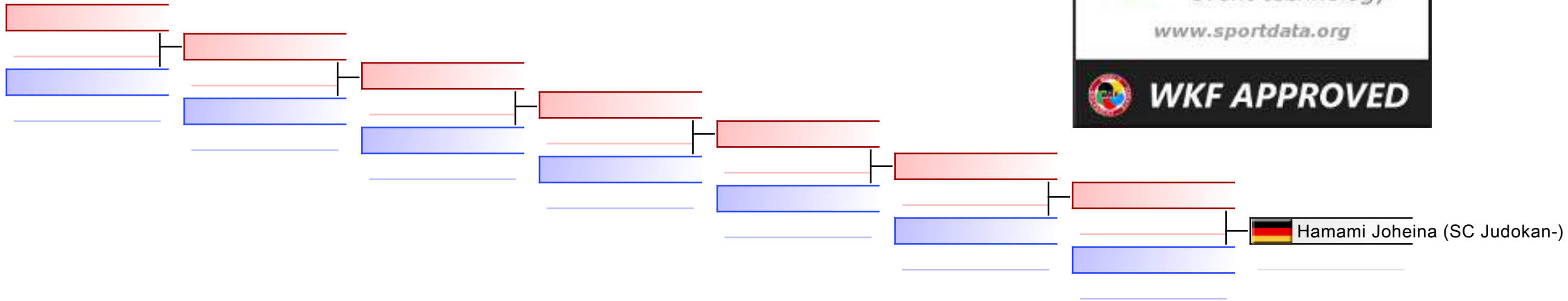

## TROSTRUNDE: (1)

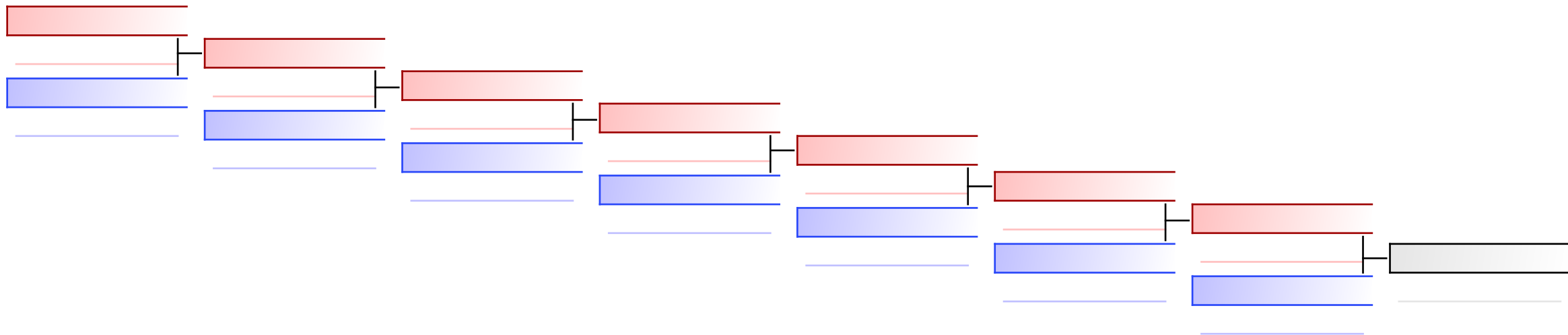

|           |  |  |  |  |  |  |  |
|-----------|--|--|--|--|--|--|--|
| Referees: |  |  |  |  |  |  |  |
|-----------|--|--|--|--|--|--|--|



Offene Landesmeisterschaft Hessen  
und Rheinland - Pfalz 2024 - 2024-02-03

Offizielle Ergebnisliste

| Kata Masterklasse Damen Ü55 |                       |                             |   |               |
|-----------------------------|-----------------------|-----------------------------|---|---------------|
| 1                           | LANG MONIKA           | SC JUDOKAN E.V.             |  | GER - GERMANY |
| 2                           | GERKE-KÖRTING MANUELA | KARATE CLUB<br>BUSHIDO BONN |  | GER - GERMANY |
| 3                           | HAMAMI JOHEINA        | SC JUDOKAN E.V.             |  | GER - GERMANY |



KATA MASTERKLASSE HERREN  
Ü30/Ü35



# Offene Landesmeisterschaft Hessen und Rheinland -..

## ENTRIES BY WEIGHT CATEGORY

### Kata Masterklasse Herren Ü30/Ü35

As of 4 FEB 2024

| NOC Code | Gender | Name           | Seeding |
|----------|--------|----------------|---------|
| GER      | M      | Brackmann Ulf  |         |
| GER      | M      | Krämer Jochen  |         |
| GER      | M      | Privitera Nico |         |

# Kata Masterklasse Herren Ü30/Ü35

Offene Landesmeisterschaft Hessen und Rheinland - Pfalz 2024, Schulstraße 2, 69509 Mörlenbach, GER

2024-02-03

Tatami

3 11:30

Pool

1/1

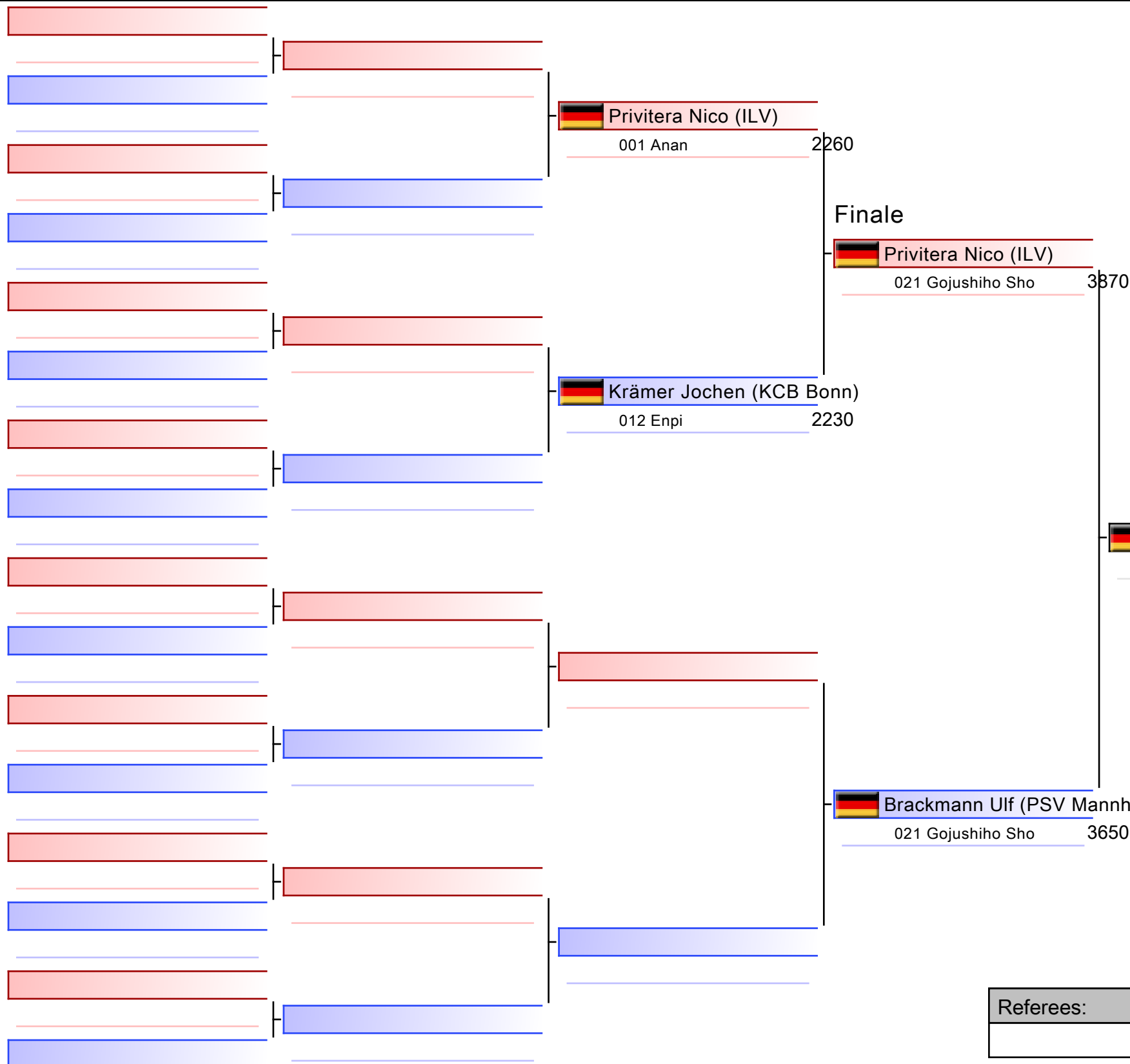

|                                      |
|--------------------------------------|
| 1. PRIVITERA NICO (ILV)              |
| 2. BRACKMANN ULF (PSV MANNHEIM E.V.) |
| 3. KRÄMER JOCHEN (KCB BONN)          |
|                                      |
|                                      |
|                                      |
|                                      |

|           |  |  |  |
|-----------|--|--|--|
| Referees: |  |  |  |
|           |  |  |  |

# Kata Masterklasse Herren Ü30/Ü35

Offene Landesmeisterschaft Hessen und Rheinland - Pfalz 2024

Tatami

Pool

1

(c)sportdata GmbH & Co KG 2000-2024 (2024-02-04 18:16) v 10.1.0 build 1 (2024-01-30 21:40 CET) Lizenz: Online\_Event\_ID-7816\_OffeneLandesmeisterschaftHessenundRheinlandPfalz2024 (expire 2024-02-18)

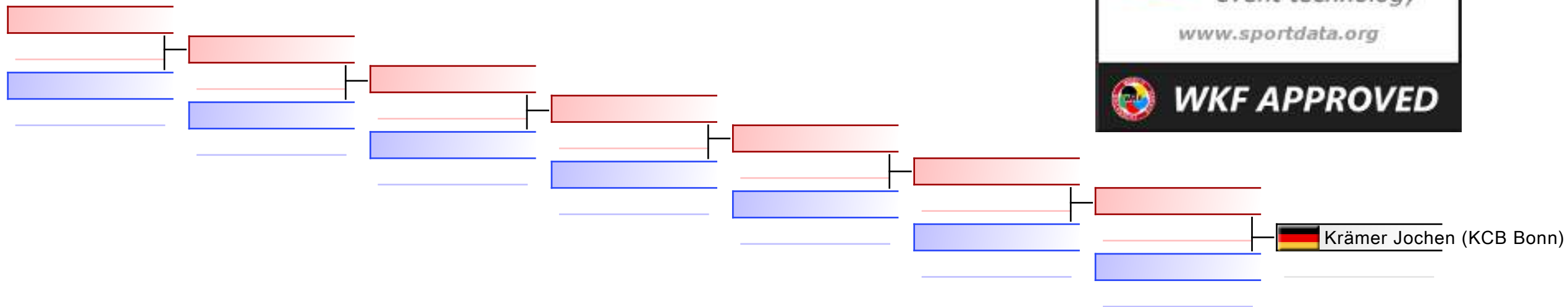

## TROSTRUNDE: (1)

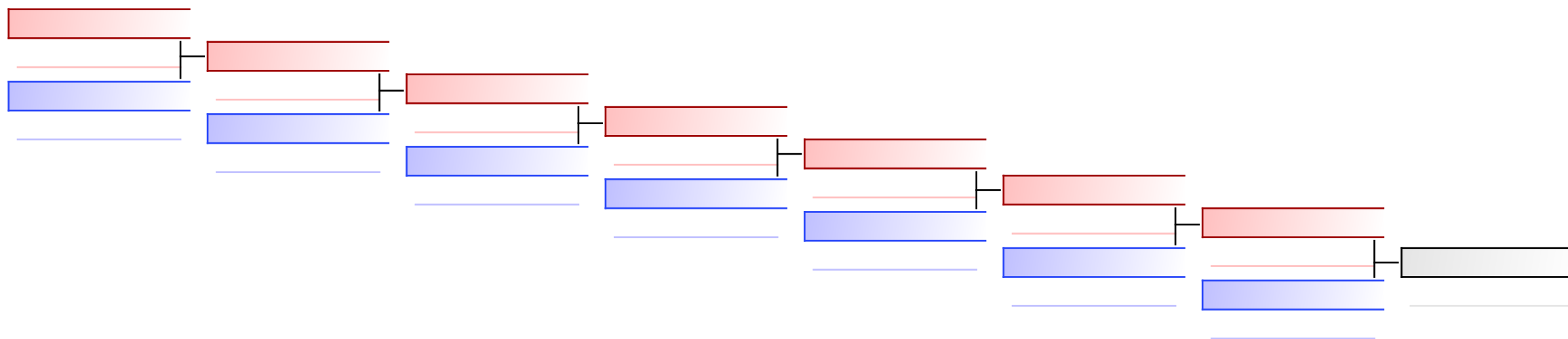

|           |  |  |  |  |  |  |  |
|-----------|--|--|--|--|--|--|--|
| Referees: |  |  |  |  |  |  |  |
|-----------|--|--|--|--|--|--|--|



Offene Landesmeisterschaft Hessen  
und Rheinland - Pfalz 2024 - 2024-02-03

Offizielle Ergebnisliste

| Kata Masterklasse Herren Ü30/Ü35 |                |                             |   |               |
|----------------------------------|----------------|-----------------------------|---|---------------|
| 1                                | PRIVITERA NICO | KARATE ILVESHEIM            |  | GER - GERMANY |
| 2                                | BRACKMANN ULF  | PSV MANNHEIM E.V.           |  | GER - GERMANY |
| 3                                | KRÄMER JOCHEN  | KARATE CLUB<br>BUSHIDO BONN |  | GER - GERMANY |





# KATA MASTERKLASSE HERREN U



# Offene Landesmeisterschaft Hessen und Rheinland -..

## ENTRIES BY WEIGHT CATEGORY

### Kata Masterklasse Herren Ü45

As of 4 FEB 2024

| NOC Code | Gender | Name                | Seeding |
|----------|--------|---------------------|---------|
| GER      | M      | Boehm Thilo         |         |
| GER      | M      | Budde Kai           |         |
| GER      | M      | Habermehl Thomas    |         |
| GER      | M      | Klöditz Markus      |         |
| GER      | M      | Kraus Sebastian     |         |
| GER      | M      | Miedel Günter       |         |
| GER      | M      | Perrone Giorgio     |         |
| GER      | M      | Schönfelder Michael |         |
| GER      | M      | Spitzmüller Ralf    |         |
| GER      | M      | Trzeciak Michael    |         |

# Kata Masterklasse Herren Ü45

Offene Landesmeisterschaft Hessen und Rheinland - Pfalz 2024, Schulstraße 2, 69509 Mörlenbach, GER

2024-02-03

Tatami

6 10:30

Pool

1/1

Budde Kai (KD Mainz Bretzenheim)

021 Gojushiho Sho

21

Budde Kai (KD Mainz Bretzenheim)

Miedel Günter (SV Alsbach)

091 Sochin

0

021 Gojushiho Sho

2130

Spitzmüller Ralf (Stuttgart DG)

091 Sochin

2090

Spitzmüller Ralf (Stuttgart DG)

041 Kanku Sho

2070

Finale

Boehm Thilo (BCRN)

020 Gojushiho Dai

3750

Habermehl Thomas (PSV MA)

041 Kanku Sho

2080

Boehm Thilo (BCRN)

091 Sochin

2200

Boehm Thilo (BCRN)

021 Gojushiho Sho

2180

~~Schönfelder Michael (UNSU Team)~~

Trzeciak Michael (KV Rosbach)

020 Gojushiho Dai

2080

020 Gojushiho Dai

Trzeciak Michael (KV Rosbach)

021 Gojushiho Sho

2130

Perrone Giorgio (KVL)

021 Gojushiho Sho

1940

Klöditz Markus (SKA Rülzheim)

020 Gojushiho Dai

3840

Klöditz Markus (SKA Rülzheim)

091 Sochin

2210

Klöditz Markus (SKA Rülzheim)

021 Gojushiho Sho

2230

Kraus Sebastian (PSV Mannheim e.V.)

041 Kanku Sho

2110



|  |
|--|
| 1. KLÖDITZ MARKUS (SKA RÜLZHEIM)       |
| 2. BOEHM THILO (BCRN)                  |
| 3. HABERMEHL THOMAS (PSV MA)           |
| 3. TRZECIAK MICHAEL (KV ROSBACH)       |
| 5. SPITZMÜLLER RALF (STUTT GART DG)    |
| 5. KRAUS SEBASTIAN (PSV MANNHEIM E.V.) |
|  |
|  |

|           |  |  |  |
|-----------|--|--|--|
| Referees: |  |  |  |
|           |  |  |  |

# Kata Masterklasse Herren Ü45

Offene Landesmeisterschaft Hessen und Rheinland - Pfalz 2024

2024-02-03

Tatami  
6 11:10

Pool  
1

(c)sportdata GmbH & Co KG 2000-2024 (2024-02-04 18:16) v 10.1.0 build 1 (2024-01-30 21:40 CET) Lizenz: Online\_Event\_ID-7816\_OffeneLandesmeisterschaftHessenundRheinlandPfalz2024 (expire 2024-02-18)

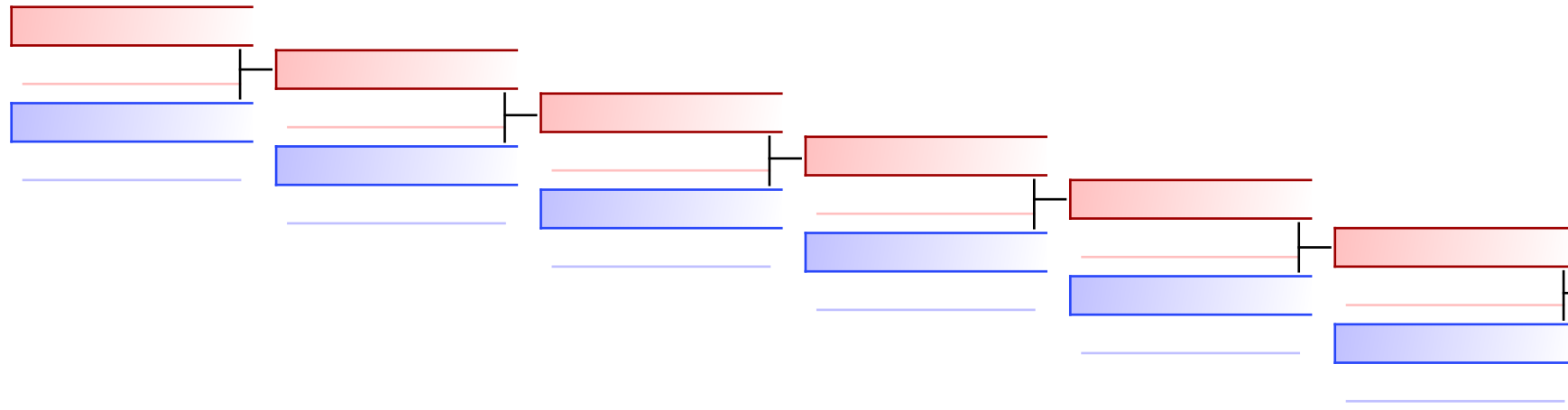

**Habermehl Thomas (PSV MA)**  
015 Gankaku | 3610

**Habermehl Thomas (PSV MA)**  
 **Spitzmüller Ralf (Stuttgart DG)**  
021 Gojushiho. 3590

## TROSTRUNDE: (1)

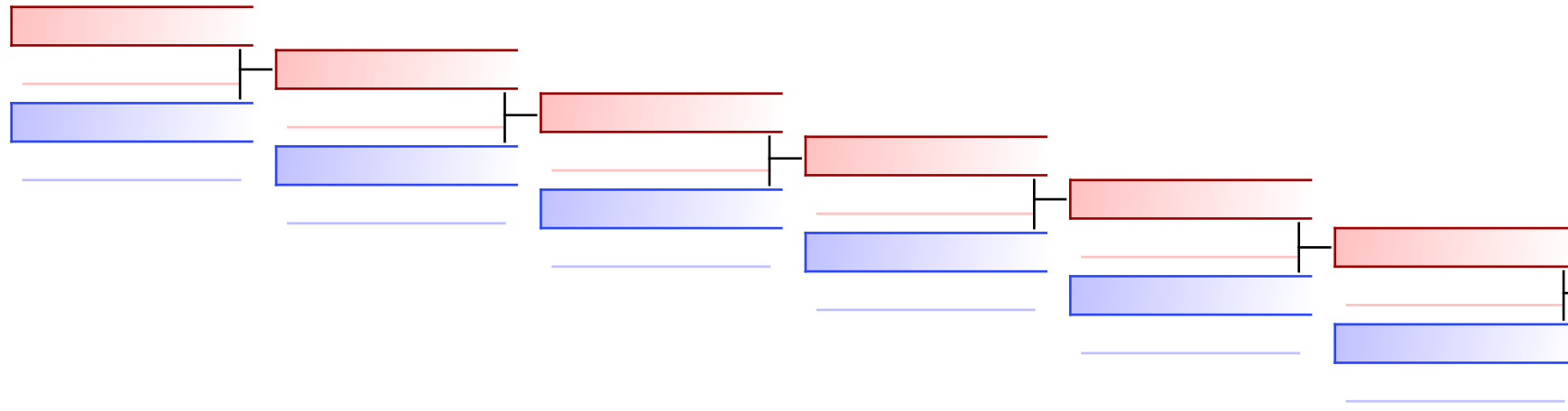

**Kraus Sebastian (PSV Mannheim e.V.)**  
012 Enpi | 3570

**Trzeciak Michael (KV Rosbach)**  
 **Trzeciak Michael (KV Rosbach)**  
041 Kanku Sho 3580

|           |  |  |  |  |  |  |  |
|-----------|--|--|--|--|--|--|--|
| Referees: |  |  |  |  |  |  |  |
|-----------|--|--|--|--|--|--|--|



Offene Landesmeisterschaft Hessen  
und Rheinland - Pfalz 2024 - 2024-02-03

Offizielle Ergebnisliste

| Kata Masterklasse Herren Ü45 |                  |   |  |               |
|------------------------------|------------------|---|--|---------------|
| 1                            | KLÖDITZ MARKUS   | SHOTOKAN<br>RYU KARATE<br>DO AKADEMIE<br>RÜLZHEIM |  | GER - GERMANY |
| 2                            | BOEHM THILO      | BUDOCLUB RHEIN<br>NECKAR E.V.                     |  | GER - GERMANY |
| 3                            | HABERMEHL THOMAS | PSV MANNHEIM                                      |  | GER - GERMANY |
| 3                            | TRZECIAK MICHAEL | KV ROSBACH  |  | GER - GERMANY |
| 5                            | SPITZMÜLLER RALF | STUTTGART<br>DOJOGEMEINSCHAFT                     |  | GER - GERMANY |
| 5                            | KRAUS SEBASTIAN  | PSV MANNHEIM E.V.                                 |  | GER - GERMANY |

# KATA MASTERKLASSE HERREN U



# Offene Landesmeisterschaft Hessen und Rheinland -..

## ENTRIES BY WEIGHT CATEGORY

### Kata Masterklasse Herren Ü55

As of 4 FEB 2024

| NOC Code | Gender | Name                | Seeding |
|----------|--------|---------------------|---------|
| GER      | M      | Bellingeri Stefano  |         |
| GER      | M      | Böhm Thomas         |         |
| GER      | M      | Dielmann Rainer     |         |
| GER      | M      | Janetzki Herbert    |         |
| GER      | M      | Kienle Jürgen       |         |
| GER      | M      | Miltenburger Thomas |         |
| GER      | M      | Müller Uwe          |         |
| GER      | M      | Ochs Wilfried       |         |
| GER      | M      | Sailer Torsten      |         |
| GER      | M      | Schmidt Dr. Andreas |         |
| GER      | M      | Steffes Roland      |         |
| GER      | M      | Wilhelm Rainer      |         |
| GER      | M      | Wolf Marcus         |         |

# Kata Masterklasse Herren Ü55

Offene Landesmeisterschaft Hessen und Rheinland - Pfalz 2024, Schulstraße 2, 69509 Mörlenbach, GER

2024-02-03

Tatami  
3 10:15

Pool  
1/1

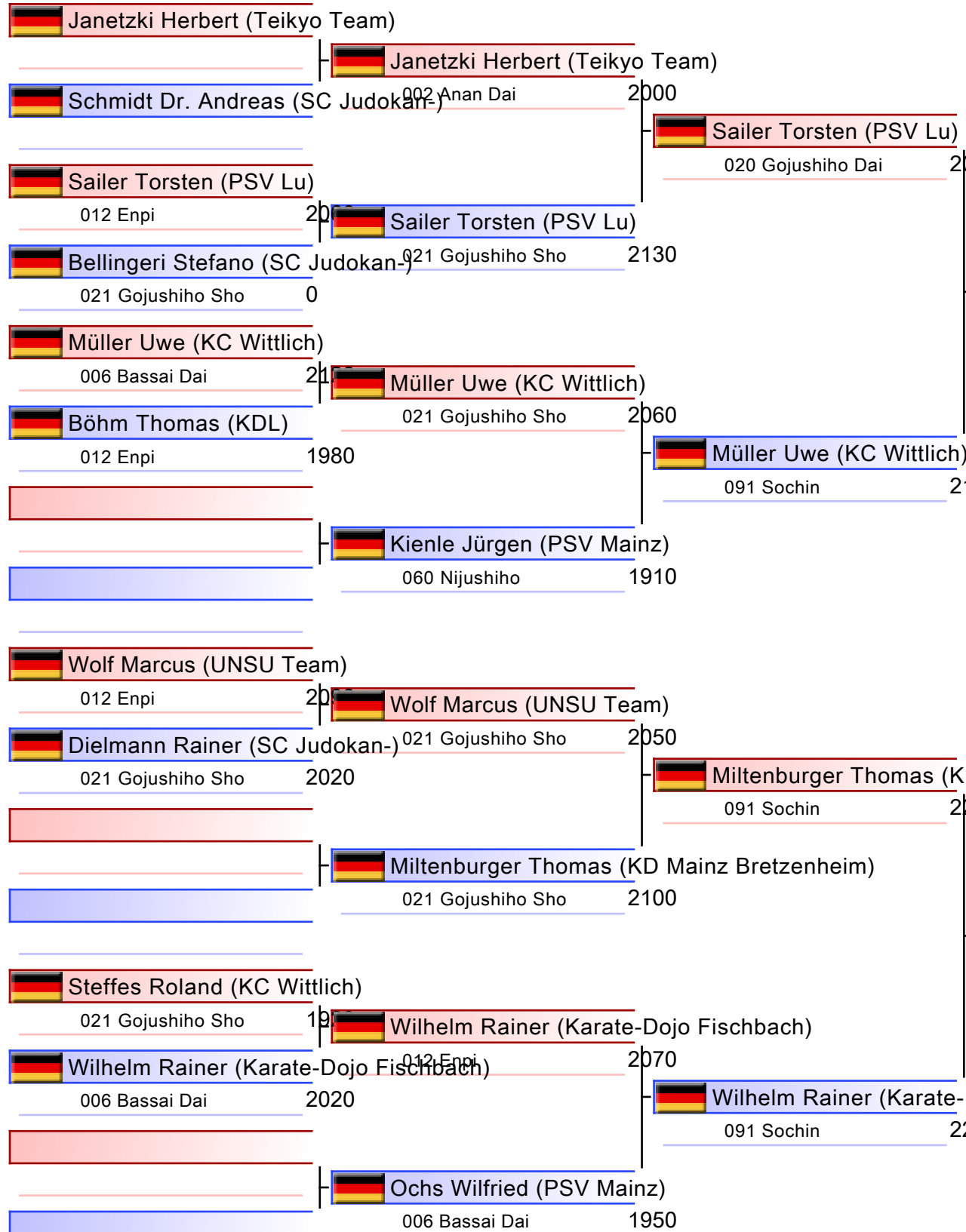

- |   |
|---|
| 1. WILHELM RAINER (KARATE-DOJO FISCHBACH)     |
| 2. MÜLLER UWE (KC WITTLICH)                   |
| 3. SAILER TORSTEN (PSV LU)                    |
| 3. MILTENBURGER THOMAS (KD MAINZ BRETZENHEIM) |
| 5. BÖHM THOMAS (KDL)                          |
| 5. OCHS WILFRIED (PSV MAINZ)                  |
| 7. KIENLE JÜRGEN (PSV MAINZ)                  |
| 7. STEFFES ROLAND (KC WITTLICH)               |

|           |  |  |  |
|-----------|--|--|--|
| Referees: |  |  |  |
|           |  |  |  |



# Kata Masterklasse Herren Ü55

Offene Landesmeisterschaft Hessen und Rheinland - Pfalz 2024

2024-02-03

Tatami  
3 11:10

Pool  
1

(c)sportdata GmbH & Co KG 2000-2024 (2024-02-04 18:16) v 10.1.0 build 1 (2024-01-30 21:40 CET) Lizenz: Online\_Event\_ID-7816\_OffeneLandesmeisterschaftHessenundRheinlandPfalz2024 (expire 2024-02-18)

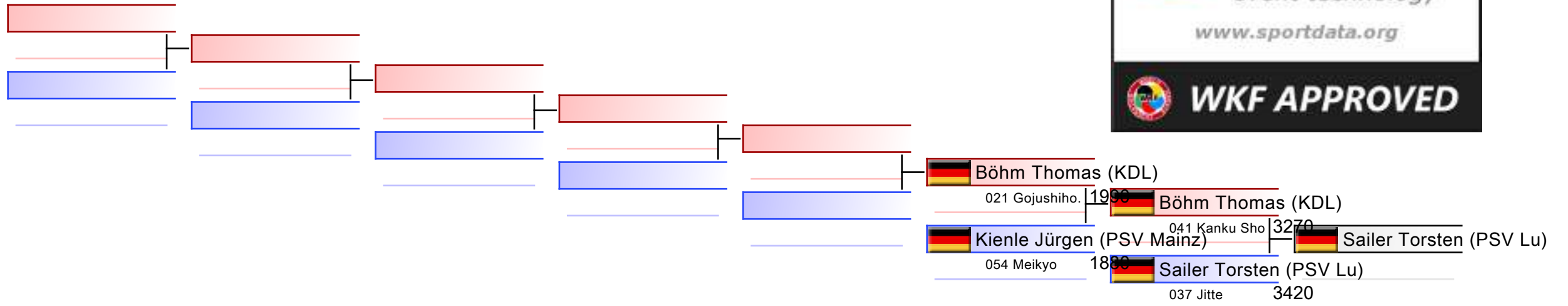

## TROSTRUNDE: (1)

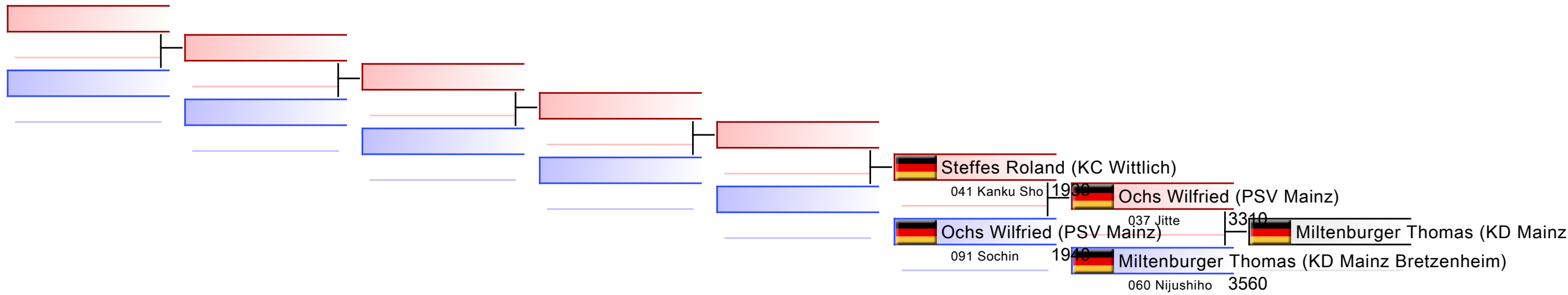

|           |  |  |  |  |  |  |  |
|-----------|--|--|--|--|--|--|--|
| Referees: |  |  |  |  |  |  |  |
|-----------|--|--|--|--|--|--|--|



Offene Landesmeisterschaft Hessen  
und Rheinland - Pfalz 2024 - 2024-02-03

Offizielle Ergebnisliste

| Kata Masterklasse Herren Ü55 |                     |                                      |   |               |
|------------------------------|---------------------|--------------------------------------|---|---------------|
| 1                            | WILHELM RAINER      | KARATE-DOJO<br>FISCHBACH             |  | GER - GERMANY |
| 2                            | MÜLLER UWE          | KARATE CLUB<br>WITTLICH              |  | GER - GERMANY |
| 3                            | SAILER TORSTEN      | PSV LUDWIGSHAFEN<br>GRÜN WEISS       |  | GER - GERMANY |
| 3                            | MILTENBURGER THOMAS | KARATE DOJO MAINZ<br>BRETZENHEIM E.V |  | GER - GERMANY |
| 5                            | BÖHM THOMAS         | KARATE-DOJO LICH<br>E.V.             |  | GER - GERMANY |
| 5                            | OCHS WILFRIED       | POLIZEI<br>SPORTVEREIN<br>MAINZ E.V. |  | GER - GERMANY |
| 7                            | KIENLE JÜRGEN       | POLIZEI<br>SPORTVEREIN<br>MAINZ E.V. |  | GER - GERMANY |
| 7                            | STEFFES ROLAND      | KARATE CLUB<br>WITTLICH              |  | GER - GERMANY |

# KATA MASTERKLASSE HERREN U



# Offene Landesmeisterschaft Hessen und Rheinland -..

## ENTRIES BY WEIGHT CATEGORY

### Kata Masterklasse Herren Ü65

As of 4 FEB 2024

| NOC Code | Gender | Name              | Seeding |
|----------|--------|-------------------|---------|
| GER      | M      | Adam Wolfgang     |         |
| GER      | M      | Birli Josef       |         |
| GER      | M      | Blank Louis       |         |
| GER      | M      | Mittenzwey Rainer |         |
| GER      | M      | Petzel Norbert    |         |
| GER      | M      | Sack Klaus-Dieter |         |

# Kata Masterklasse Herren Ü65

Offene Landesmeisterschaft Hessen und Rheinland - Pfalz 2024, Schulstraße 2, 69509 Mörlenbach, GER

2024-02-03

Tatami  
2 10:20

Pool  
1/1

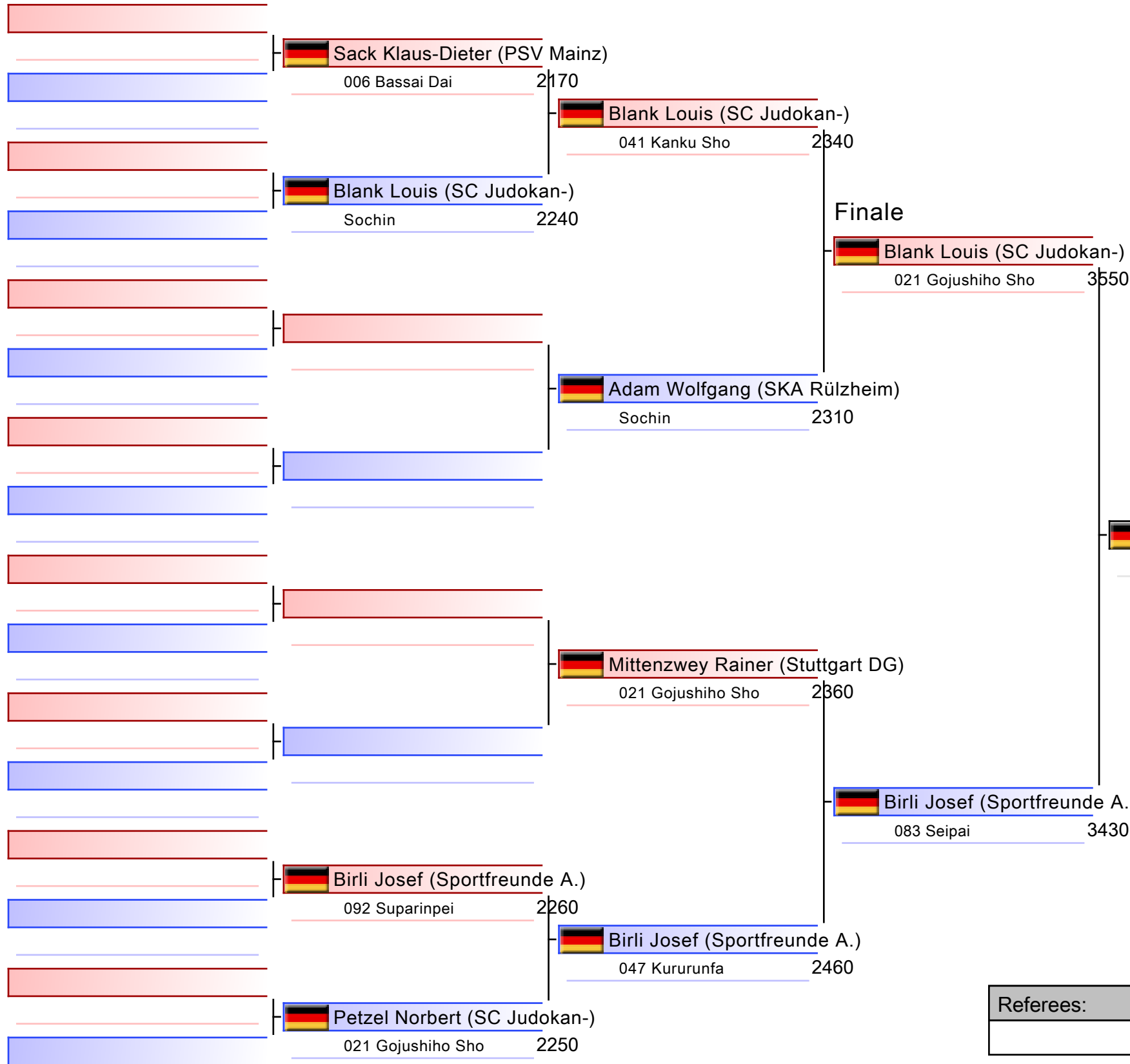

|                                     |
|-------------------------------------|
| 1. BLANK LOUIS (SC JUDOKAN-)        |
| 2. BIRLI JOSEF (SPORTFREUNDE A.)    |
| 3. ADAM WOLFGANG (SKA RÜLZHEIM)     |
| 3. MITTENZWEY RAINER (STUTTGART DG) |
| 5. SACK KLAUS-DIETER (PSV MAINZ)    |
| 5. PETZEL NORBERT (SC JUDOKAN-)     |
|                                     |
|                                     |

|           |  |  |  |
|-----------|--|--|--|
| Referees: |  |  |  |
|           |  |  |  |

# Kata Masterklasse Herren Ü65

Offene Landesmeisterschaft Hessen und Rheinland - Pfalz 2024

2024-02-03

Tatami  
2 10:35

Pool  
1

(c)sportdata GmbH & Co KG 2000-2024 (2024-02-04 18:16) v 10.1.0 build 1 (2024-01-30 21:40 CET) Lizenz: Online\_Event\_ID-7816\_OffeneLandesmeisterschaftHessenundRheinlandPfalz2024 (expire 2024-02-18)

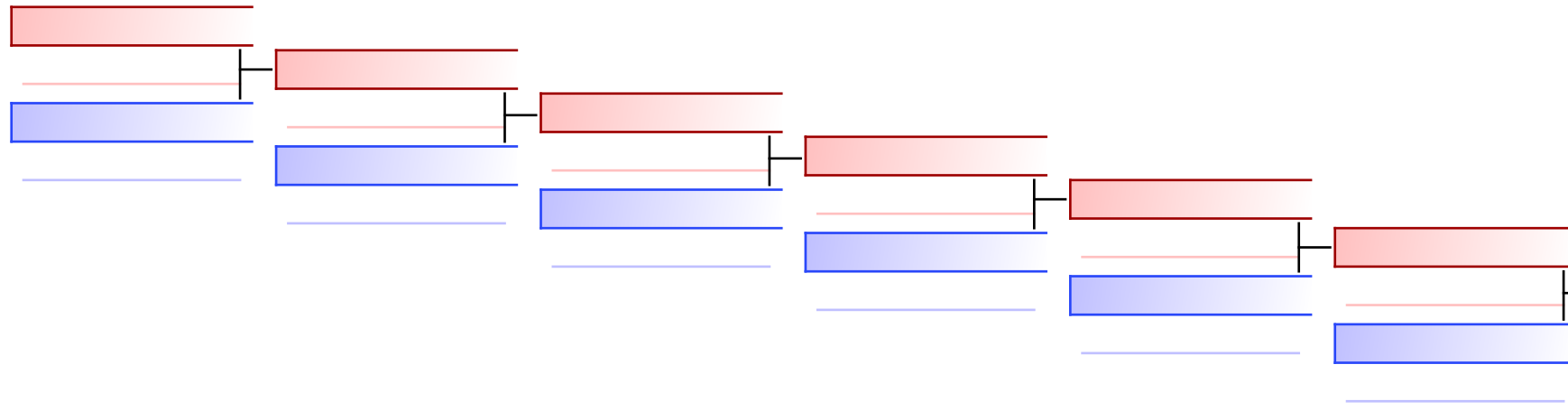

Sack Klaus-Dieter (PSV Mainz)  
012 Enpi 3670

Adam Wolfgang (SKA Rülzheim)  
060 Nijushiho 3870

## TROSTRUNDE: (1)

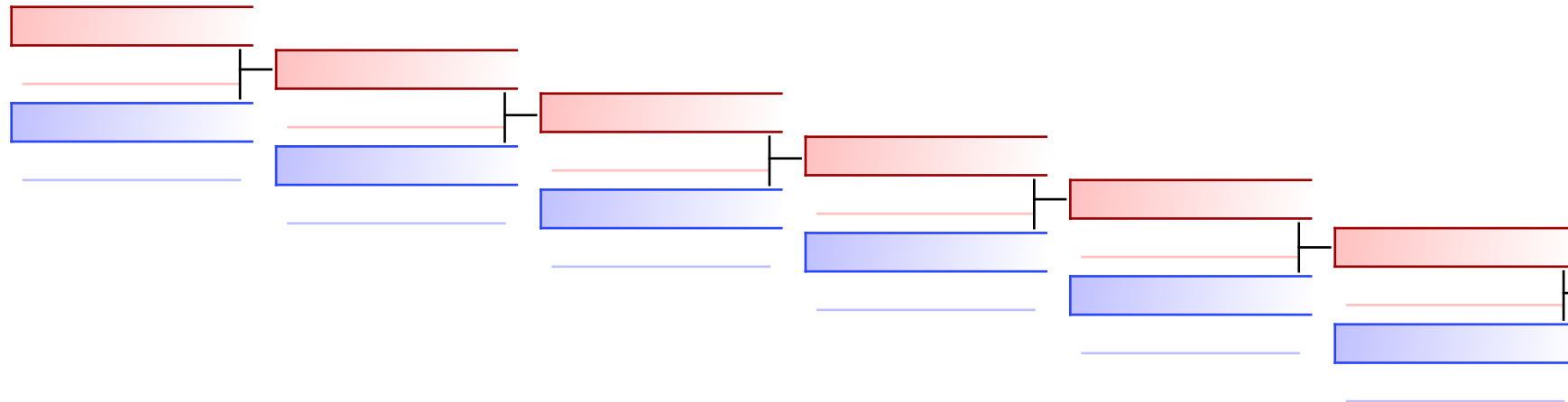

Petzel Norbert (SC Judokan-)  
020 Gojushiho 3810

Mittenzwey Rainer (Stuttgart DG)  
091 Sochin 3840

|           |  |  |  |  |  |  |  |
|-----------|--|--|--|--|--|--|--|
| Referees: |  |  |  |  |  |  |  |
|-----------|--|--|--|--|--|--|--|



Offene Landesmeisterschaft Hessen  
und Rheinland - Pfalz 2024 - 2024-02-03

Offizielle Ergebnisliste

| Kata Masterklasse Herren Ü65 |                   |   |  |               |
|------------------------------|-------------------|---|--|---------------|
| 1                            | BLANK LOUIS       | SC JUDOKAN E.V.                                   |  | GER - GERMANY |
| 2                            | BIRLI JOSEF       | SPORTFREUNDE<br>AFFATRA E.V.                      |  | GER - GERMANY |
| 3                            | ADAM WOLFGANG     | SHOTOKAN<br>RYU KARATE<br>DO AKADEMIE<br>RÜLZHEIM |  | GER - GERMANY |
| 3                            | MITTENZWEY RAINER | STUTT GART<br>DOJOGEMEINSCHAFT                    |  | GER - GERMANY |
| 5                            | SACK KLAUS-DIETER | POLIZEI<br>SPORTVEREIN<br>MAINZ E.V.              |  | GER - GERMANY |
| 5                            | PETZEL NORBERT    | SC JUDOKAN E.V.                                   |  | GER - GERMANY |

# KUMITE MASTERKLASSE DAMEN





# Offene Landesmeisterschaft Hessen und Rheinland -..

## ENTRIES BY WEIGHT CATEGORY

### Kumite Masterklasse Damen

As of 4 FEB 2024

| NOC Code | Gender | Name               | Seeding |
|----------|--------|--------------------|---------|
| GER      | F      | Hamami Joheina     |         |
| GER      | F      | HOLCZER STELLA     |         |
| GER      | F      | Niederelz Martina  |         |
| GER      | F      | Schwanenberg Maike |         |

# Kumite Masterklasse Damen

Offene Landesmeisterschaft Hessen und Rheinland - Pfalz 2024, Schulstraße 2, 69509 Mörlenbach, GER

2024-02-03

Tatami  
3 15:00

Pool  
1/1

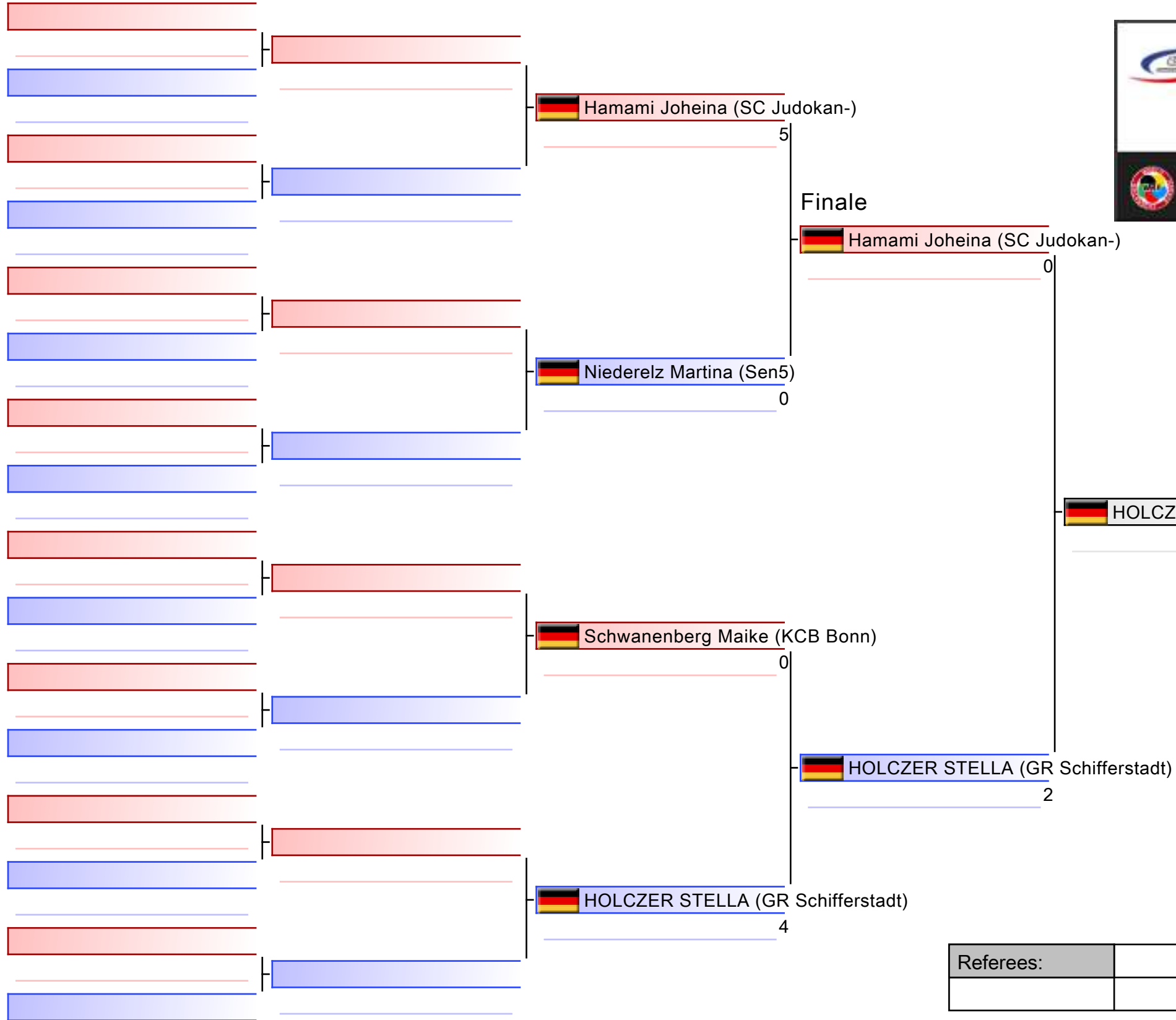

|                                      |
|--------------------------------------|
| 1. HOLCZER STELLA (GR SCHIFFERSTADT) |
| 2. HAMAMI JOHEINA (SC JUDOKAN-)      |
|                                      |
|                                      |
|                                      |
|                                      |
|                                      |

|           |  |  |  |
|-----------|--|--|--|
| Referees: |  |  |  |
|           |  |  |  |



Offene Landesmeisterschaft Hessen  
und Rheinland - Pfalz 2024 - 2024-02-03

Offizielle Ergebnisliste

| Kumite Masterklasse Damen |                |  |   |               |  |
|---------------------------|----------------|--|---|---------------|--|
| 1                         | HOLCZER STELLA | GOJU-RYU<br>KARATEVEREIN<br>SCHIFFERSTADT E.V. |  | GER - GERMANY |  |
| 2                         | HAMAMI JOHEINA | SC JUDOKAN E.V.                                |  | GER - GERMANY |  |



KUMITE MASTERKLASSE HERRE  
Ü35 +80 KG



# Offene Landesmeisterschaft Hessen und Rheinland -..

## ENTRIES BY WEIGHT CATEGORY

### Kumite Masterklasse Herren Ü35 +80 kg

As of 4 FEB 2024

| NOC Code | Gender | Name              | Seeding |
|----------|--------|-------------------|---------|
| GER      | M      | Boger Patrick     |         |
| GER      | M      | Eck Benjamin      |         |
| GER      | M      | Krämer Jochen     |         |
| GER      | M      | Ndagijimana Abdou |         |
| GER      | M      | Ullrich Thomas    |         |

# Kumite Masterklasse Herren Ü35 +80 kg

Offene Landesmeisterschaft Hessen und Rheinland - Pfalz 2024, Schulstraße 2, 69509 Mörlenbach, GER

2024-02-03

Tatami  
3 15:10

Pool  
1/1

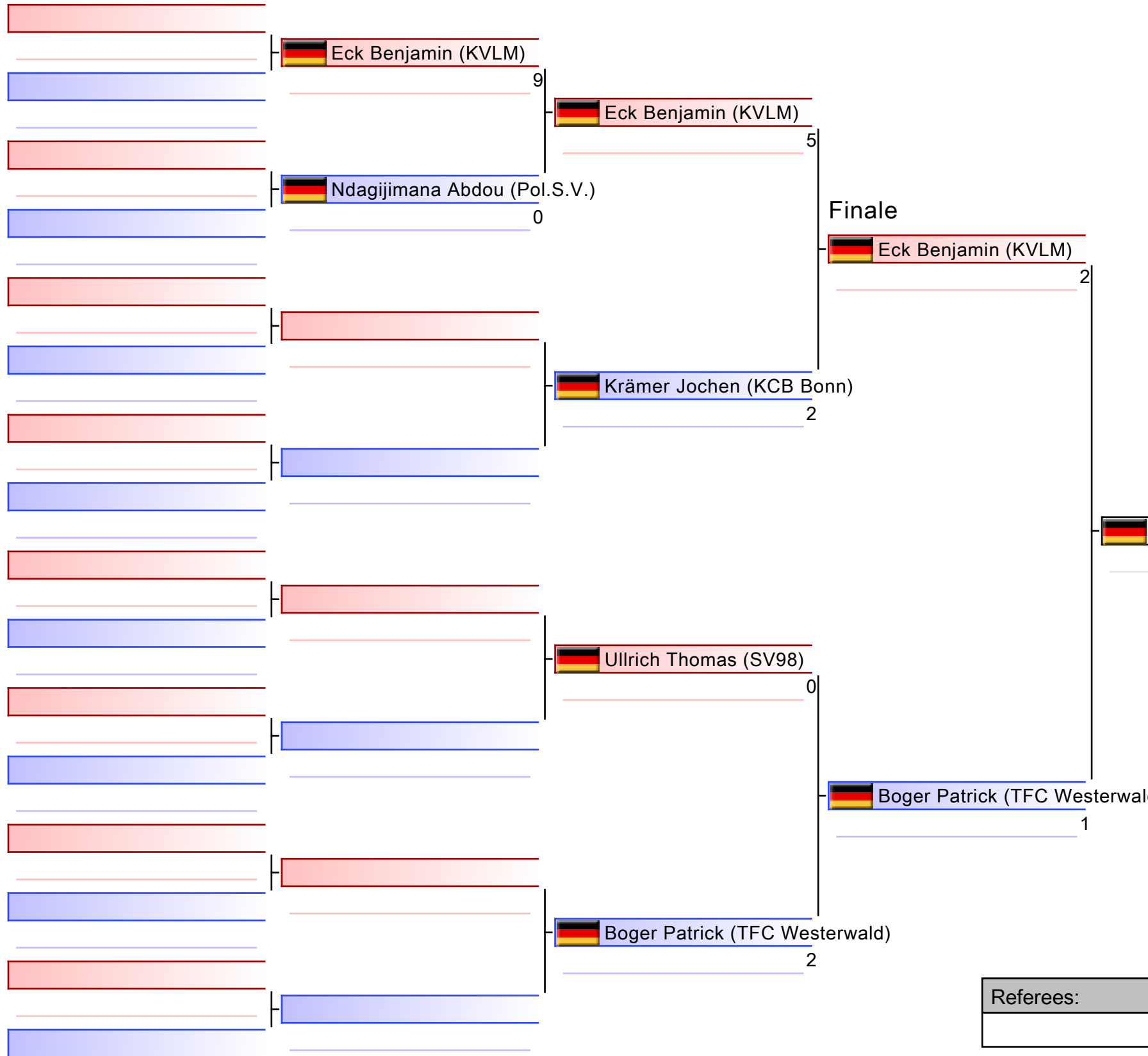

|                                   |
|-----------------------------------|
| 1. ECK BENJAMIN (KVLM)            |
| 2. BOGER PATRICK (TFC WESTERWALD) |
| 3. ULLRICH THOMAS (SV98)          |
| 3. KRÄMER JOCHEN (KCB BONN)       |
| 5. NDAGIJIMANA ABDOU (POL.S.V.)   |
|                                   |
|                                   |

|           |  |  |  |
|-----------|--|--|--|
| Referees: |  |  |  |
|           |  |  |  |

# Kumite Masterklasse Herren Ü35 +80 kg

Offene Landesmeisterschaft Hessen und Rheinland - Pfalz 2024

2024-02-03

Tatami

3 15:25

Pool

1

(c)sportdata GmbH & Co KG 2000-2024 (2024-02-04 18:16) v 10.1.0 build 1 (2024-01-30 21:40 CET) Lizenz: Online\_Event\_ID-7816\_OffeneLandesmeisterschaftHessenundRheinlandPfalz2024 (expire 2024-02-18)

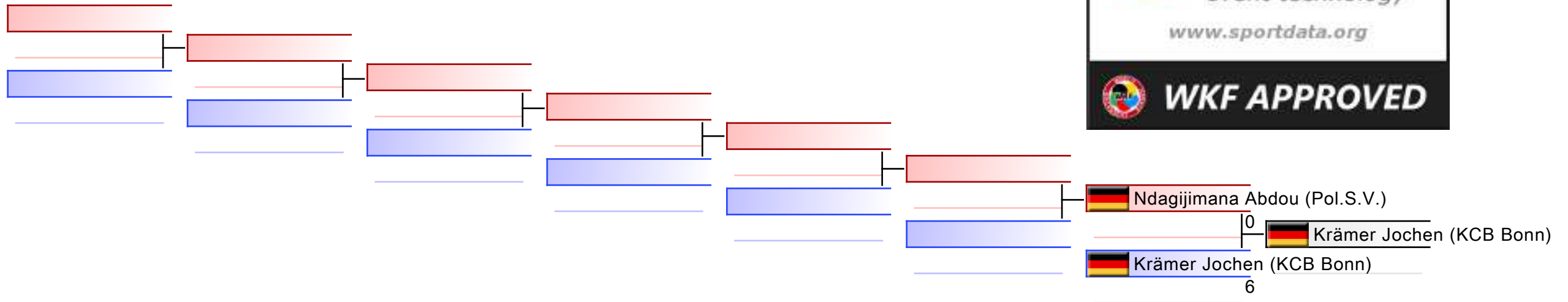

## TROSTRUNDE: (1)

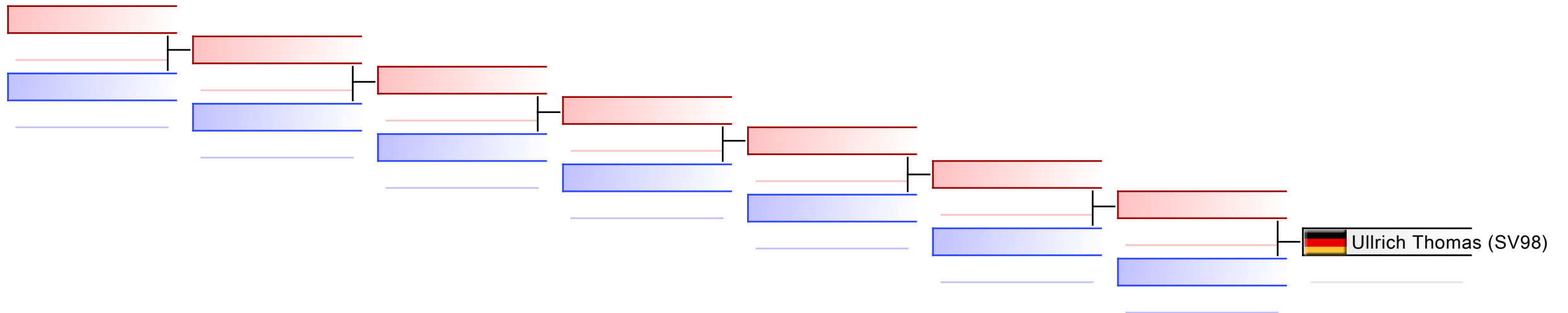

|           |  |  |  |  |  |  |  |
|-----------|--|--|--|--|--|--|--|
| Referees: |  |  |  |  |  |  |  |
|-----------|--|--|--|--|--|--|--|



Offene Landesmeisterschaft Hessen  
und Rheinland - Pfalz 2024 - 2024-02-03

Offizielle Ergebnisliste

| Kumite Masterklasse Herren Ü35 +80 kg |                   |  |   |               |
|---------------------------------------|-------------------|--|---|---------------|
| 1                                     | ECK BENJAMIN      | KV LIMBURG                                       |  | GER - GERMANY |
| 2                                     | BOGER PATRICK     | TEAM FIGHTCLUB<br>WESTERWALD                     |  | GER - GERMANY |
| 3                                     | ULLRICH THOMAS    | SV DARMSTADT 98                                  |  | GER - GERMANY |
| 3                                     | KRÄMER JOCHEN     | KARATE CLUB<br>BUSHIDO BONN                      |  | GER - GERMANY |
| 5                                     | NDAGIJIMANA ABDOU | POLIZEISPORTVEREIN<br>GRÜN WEISS<br>KOBLENZ E.V. |  | GER - GERMANY |



KUMITE MASTERKLASSE HERRE  
Ü35 -80 KG



# Offene Landesmeisterschaft Hessen und Rheinland -..

## ENTRIES BY WEIGHT CATEGORY

### Kumite Masterklasse Herren Ü35 -80 kg

As of 4 FEB 2024

| NOC Code | Gender | Name            | Seeding |
|----------|--------|-----------------|---------|
| GER      | M      | Dressler Kurt   |         |
| GER      | M      | Rost Benjamin   |         |
| GER      | M      | Schoppel Martin |         |
| GER      | M      | Stahl Steffen   |         |

# Kumite Masterklasse Herren Ü35 -80 kg

Offene Landesmeisterschaft Hessen und Rheinland - Pfalz 2024, Schulstraße 2, 69509 Mörlenbach, GER

2024-02-03

Tatami  
2 15:05

Pool  
1/1

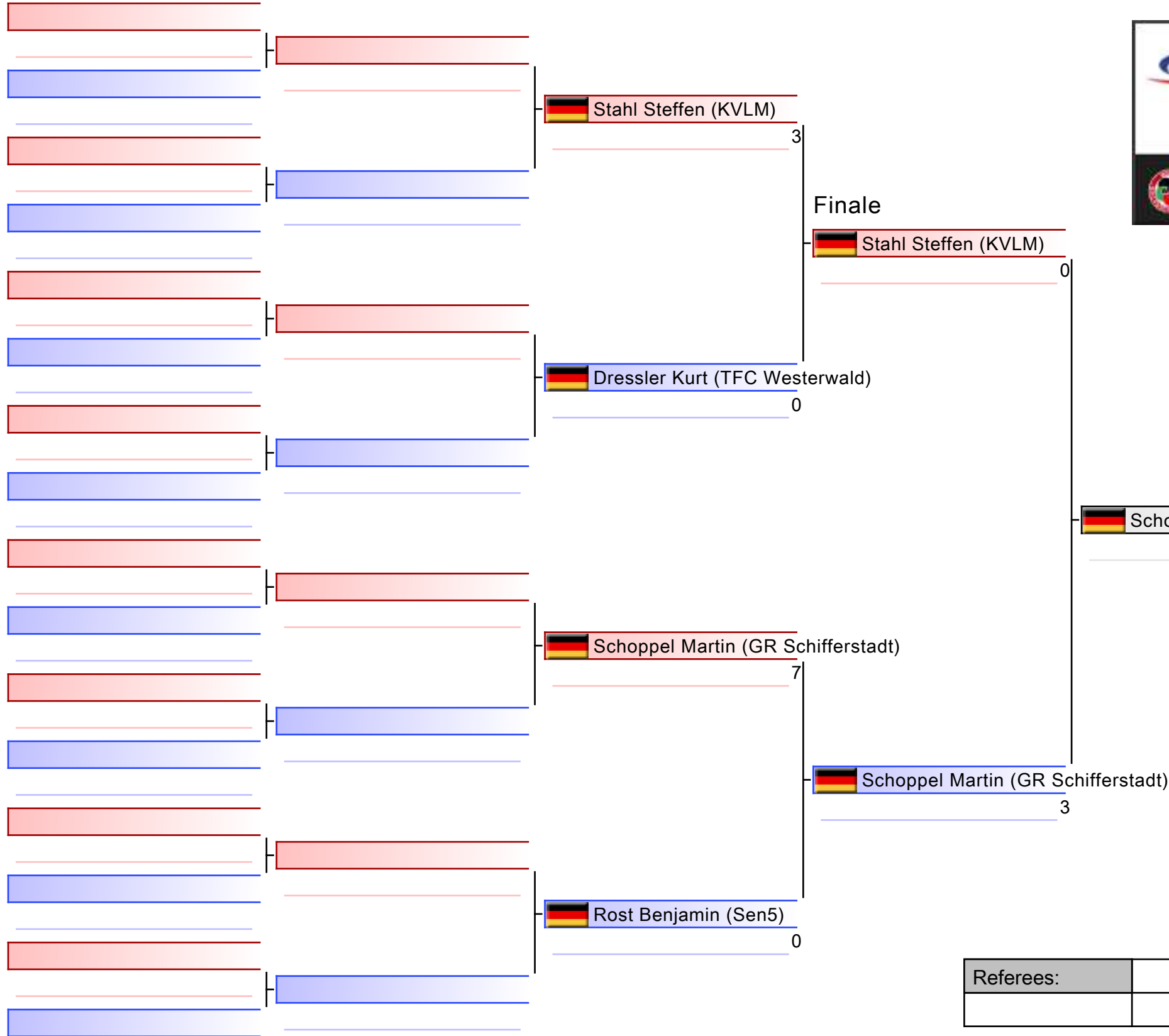

|                                       |
|---------------------------------------|
| 1. SCHOPPEL MARTIN (GR SCHIFFERSTADT) |
| 2. STAHL STEFFEN (KVLM)               |
| 3. DRESSLER KURT (TFC WESTERWALD)     |
| 3. ROST BENJAMIN (SEN5)               |
|                                       |
|                                       |
|                                       |

|           |  |  |  |
|-----------|--|--|--|
| Referees: |  |  |  |
|           |  |  |  |

# Kumite Masterklasse Herren Ü35 -80 kg

Offene Landesmeisterschaft Hessen und Rheinland - Pfalz 2024

Tatami

Pool

1

(c)sportdata GmbH & Co KG 2000-2024 (2024-02-04 18:16) v 10.1.0 build 1 (2024-01-30 21:40 CET) Lizenz: Online\_Event\_ID-7816\_OffeneLandesmeisterschaftHessenundRheinlandPfalz2024 (expire 2024-02-18)

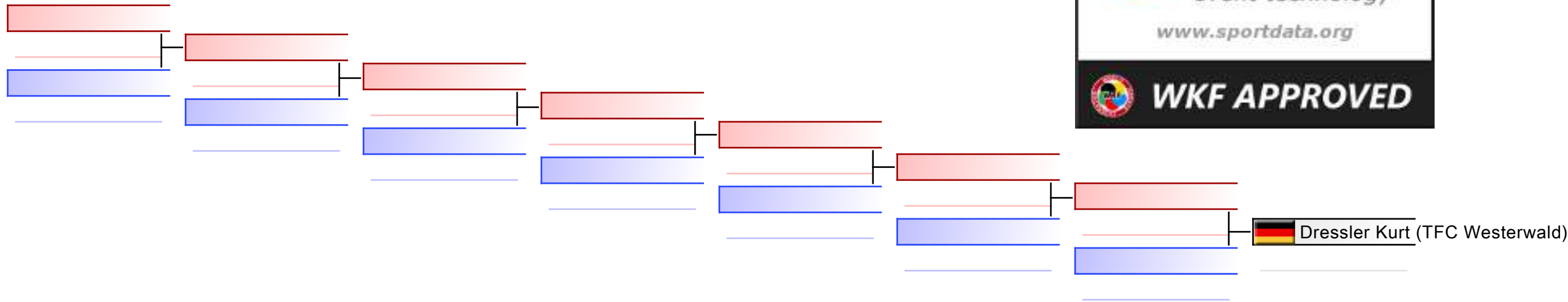

## TROSTRUNDE: (1)

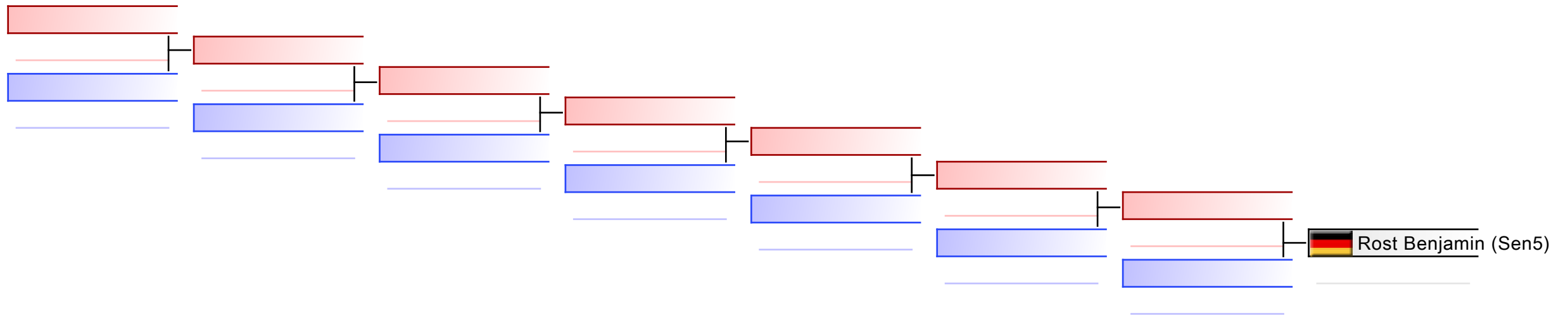

|           |  |  |  |  |  |  |  |
|-----------|--|--|--|--|--|--|--|
| Referees: |  |  |  |  |  |  |  |
|-----------|--|--|--|--|--|--|--|



Offene Landesmeisterschaft Hessen  
und Rheinland - Pfalz 2024 - 2024-02-03

Offizielle Ergebnisliste

| Kumite Masterklasse Herren Ü35 -80 kg |                 |  |   |               |
|---------------------------------------|-----------------|--|---|---------------|
| 1                                     | SCHOPPEL MARTIN | GOJU-RYU<br>KARATEVEREIN<br>SCHIFFERSTADT E.V. |  | GER - GERMANY |
| 2                                     | STAHL STEFFEN   | KV LIMBURG                                     |  | GER - GERMANY |
| 3                                     | DRESSLER KURT   | TEAM FIGHTCLUB<br>WESTERWALD                   |  | GER - GERMANY |
| 3                                     | ROST BENJAMIN   | SEN5 KARATE<br>VEREIN E.V.                     |  | GER - GERMANY |

KUMITE MASTERKLASSE HERRE  
Ü45 +80 KG



# Offene Landesmeisterschaft Hessen und Rheinland -..

## ENTRIES BY WEIGHT CATEGORY

Kumite Masterklasse Herren Ü45 +80 kg

As of 4 FEB 2024

| NOC Code | Gender | Name             | Seeding |
|----------|--------|------------------|---------|
| GER      | M      | Alhusein Anas    |         |
| GER      | M      | Trzeciak Michael |         |

# Kumite Masterklasse Herren Ü45 +80 kg

Offene Landesmeisterschaft Hessen und Rheinland - Pfalz 2024, Schulstraße 2, 69509 Mörlenbach, GER

Tatami

Pool

1/1

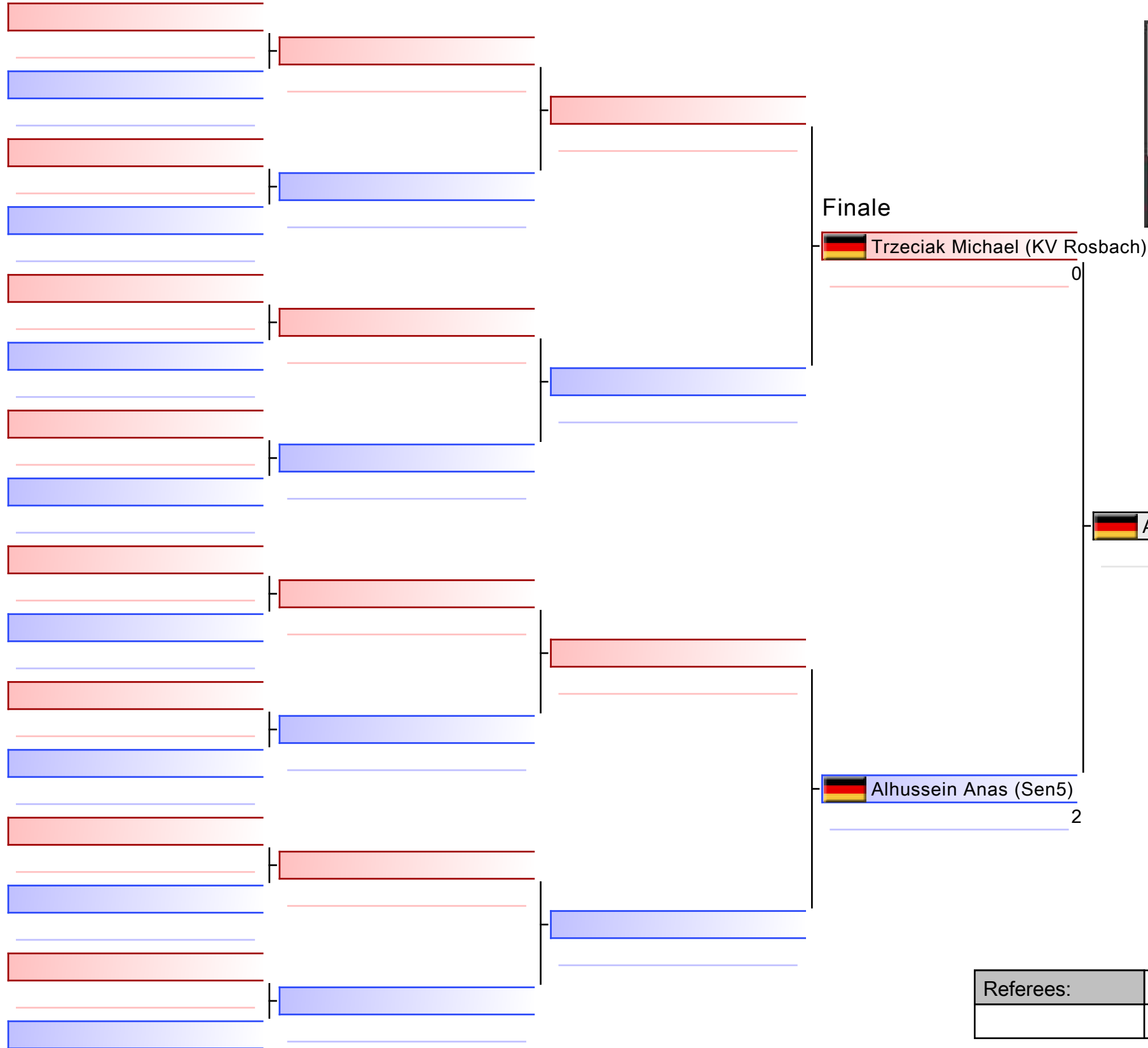

|                                  |
|----------------------------------|
| 1. ALHUSSEIN ANAS (SEN5)         |
| 2. TRZECIAK MICHAEL (KV ROSBACH) |
|                                  |
|                                  |
|                                  |
|                                  |
|                                  |

|           |  |  |  |
|-----------|--|--|--|
| Referees: |  |  |  |
|           |  |  |  |





Offene Landesmeisterschaft Hessen  
und Rheinland - Pfalz 2024 - 2024-02-03

Offizielle Ergebnisliste

| Kumite Masterklasse Herren Ü45 +80 kg |                  |                            |   |               |
|---------------------------------------|------------------|----------------------------|---|---------------|
| 1                                     | ALHUSSEIN ANAS   | SEN5 KARATE<br>VEREIN E.V. |  | GER - GERMANY |
| 2                                     | TRZECIAK MICHAEL | KV ROSBACH                 |  | GER - GERMANY |

KUMITE MASTERKLASSE HERRE  
Ü45 -80 KG



# Offene Landesmeisterschaft Hessen und Rheinland -..

## ENTRIES BY WEIGHT CATEGORY

### Kumite Masterklasse Herren Ü45 -80 kg

As of 4 FEB 2024

| NOC Code | Gender | Name           | Seeding |
|----------|--------|----------------|---------|
| GER      | M      | Jäger Markus   |         |
| GER      | M      | Matheis Martin |         |

# Kumite Masterklasse Herren Ü45 -80 kg

Offene Landesmeisterschaft Hessen und Rheinland - Pfalz 2024, Schulstraße 2, 69509 Mörlenbach, GER

Tatami

Pool  
1/1

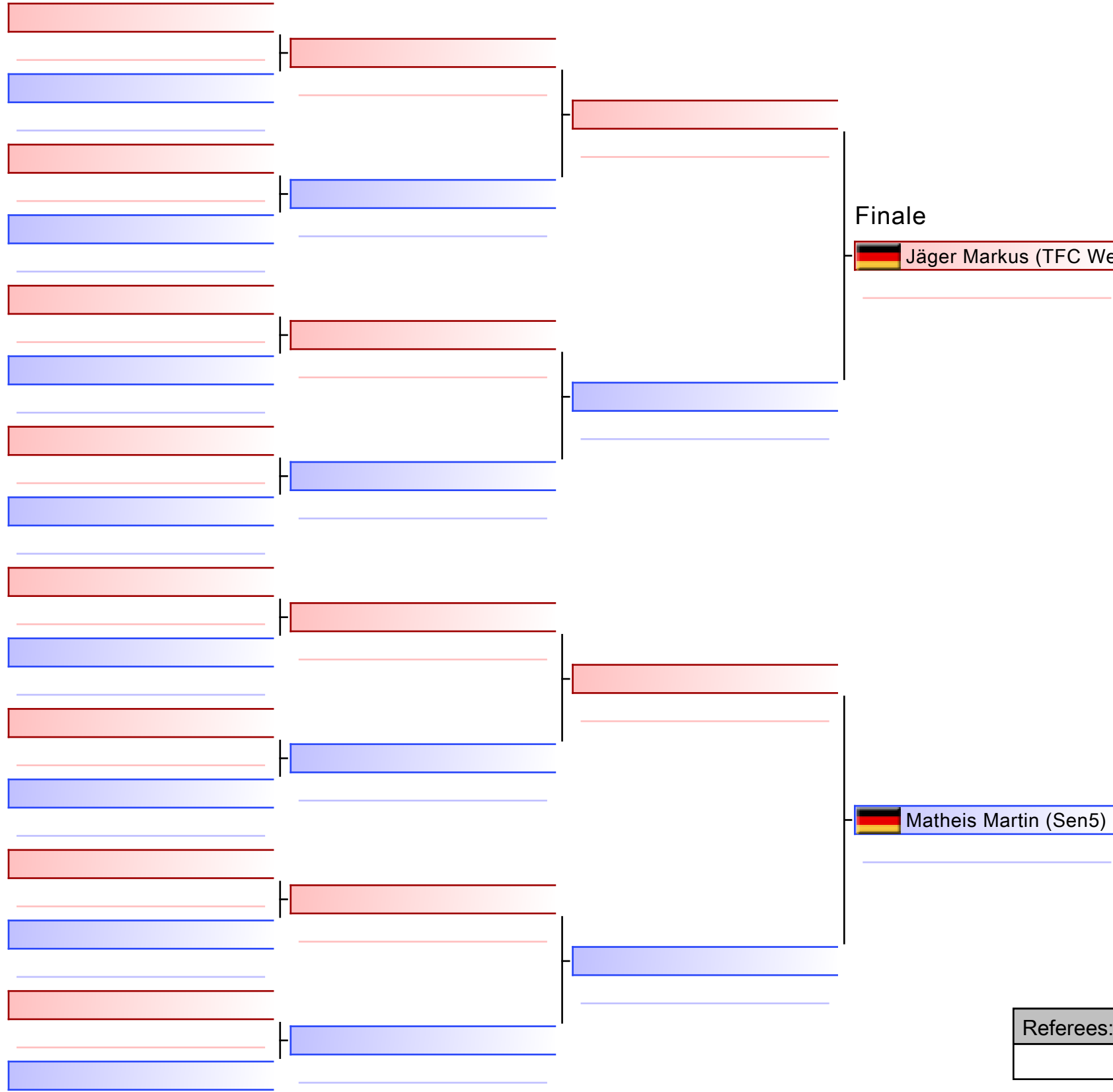

Finale

Jäger Markus (TFC Westerwald)  
6

Matheis Martin (Sen5)

Matheis Martin (Sen5)  
7

|                                  |
|----------------------------------|
| 1. MATHEIS MARTIN (SEN5)         |
| 2. JÄGER MARKUS (TFC WESTERWALD) |
|                                  |
|                                  |
|                                  |
|                                  |
|                                  |

|           |  |  |  |
|-----------|--|--|--|
| Referees: |  |  |  |
|           |  |  |  |



Offene Landesmeisterschaft Hessen  
und Rheinland - Pfalz 2024 - 2024-02-03

Offizielle Ergebnisliste

| Kumite Masterklasse Herren Ü45 -80 kg |                |                              |   |               |
|---------------------------------------|----------------|------------------------------|---|---------------|
| 1                                     | MATHEIS MARTIN | SEN5 KARATE<br>VEREIN E.V.   |  | GER - GERMANY |
| 2                                     | JÄGER MARKUS   | TEAM FIGHTCLUB<br>WESTERWALD |  | GER - GERMANY |

KUMITE MASTERKLASSE HERRE  
Ü55 +80 KG



# Offene Landesmeisterschaft Hessen und Rheinland -..

## ENTRIES BY WEIGHT CATEGORY

### Kumite Masterklasse Herren Ü55 +80 kg

As of 4 FEB 2024

| NOC Code | Gender | Name             | Seeding |
|----------|--------|------------------|---------|
| GER      | M      | Klug Hans-Jürgen |         |
| GER      | M      | Kohler Thorsten  |         |
| GER      | M      | Steffes Roland   |         |

# Kumite Masterklasse Herren Ü55 +80 kg

Offene Landesmeisterschaft Hessen und Rheinland - Pfalz 2024, Schulstraße 2, 69509 Mörlenbach, GER

2024-02-03

Tatami  
4 14:55

Pool  
1/1

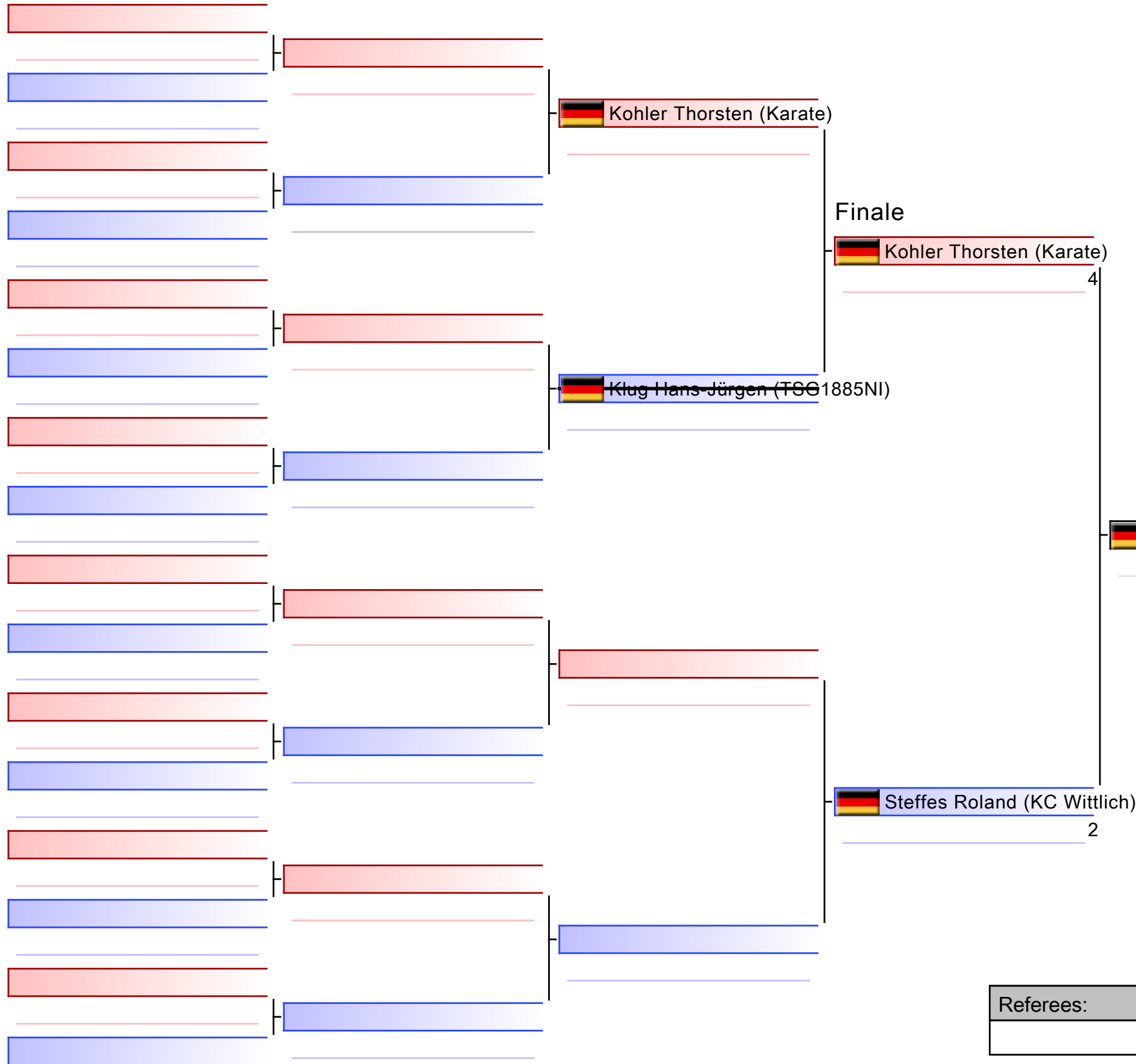

Kohler Thorsten (Karate)

- |                                 |
|---------------------------------|
| 1. KOHLER THORSTEN (KARATE)     |
| 2. STEFFES ROLAND (KC WITTLICH) |
|                                 |
|                                 |
|                                 |
|                                 |
|                                 |

|           |  |  |  |
|-----------|--|--|--|
| Referees: |  |  |  |
|           |  |  |  |





Offene Landesmeisterschaft Hessen  
und Rheinland - Pfalz 2024 - 2024-02-03

Offizielle Ergebnisliste

| Kumite Masterklasse Herren Ü55 +80 kg |                 |                              |   |               |
|---------------------------------------|-----------------|------------------------------|---|---------------|
| 1                                     | KOHLER THORSTEN | KARATE - DOJO<br>HAUSTADT EV |  | GER - GERMANY |
| 2                                     | STEFFES ROLAND  | KARATE CLUB<br>WITTLICH      |  | GER - GERMANY |

KUMITE MASTERKLASSE HERRE  
Ü55/Ü65 -80KG



# Offene Landesmeisterschaft Hessen und Rheinland -..

## ENTRIES BY WEIGHT CATEGORY

### Kumite Masterklasse Herren Ü55/Ü65 -80kg

As of 4 FEB 2024

| NOC Code | Gender | Name                 | Seeding |
|----------|--------|----------------------|---------|
| GER      | M      | Bellingeri Stefano   |         |
| GER      | M      | Blank Louis          |         |
| GER      | M      | Blatt Mario          |         |
| GER      | M      | Sturzenhecker Thomas |         |

# Kumite Masterklasse Herren Ü55/Ü65 -80kg

Offene Landesmeisterschaft Hessen und Rheinland - Pfalz 2024, Schulstraße 2, 69509 Mörlenbach, GER

2024-02-03

Tatami

4 15:00

Pool

1/1

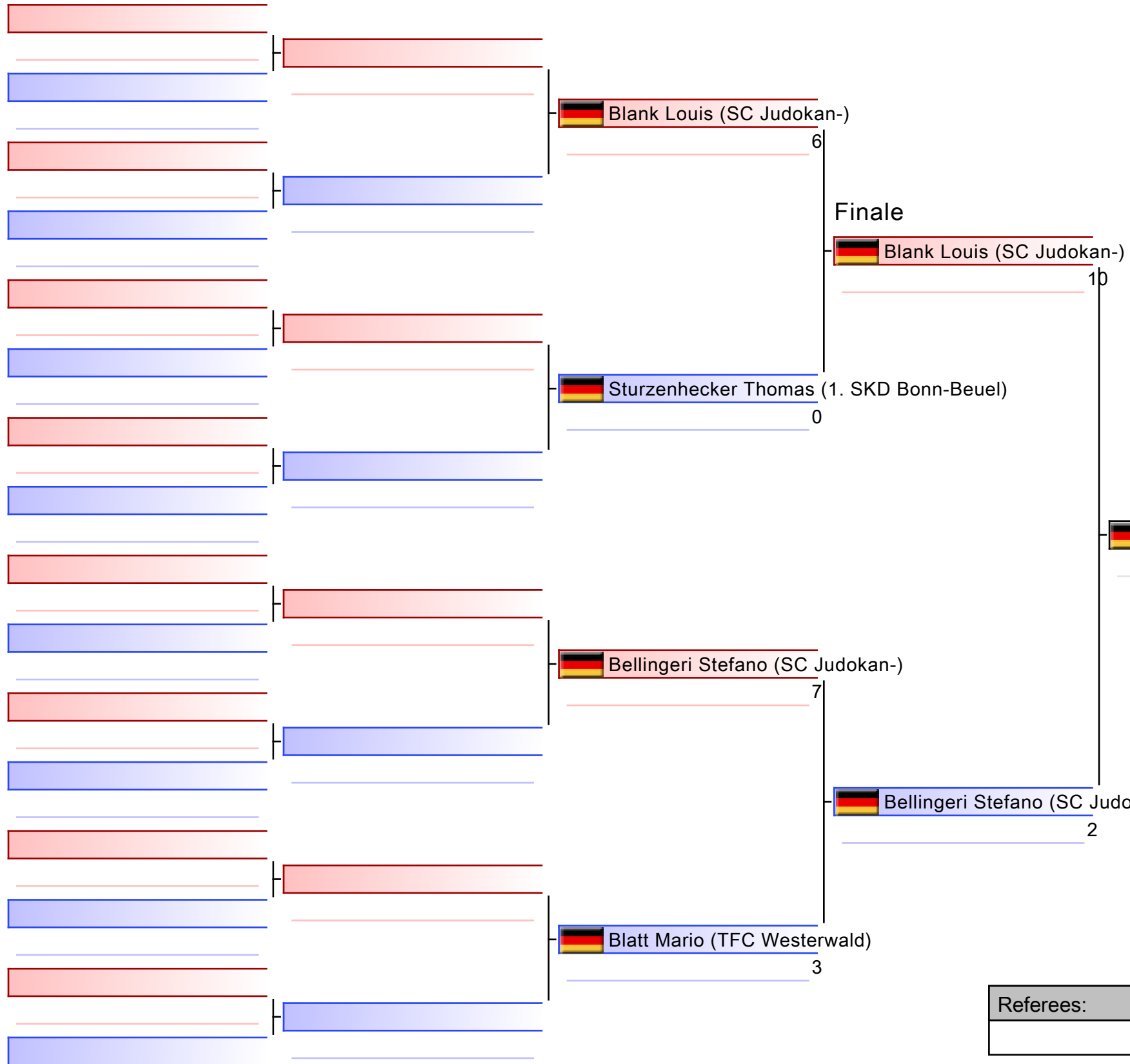

|   |
|---|
| 1. BLANK LOUIS (SC JUDOKAN-)                |
| 2. BELLINGERI STEFANO (SC JUDOKAN-)         |
| 3. STURZENHECKER THOMAS (1. SKD BONN-BEUEL) |
| 3. BLATT MARIO (TFC WESTERWALD)             |
|   |
|   |
|   |

|           |  |  |  |
|-----------|--|--|--|
| Referees: |  |  |  |
|           |  |  |  |

# Kumite Masterklasse Herren Ü55/Ü65 -80kg

Offene Landesmeisterschaft Hessen und Rheinland - Pfalz 2024

Tatami

Pool

1

(c)sportdata GmbH & Co KG 2000-2024 (2024-02-04 18:16) v 10.1.0 build 1 (2024-01-30 21:40 CET) Lizenz: Online\_Event\_ID-7816\_OffeneLandesmeisterschaftHessenundRheinlandPfalz2024 (expire 2024-02-18)

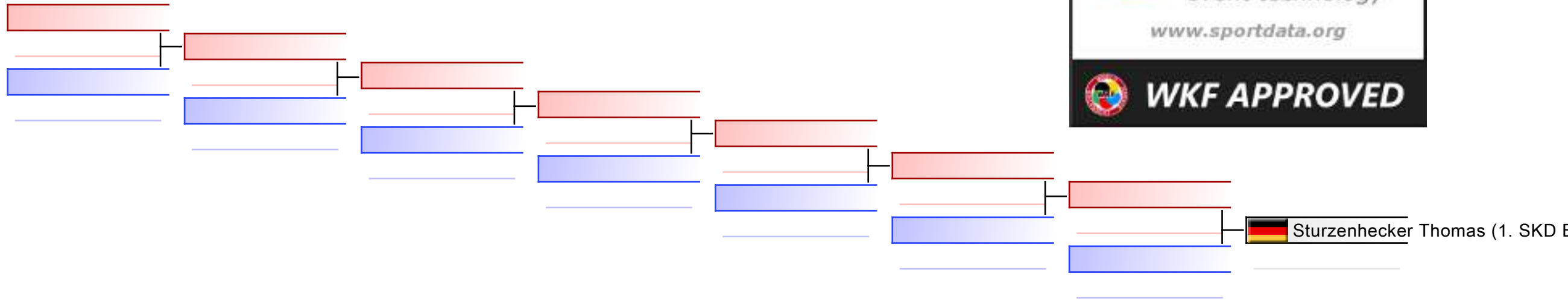

## TROSTRUNDE: (1)

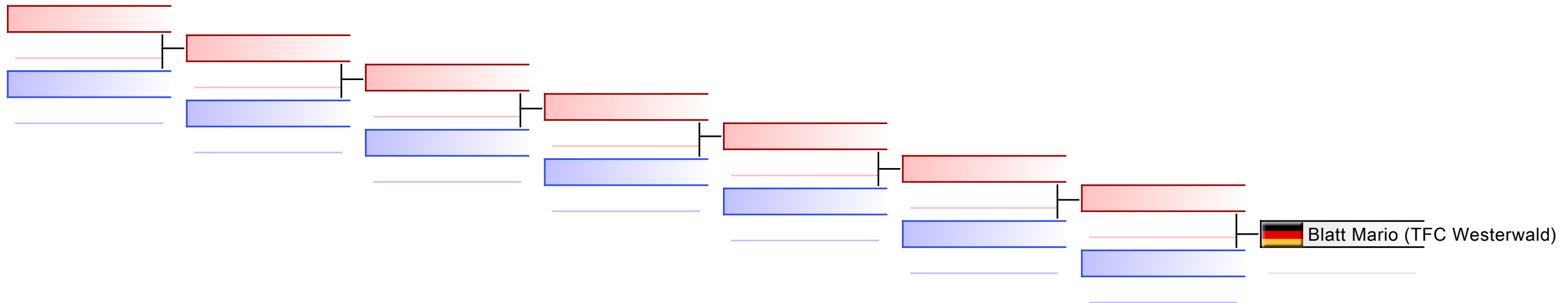

|           |  |  |  |  |  |  |  |
|-----------|--|--|--|--|--|--|--|
| Referees: |  |  |  |  |  |  |  |
|-----------|--|--|--|--|--|--|--|



Offene Landesmeisterschaft Hessen  
und Rheinland - Pfalz 2024 - 2024-02-03

Offizielle Ergebnisliste

| Kumite Masterklasse Herren Ü55/Ü65 -80kg |                      |   |   |               |
|--|----------------------|---|---|---------------|
| 1  | BLANK LOUIS          | SC JUDOKAN E.V.                           |  | GER - GERMANY |
| 2  | BELLINGERI STEFANO   | SC JUDOKAN E.V.                           |  | GER - GERMANY |
| 3  | STURZENHECKER THOMAS | 1. BONN-BEUELER SHOTOKAN KARATE DOJO E.V. |  | GER - GERMANY |
| 3  | BLATT MARIO          | TEAM FIGHTCLUB WESTERWALD                 |  | GER - GERMANY |

**KUMITE TEAM HERREN**  
**LEISTUNGSKLASSE/U21**



# Offene Landesmeisterschaft Hessen und Rheinland -..

## ENTRIES BY WEIGHT CATEGORY

### Kumite Team Herren Leistungsklasse/U21

As of 4 FEB 2024

| NOC Code | Gender | Name                 | Seeding |
|----------|--------|----------------------|---------|
| GER      | M      | Alkatep Ahmad        |         |
| GER      | M      | Azimi Massihullah    |         |
| GER      | M      | Bier Marvin          |         |
| GER      | M      | Egerland Marvin-Luca |         |
| GER      | M      | Eul Jan              |         |
| GER      | M      | Harisow Maxim        |         |
| GER      | M      | Hoffmann Jan         |         |
| GER      | M      | Mawardi Ahmad        |         |
| GER      | M      | Müller Elias         |         |
| GER      | M      | Schoppel Martin      |         |
| GER      | M      | Schäfer Timo Maria   |         |
| GER      | M      | Shepelev Marcel      |         |
| GER      | M      | Takzima Aymane       |         |
| GER      | M      | Thran Melvin         |         |



# Kumite Team Herren Leistungsklasse/U21

Offene Landesmeisterschaft Hessen und Rheinland - Pfalz 2024, Schulstraße 2, 69509 Mörlenbach, GER

2024-02-03

Tatami

2 15:35

Pool

1/1

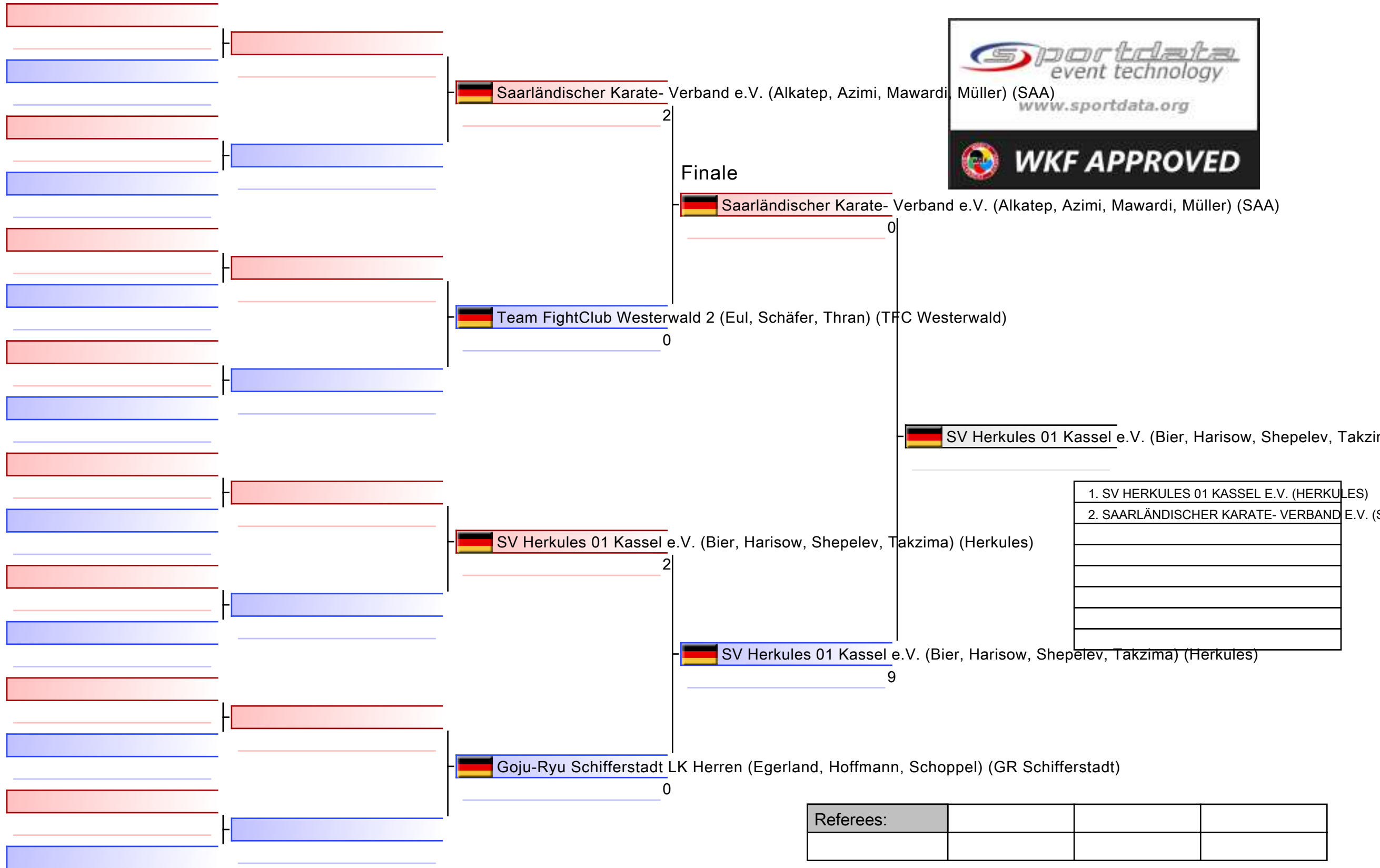



Offene Landesmeisterschaft Hessen  
und Rheinland - Pfalz 2024 - 2024-02-03

Offizielle Ergebnisliste

| Kumite Team Herren Leistungsklasse/U21 |   |   |   |               |  |
|--|---|---|---|---------------|--|
| 1                                      | SV HERKULES 01 KASSEL E.V.<br>- BIER MARVIN<br>- HARISOW MAXIM<br>- SHEPELEV MARCEL<br>- TAKZIMA AYMANE               | SV HERKULES 01<br>KASSEL E.V.             |  | GER - GERMANY |  |
| 2                                      | SAARLÄNDISCHER KARATE-<br>VERBAND E.V.<br>- MÜLLER ELIAS<br>- MAWARDI AHMAD<br>- ALKATEP AHMAD<br>- AZIMI MASSIHULLAH | SAARLÄNDISCHER<br>KARATE- VERBAND<br>E.V. |  | GER - GERMANY |  |

# LEISTUNGSKLASSE KATA DAMEN



# Offene Landesmeisterschaft Hessen und Rheinland -..

## ENTRIES BY WEIGHT CATEGORY

### Leistungsklasse Kata Damen

As of 4 FEB 2024

| NOC Code | Gender | Name                     | Seeding |
|----------|--------|--------------------------|---------|
| GER      | F      | Agte Sarah               |         |
| GER      | F      | Bosserdt Vanessa         |         |
| GER      | F      | Brand Kerstin            |         |
| GER      | F      | Dannenberg Christina     |         |
| GER      | F      | Dielmann Jessica         |         |
| GER      | F      | Durdevic Jasna           |         |
| GER      | F      | Faul Annika              |         |
| GER      | F      | Fellinger Anna Sophie    |         |
| GER      | F      | Florido Martins Lilliana |         |
| GER      | F      | Fredrich Julia           |         |
| GER      | F      | Griessel Carolina        |         |
| GER      | F      | Hebbel Patricia          |         |
| GER      | F      | Kharsa Maya              |         |
| GER      | F      | Koch Jacqueline          |         |
| GER      | F      | Kurz Ronya               |         |
| GER      | F      | Kölsch Sarah             |         |
| GER      | F      | Mack Ally                |         |
| GER      | F      | Nguyen Carina Ngoc Vy    |         |
| GER      | F      | Ohnesorge Rebecca        |         |
| GER      | F      | Parkhomenko Yewa         |         |
| GER      | F      | Schopmann Annika         |         |
| GER      | F      | Schwalbach Nina          |         |
| GER      | F      | Stang Rabea              |         |
| GER      | F      | Sternberger Alena        |         |

# Leistungsklasse Kata Damen

Offene Landesmeisterschaft Hessen und Rheinland - Pfalz 2024, Schulstraße 2, 69509 Mörlenbach, GER

2024-02-03

Tatami  
1 09:15

Pool  
1/2

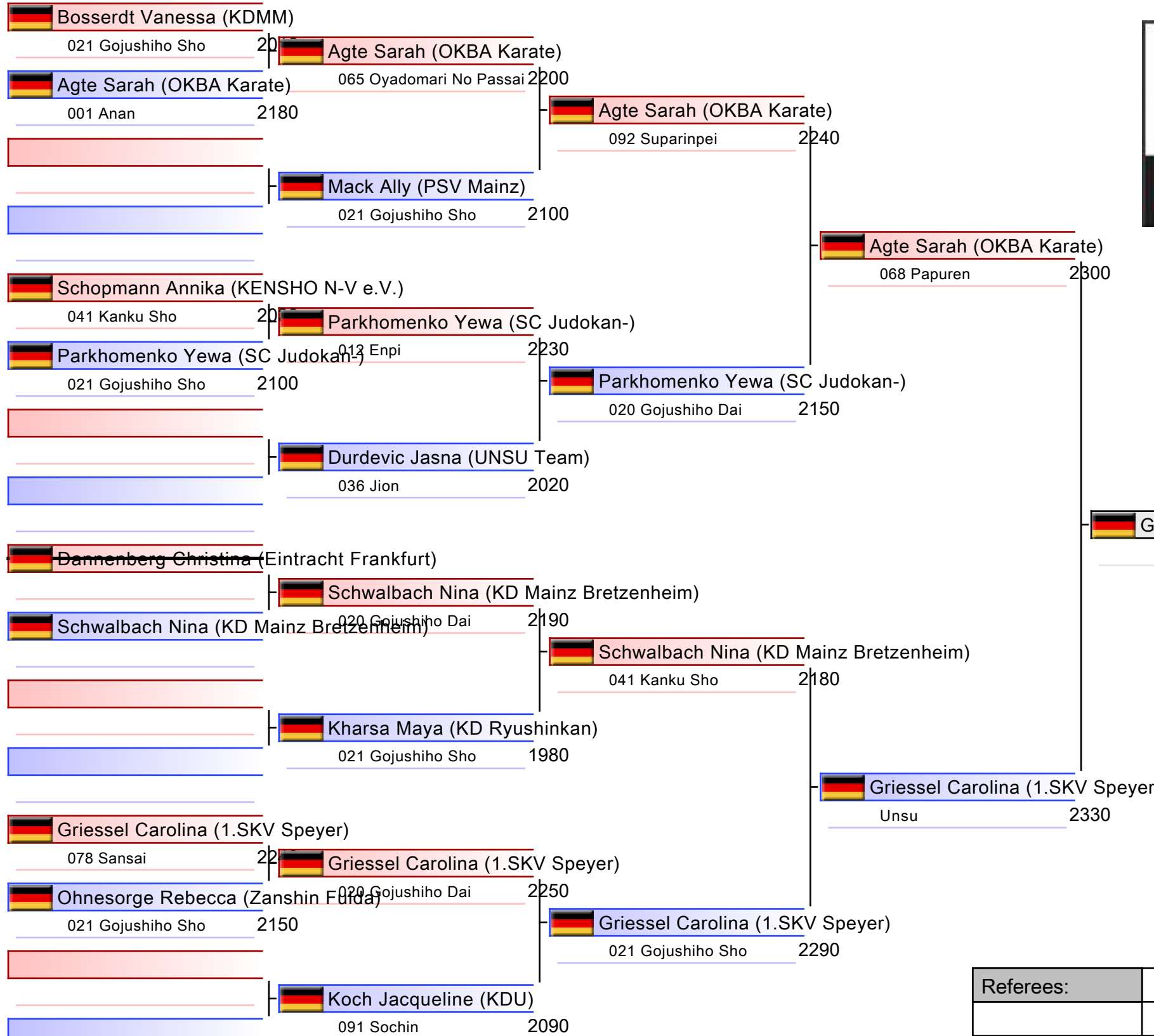

- |   |
|---|
| 1. FAUL ANNIKA (IGS BUDOKAN KL)                 |
| 2. GRIESEL CAROLINA (1.SKV SPEYER)              |
| 3. AGTE SARAH (OKBA KARATE)                     |
| 3. KURZ RONYA (SAA)                             |
| 5. SCHWALBACH NINA (KD MAINZ BRETZENHEIM)       |
| 5. DIELMANN JESSICA (SC JUDOKAN-)               |
| 7. OHNESORGE REBECCA (ZANSHIN FULDA)            |
| 7. FELLINGER ANNA SOPHIE (KD MAINZ BRETZENHEIM) |

|           |  |  |  |
|-----------|--|--|--|
| Referees: |  |  |  |
|           |  |  |  |

# Leistungsklasse Kata Damen

Offene Landesmeisterschaft Hessen und Rheinland - Pfalz 2024, Schulstraße 2, 69509 Mörlenbach, GER

2024-02-03

Tatami  
2 09:15

Pool  
2/2

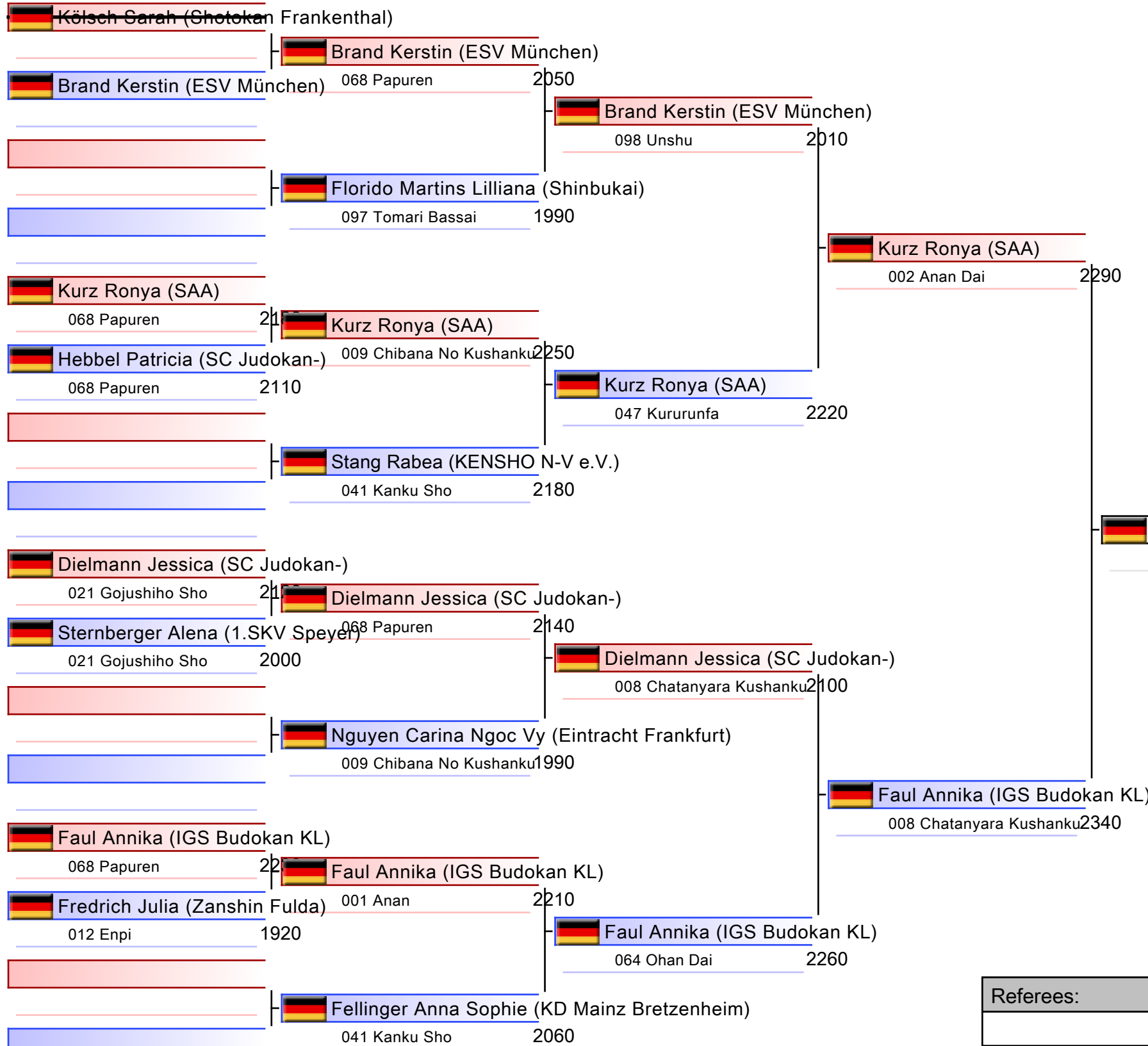

- |   |
|---|
| 1. FAUL ANNIKA (IGS BUDOKAN KL)                 |
| 2. GRIESEL CAROLINA (1.SKV SPEYER)              |
| 3. AGTE SARAH (OKBA KARATE)                     |
| 3. KURZ RONYA (SAA)                             |
| 5. SCHWALBACH NINA (KD MAINZ BRETZENHEIM)       |
| 5. DIELMANN JESSICA (SC JUDOKAN-)               |
| 7. OHNESORGE REBECCA (ZANSHIN FULDA)            |
| 7. FELLINGER ANNA SOPHIE (KD MAINZ BRETZENHEIM) |

|           |  |  |  |
|-----------|--|--|--|
| Referees: |  |  |  |
|           |  |  |  |

# Poolieger-Leistungsklasse Kata Damen

Offene Landesmeisterschaft Hessen und Rheinland - Pfalz 2024, Schulstraße 2, 69509 Mörlenbach, GER

Tatami

Pool

1/1

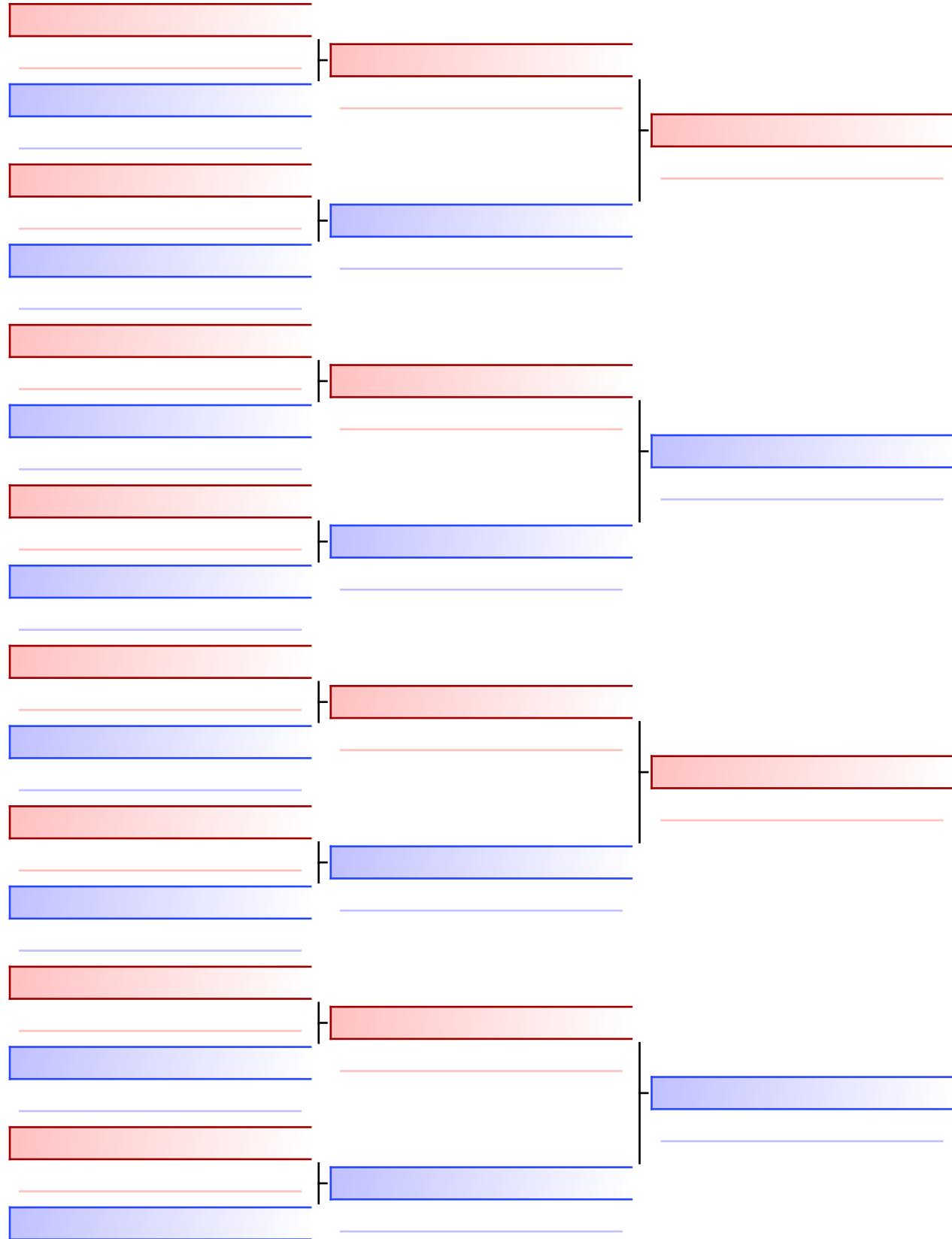

## Finale

Griessel Carolina (1.SKV Speyer)  
015 Gankaku 4040

Faul Annika (IGS Budokan KL)

Faul Annika (IGS Budokan KL)  
009 Chibana No Kushanku4060

- |   |
|---|
| 1. FAUL ANNIKA (IGS BUDOKAN KL)                 |
| 2. GRIESEL CAROLINA (1.SKV SPEYER)              |
| 3. AGTE SARAH (OKBA KARATE)                     |
| 3. KURZ RONYA (SAA)                             |
| 5. SCHWALBACH NINA (KD MAINZ BRETZENHEIM)       |
| 5. DIELMANN JESSICA (SC JUDOKAN-)               |
| 7. OHNESORGE REBECCA (ZANSHIN FULDA)            |
| 7. FELLINGER ANNA SOPHIE (KD MAINZ BRETZENHEIM) |

|           |  |  |  |
|-----------|--|--|--|
| Referees: |  |  |  |
|           |  |  |  |

# Leistungsklasse Kata Damen

Offene Landesmeisterschaft Hessen und Rheinland - Pfalz 2024

2024-02-03

Tatami  
1 10:20

Pool  
1,2

(c)sportdata GmbH & Co KG 2000-2024 (2024-02-04 18:16) v 10.1.0 build 1 (2024-01-30 21:40 CET) Lizenz: Online\_Event\_ID-7816\_OffeneLandesmeisterschaftHessenundRheinlandPfalz2024 (expire 2024-02-18)

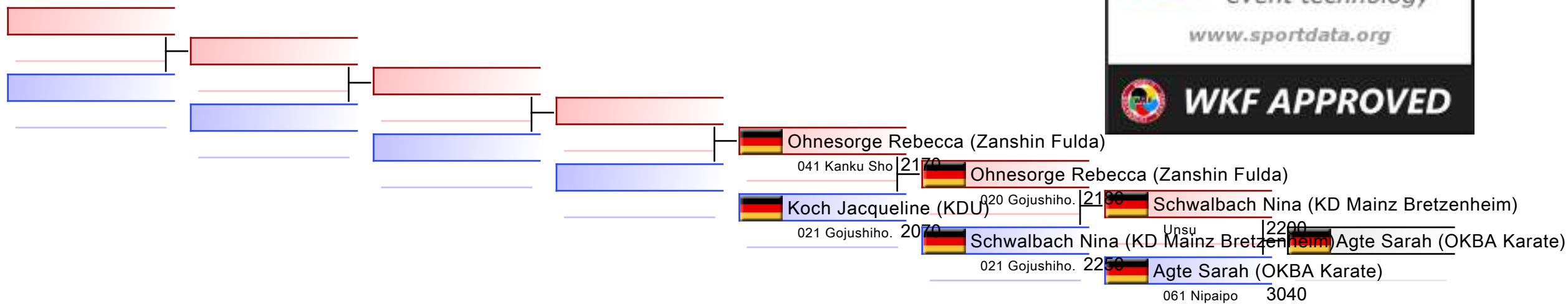

## TROSTRUNDE: (1,2)

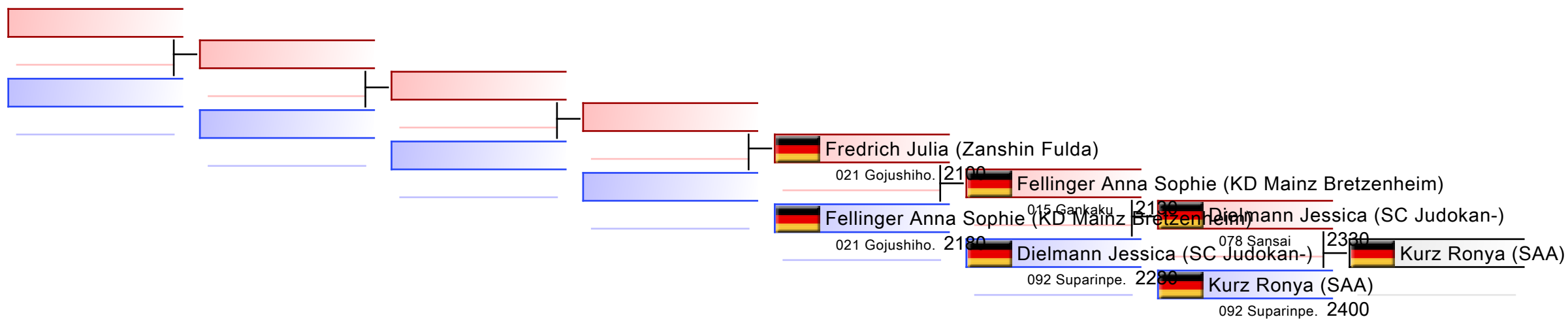

|           |  |  |  |  |  |  |  |
|-----------|--|--|--|--|--|--|--|
| Referees: |  |  |  |  |  |  |  |
|-----------|--|--|--|--|--|--|--|





Offene Landesmeisterschaft Hessen  
und Rheinland - Pfalz 2024 - 2024-02-03

Offizielle Ergebnisliste

| Leistungsklasse Kata Damen |                       |   |  |               |  |
|----------------------------|-----------------------|---|--|---------------|--|
| 1                          | FAUL ANNIKA           | IGS BUDOKAN<br>KAISERSLAUTERN             |  | GER - GERMANY |  |
| 2                          | GRIESEL CAROLINA      | 1. SHOTOKAN<br>KARATE VEREIN<br>SPEYER    |  | GER - GERMANY |  |
| 3                          | AGTE SARAH            | SKO WISMAR E.V.                           |  | GER - GERMANY |  |
| 3                          | KURZ RONYA            | SAARLÄNDISCHER<br>KARATE- VERBAND<br>E.V. |  | GER - GERMANY |  |
| 5                          | SCHWALBACH NINA       | KARATE DOJO MAINZ<br>BRETZENHEIM E.V      |  | GER - GERMANY |  |
| 5                          | DIELMANN JESSICA      | SC JUDOKAN E.V.                           |  | GER - GERMANY |  |
| 7                          | OHNESORGE REBECCA     | ZANSHIN GRÜN-<br>WEISS FULDA              |  | GER - GERMANY |  |
| 7                          | FELLINGER ANNA SOPHIE | KARATE DOJO MAINZ<br>BRETZENHEIM E.V      |  | GER - GERMANY |  |
| 9                          | KOCH JACQUELINE       | SV UNTERROT                               |  | GER - GERMANY |  |
| 9                          | FREDRICH JULIA        | ZANSHIN GRÜN-<br>WEISS FULDA              |  | GER - GERMANY |  |

# LEISTUNGSKLASSE KATA HERRE



# Offene Landesmeisterschaft Hessen und Rheinland -..

## ENTRIES BY WEIGHT CATEGORY

### Leistungsklasse Kata Herren

As of 4 FEB 2024

| NOC Code | Gender | Name                     | Seeding |
|----------|--------|--------------------------|---------|
| GER      | M      | Clemens Jan              |         |
| GER      | M      | Gustavus Marius          |         |
| GER      | M      | Hadizadeh Julian Fabrice |         |
| GER      | M      | Hecht Markus             |         |
| GER      | M      | Heine Moritz             |         |
| GER      | M      | Höft Hannes              |         |
| GER      | M      | Kheiri-Ahvazi Nima       |         |
| GER      | M      | Liedy Jonas-Pascal       |         |
| GER      | M      | Preisendörfer Kiran      |         |
| GER      | M      | Thierolf Julian          |         |
| GER      | M      | Ziza Rayan               |         |

# Leistungsklasse Kata Herren

Offene Landesmeisterschaft Hessen und Rheinland - Pfalz 2024, Schulstraße 2, 69509 Mörlenbach, GER

2024-02-03

Tatami  
3 09:15

Pool  
1/2

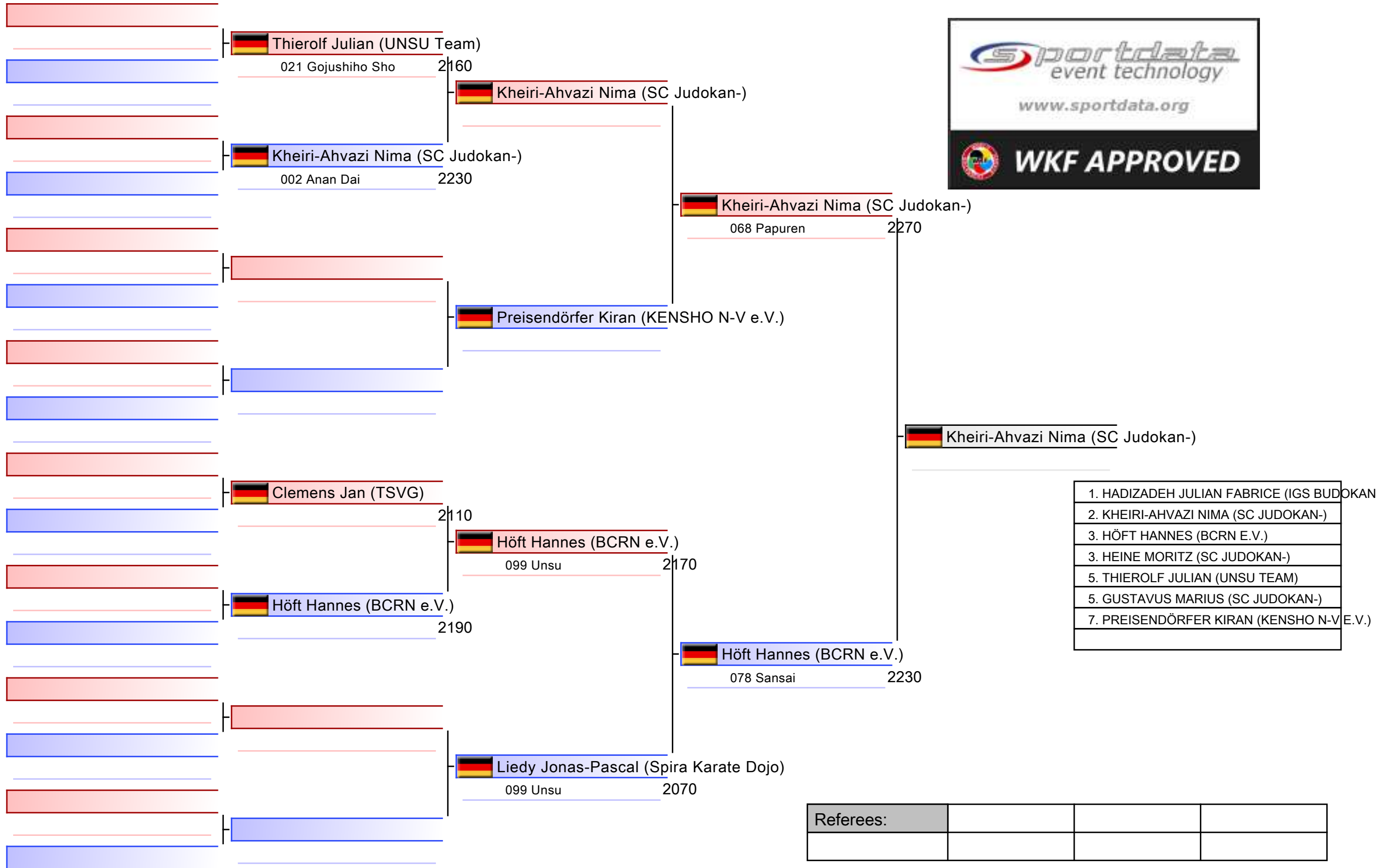

# Leistungsklasse Kata Herren

Offene Landesmeisterschaft Hessen und Rheinland - Pfalz 2024, Schulstraße 2, 69509 Mörlenbach, GER

2024-02-03

Tatami  
4 09:15

Pool  
2/2

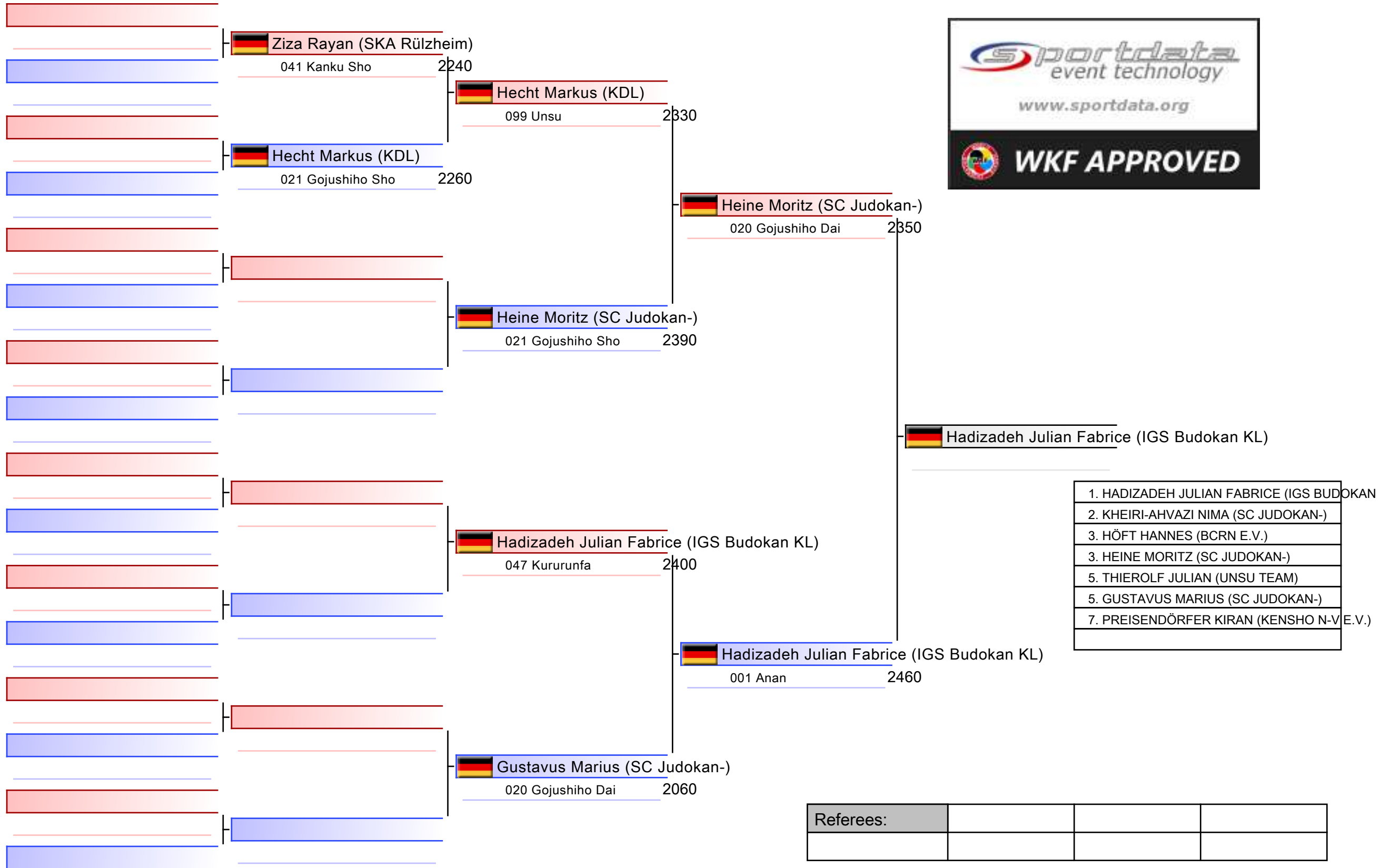

1. HADIZADEH JULIAN FABRICE (IGS BUDOKAN KL)
2. KHEIRI-AHVAZI NIMA (SC JUDOKAN-)
3. HÖFT HANNES (BCRN E.V.)
3. HEINE MORITZ (SC JUDOKAN-)
5. THIEROLF JULIAN (UNSU TEAM)
5. GUSTAVUS MARIUS (SC JUDOKAN-)
7. PREISENDÖRFER KIRAN (KENSHO N-V E.V.)

# Poolieger-Leistungsklasse Kata Herren

Offene Landesmeisterschaft Hessen und Rheinland - Pfalz 2024, Schulstraße 2, 69509 Mörlenbach, GER

Tatami

Pool

1/1

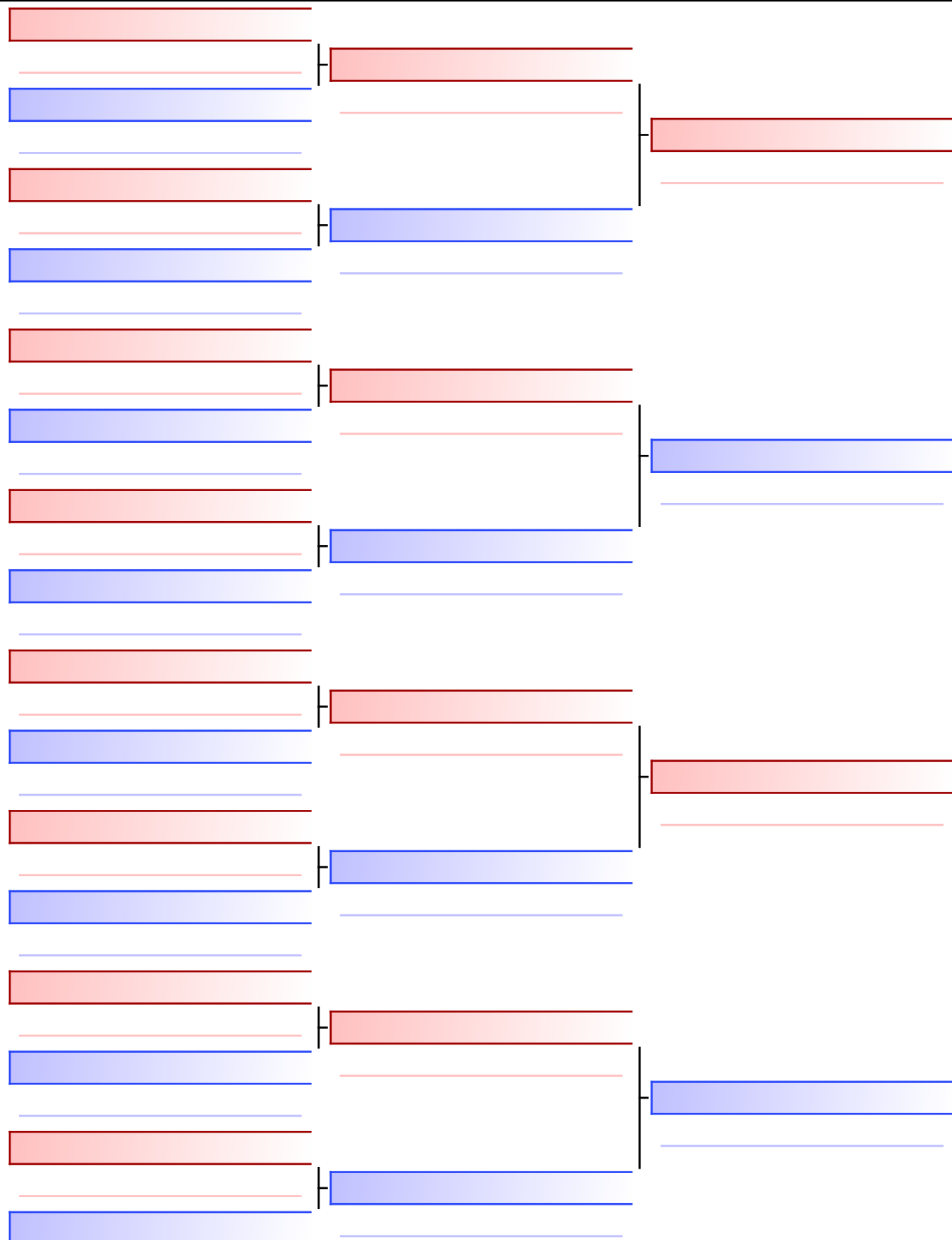

## Finale

Kheiri-Ahvazi Nima (SC Judokan-)

064 Ohan Dai 4170

Hadizadeh Julian Fabrice (IGS Budokan KL)

Hadizadeh Julian Fabrice (IGS Budokan KL)

068 Papuren 4190

- |  |
|--|
| 1. HADIZADEH JULIAN FABRICE (IGS BUDOKAN KL) |
| 2. KHEIRI-AHVAZI NIMA (SC JUDOKAN-)          |
| 3. HÖFT HANNES (BCRN E.V.)                   |
| 3. HEINE MORITZ (SC JUDOKAN-)                |
| 5. THIEROLF JULIAN (UNSU TEAM)               |
| 5. GUSTAVUS MARIUS (SC JUDOKAN-)             |
| 7. PREISENDÖRFER KIRAN (KENSHO N-V E.V.)     |

|           |  |  |  |
|-----------|--|--|--|
| Referees: |  |  |  |
|           |  |  |  |

# Leistungsklasse Kata Herren

Offene Landesmeisterschaft Hessen und Rheinland - Pfalz 2024

2024-02-03

Tatami  
3 09:45

Pool  
1,2

(c)sportdata GmbH & Co KG 2000-2024 (2024-02-04 18:16) v 10.1.0 build 1 (2024-01-30 21:40 CET) Lizenz: Online\_Event\_ID-7816\_OffeneLandesmeisterschaftHessenundRheinlandPfalz2024 (expire 2024-02-18)

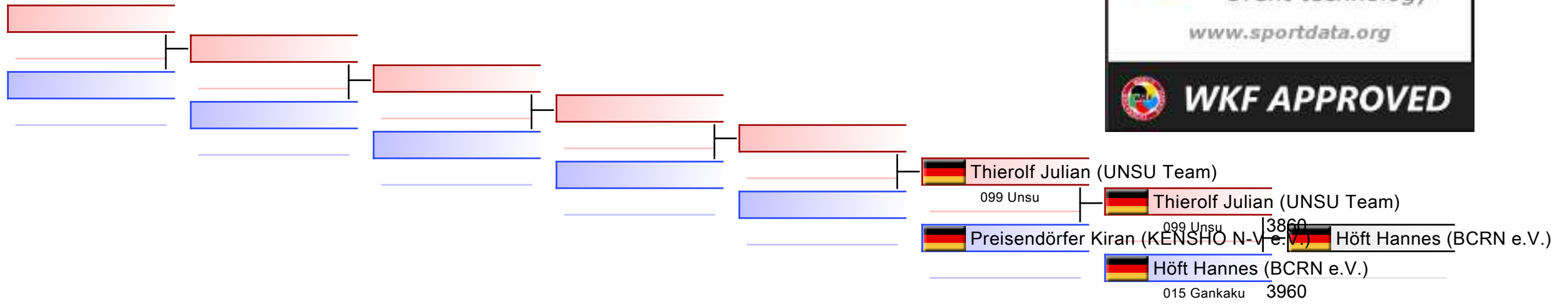

## TROSTRUNDE: (1,2)

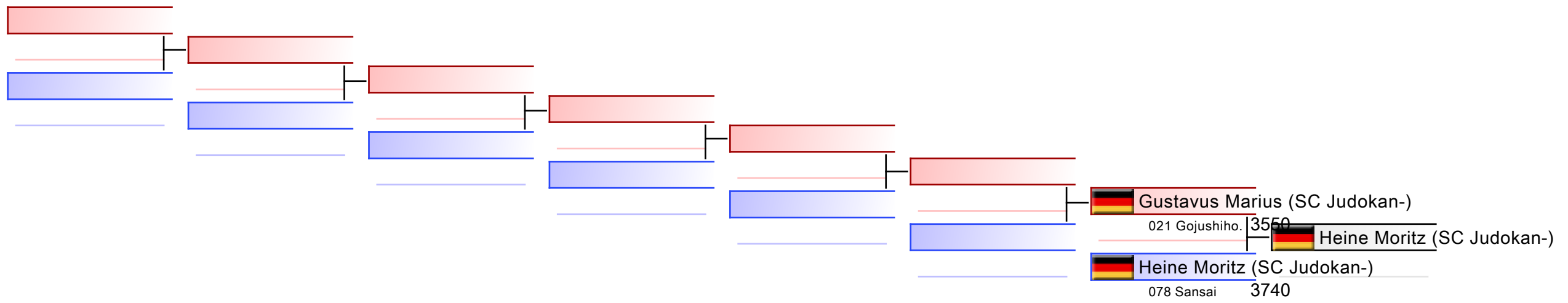

|           |  |  |  |  |  |  |  |
|-----------|--|--|--|--|--|--|--|
| Referees: |  |  |  |  |  |  |  |
|-----------|--|--|--|--|--|--|--|



Offene Landesmeisterschaft Hessen  
und Rheinland - Pfalz 2024 - 2024-02-03

Offizielle Ergebnisliste

| Leistungsklasse Kata Herren |                          |                                    |   |               |  |
|-----------------------------|--------------------------|------------------------------------|---|---------------|--|
| 1                           | HADIZADEH JULIAN FABRICE | IGS BUDOKAN<br>KAISERSLAUTERN      |  | GER - GERMANY |  |
| 2                           | KHEIRI-AHVAZI NIMA       | SC JUDOKAN E.V.                    |  | GER - GERMANY |  |
| 3                           | HÖFT HANNES              | BUDOCLUB RHEIN-<br>NECKAR E.V.     |  | GER - GERMANY |  |
| 3                           | HEINE MORITZ             | SC JUDOKAN E.V.                    |  | GER - GERMANY |  |
| 5                           | THIEROLF JULIAN          | SV UNSU KARATE<br>MÖMLINGEN E.V.   |  | GER - GERMANY |  |
| 5                           | GUSTAVUS MARIUS          | SC JUDOKAN E.V.                    |  | GER - GERMANY |  |
| 7                           | PREISENDÖRFER KIRAN      | KENSHO<br>NEUKIRCHEN-VLUYN<br>E.V. |  | GER - GERMANY |  |





LEISTUNGSKLASSE KATA TEAM  
MÄNNLICH



# Offene Landesmeisterschaft Hessen und Rheinland -..

## ENTRIES BY WEIGHT CATEGORY

### Leistungsklasse Kata Team männlich

As of 4 FEB 2024

| NOC Code | Gender | Name                 | Seeding |
|----------|--------|----------------------|---------|
| GER      | M      | Kienle Jürgen        |         |
| GER      | M      | Küster Niklas        |         |
| GER      | M      | Münch Fabio          |         |
| GER      | M      | Ochs Wilfried        |         |
| GER      | M      | Sack Klaus-Dieter    |         |
| GER      | M      | Wankmüller Janne-Rik |         |

# Leistungsklasse Kata Team männlich

Offene Landesmeisterschaft Hessen und Rheinland - Pfalz 2024, Schulstraße 2, 69509 Mörlenbach, GER

Tatami

Pool

1/1

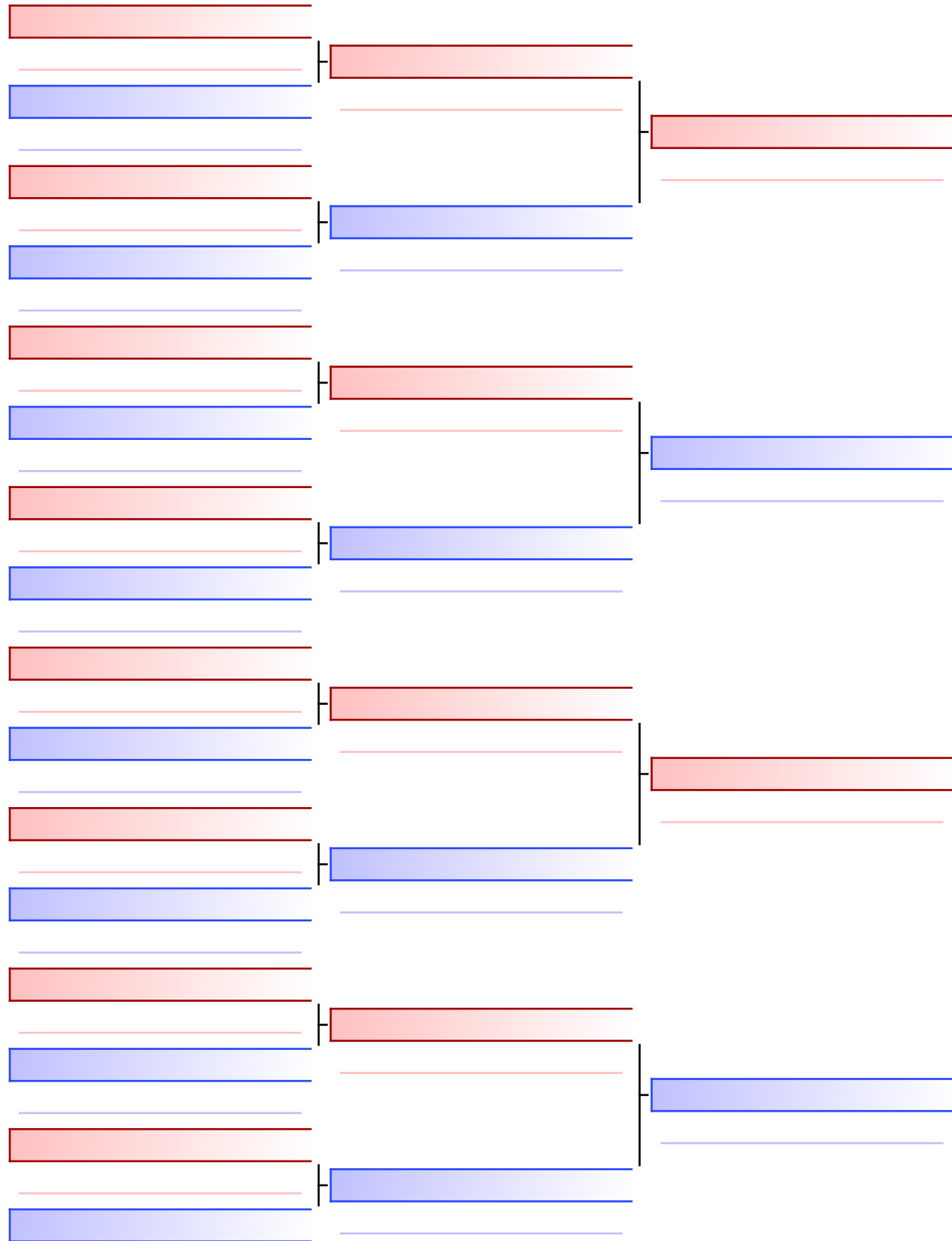

## Finale

**Katateam PSV Mainz (Kienle, Ochs, Sack) (PSV Mainz)**

060 Nijushiho 3710

**Katateam PSV Mainz (Kienle, Ochs, Sack) (PSV Mainz)**

**SKA Rülzheim 1 (Küster, Münch, Wankmüller) (SKA Rülzheim)**

029 Heian Godan 3580

1. KATATEAM PSV MAINZ (PSV MAINZ)

2. SKA RÜLZHEIM 1 (SKA RÜLZHEIM)

|           |  |  |  |
|-----------|--|--|--|
| Referees: |  |  |  |
|           |  |  |  |



Offene Landesmeisterschaft Hessen  
und Rheinland - Pfalz 2024 - 2024-02-03

Offizielle Ergebnisliste

| Leistungsklasse Kata Team männlich |   |   |   |               |
|------------------------------------|---|---|---|---------------|
| 1                                  | KATATEAM PSV MAINZ<br>- SACK KLAUS-DIETER<br>- OCHS WILFRIED<br>- KIENLE JÜRGEN | POLIZEI<br>SPORTVEREIN<br>MAINZ E.V.              |  | GER - GERMANY |
| 2                                  | SKA RÜLZHEIM 1<br>- KÜSTER NIKLAS<br>- MÜNCH FABIO<br>- WANKMÜLLER JANNE-RIK    | SHOTOKAN<br>RYU KARATE<br>DO AKADEMIE<br>RÜLZHEIM |  | GER - GERMANY |



LEISTUNGSKLASSE KATA TEAM  
WEIBLICH



# Offene Landesmeisterschaft Hessen und Rheinland -..

## ENTRIES BY WEIGHT CATEGORY

### Leistungsklasse Kata Team weiblich

As of 4 FEB 2024

| NOC Code | Gender | Name              | Seeding |
|----------|--------|-------------------|---------|
| GER      | F      | Faul Annika       |         |
| GER      | F      | Leuckel Melanie   |         |
| GER      | F      | Mack Katharina    |         |
| GER      | F      | Nguyen Carina     |         |
| GER      | F      | Nowicki Iris      |         |
| GER      | F      | Poh Nadine Sophie |         |

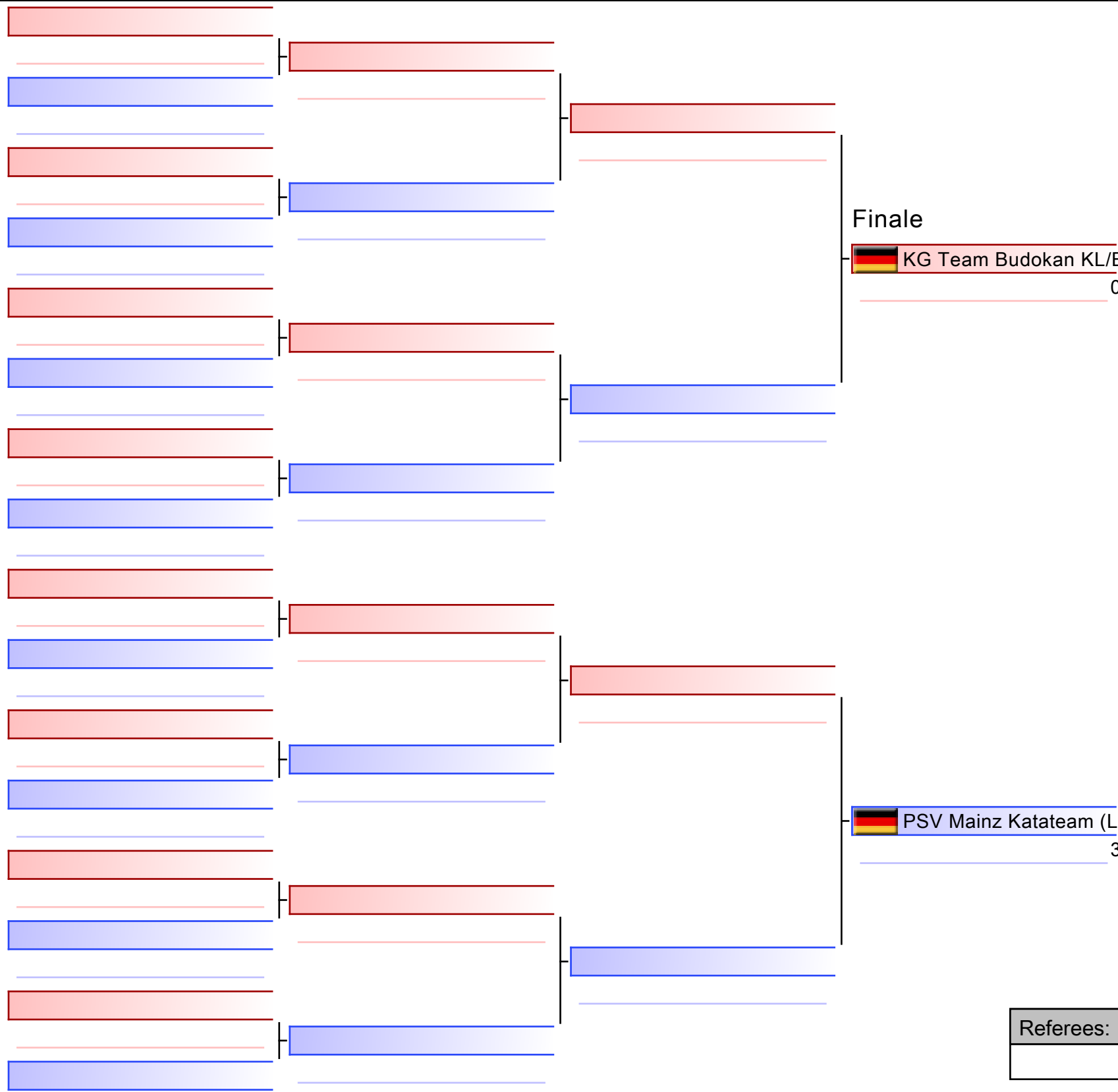

Finale

KG Team Budokan KL/Eintracht FFM (Faul, Nguyen, Poh) (IGS Budokan KL)

0

PSV Mainz Katateam (Leuckel, Mack, Nowicki) (PSV Mainz)

|   |
|---|
| 1. PSV MAINZ KATATEAM (PSV MAINZ)         |
| 2. KG TEAM BUDOKAN KL/EINTRACHT FFM (IGS) |
|   |
|   |
|   |
|   |
|   |
|   |

PSV Mainz Katateam (Leuckel, Mack, Nowicki) (PSV Mainz)

3600

|           |  |  |  |
|-----------|--|--|--|
| Referees: |  |  |  |
|           |  |  |  |



Offene Landesmeisterschaft Hessen  
und Rheinland - Pfalz 2024 - 2024-02-03

Offizielle Ergebnisliste

| Leistungsklasse Kata Team weiblich |   |                                      |   |               |
|------------------------------------|---|--------------------------------------|---|---------------|
| 1                                  | PSV MAINZ KATATEAM<br>- LEUCKEL MELANIE<br>- NOWICKI IRIS<br>- MACK KATHARINA                   | POLIZEI<br>SPORTVEREIN<br>MAINZ E.V. |  | GER - GERMANY |
| 2                                  | KG TEAM BUDOKAN KL/<br>EINTRACHT FFM<br>- FAUL ANNIKA<br>- NGUYEN CARINA<br>- POH NADINE_SOPHIE | IGS BUDOKAN<br>KAISERSLAUTERN        |  | GER - GERMANY |



LEISTUNGSKLASSE KUMITE +68  
WEIBLICH



# Offene Landesmeisterschaft Hessen und Rheinland -..

## ENTRIES BY WEIGHT CATEGORY

Leistungsklasse Kumite +68 kg weiblich

As of 4 FEB 2024

| NOC Code | Gender | Name               | Seeding |
|----------|--------|--------------------|---------|
| GER      | F      | Mujezinovic Samira |         |
| GER      | F      | Scherer Johanna    |         |

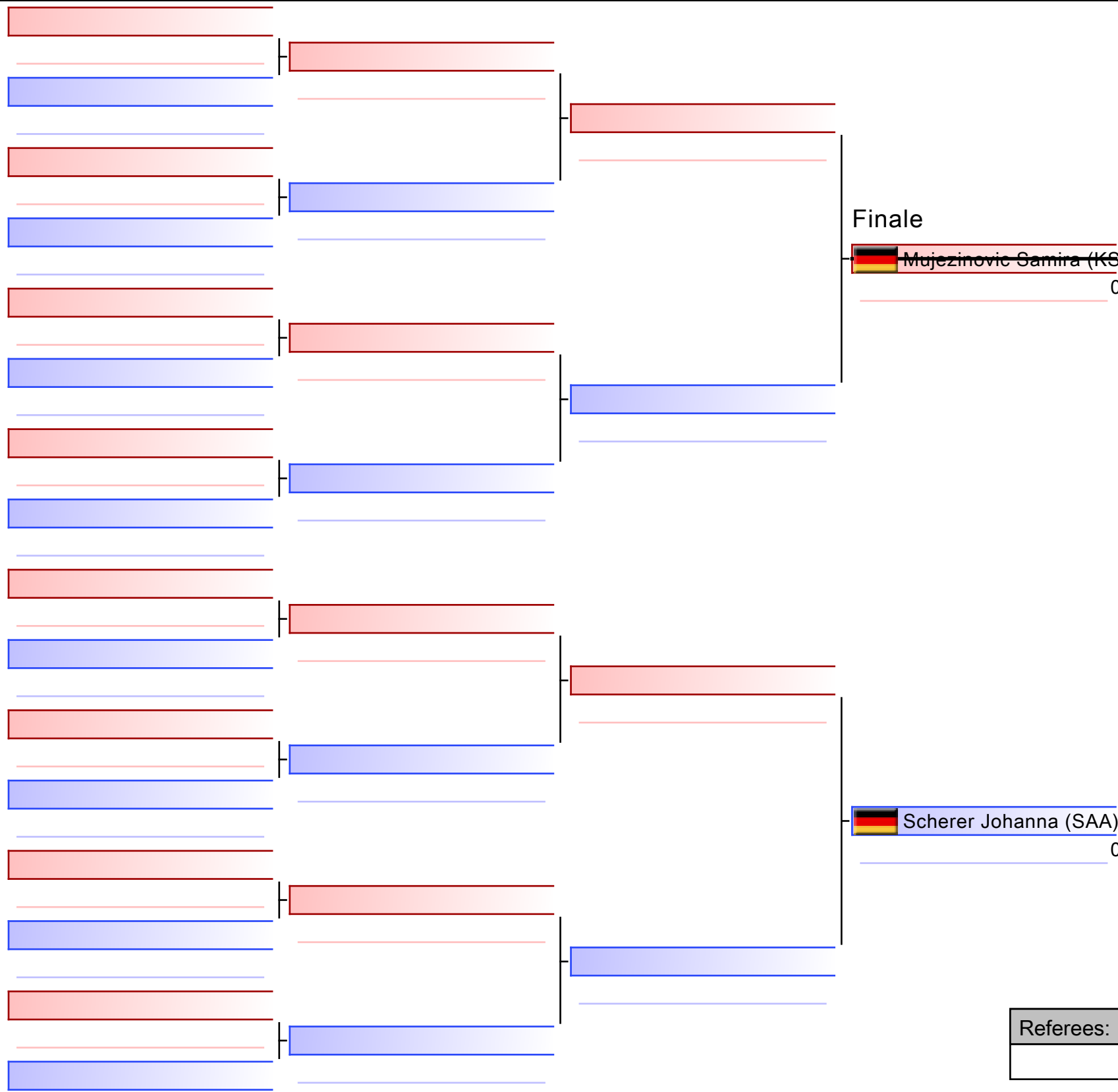

Finale

Mujezinovic Samira (KSC Puderbach)

0

Scherer Johanna (SAA)

Scherer Johanna (SAA)

0

|                          |
|--------------------------|
| 1. SCHERER JOHANNA (SAA) |
|                          |
|                          |
|                          |
|                          |
|                          |
|                          |
|                          |

|           |  |  |  |
|-----------|--|--|--|
| Referees: |  |  |  |
|           |  |  |  |



Offene Landesmeisterschaft Hessen  
und Rheinland - Pfalz 2024 - 2024-02-03

Offizielle Ergebnisliste

| Leistungsklasse Kumite +68 kg weiblich |                 |   |   |               |
|--|-----------------|---|---|---------------|
| 1                                      | SCHERER JOHANNA | SAARLÄNDISCHER<br>KARATE- VERBAND<br>E.V. |  | GER - GERMANY |



LEISTUNGSKLASSE KUMITE +84  
MÄNNLICH



# Offene Landesmeisterschaft Hessen und Rheinland -..

## ENTRIES BY WEIGHT CATEGORY

Leistungsklasse Kumite +84 kg männlich

As of 4 FEB 2024

| NOC Code | Gender | Name            | Seeding |
|----------|--------|-----------------|---------|
| GER      | M      | Eck Benjamin    |         |
| GER      | M      | Haubrich Tim    |         |
| GER      | M      | Krämer Jochen   |         |
| GER      | M      | Müller Elias    |         |
| GER      | M      | Omidi Behzad    |         |
| GER      | M      | Shepelev Marcel |         |

# Leistungsklasse Kumite +84 kg männlich

Offene Landesmeisterschaft Hessen und Rheinland - Pfalz 2024, Schulstraße 2, 69509 Mörlenbach, GER

2024-02-03

Tatami  
5 14:10

Pool  
1/1

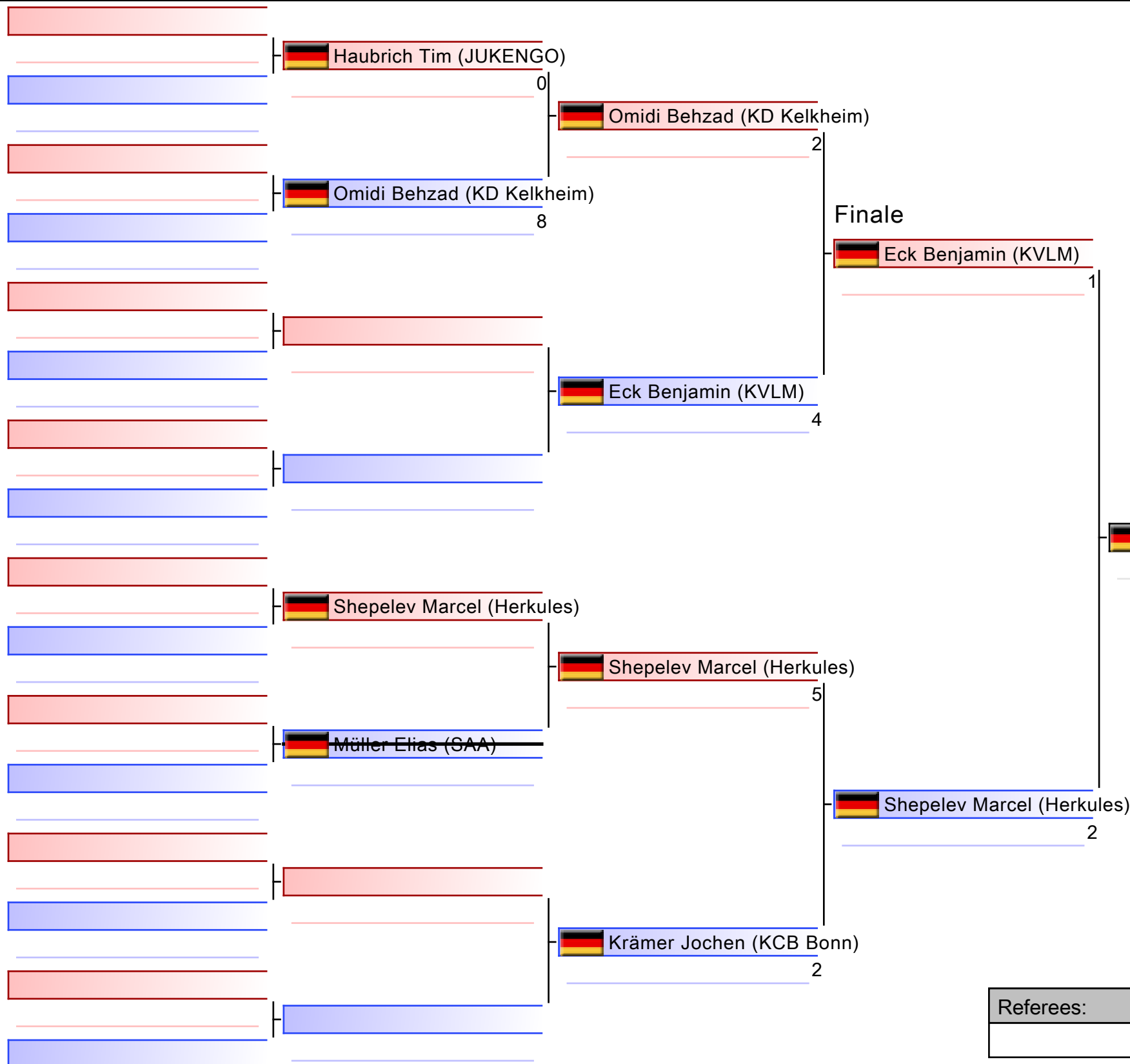

|                               |
|-------------------------------|
| 1. SHEPELEV MARCEL (HERKULES) |
| 2. ECK BENJAMIN (KVLM)        |
| 3. OMIDI BEHZAD (KD KELKHEIM) |
| 3. KRÄMER JOCHEN (KCB BONN)   |
|                               |
|                               |
|                               |

|           |  |  |  |
|-----------|--|--|--|
| Referees: |  |  |  |
|           |  |  |  |

# Leistungsklasse Kumite +84 kg männlich

Offene Landesmeisterschaft Hessen und Rheinland - Pfalz 2024

2024-02-03

Tatami  
5 14:35

Pool  
1

(c)sportdata GmbH & Co KG 2000-2024 (2024-02-04 18:16) v 10.1.0 build 1 (2024-01-30 21:40 CET) Lizenz: Online\_Event\_ID-7816\_OffeneLandesmeisterschaftHessenundRheinlandPfalz2024 (expire 2024-02-18)

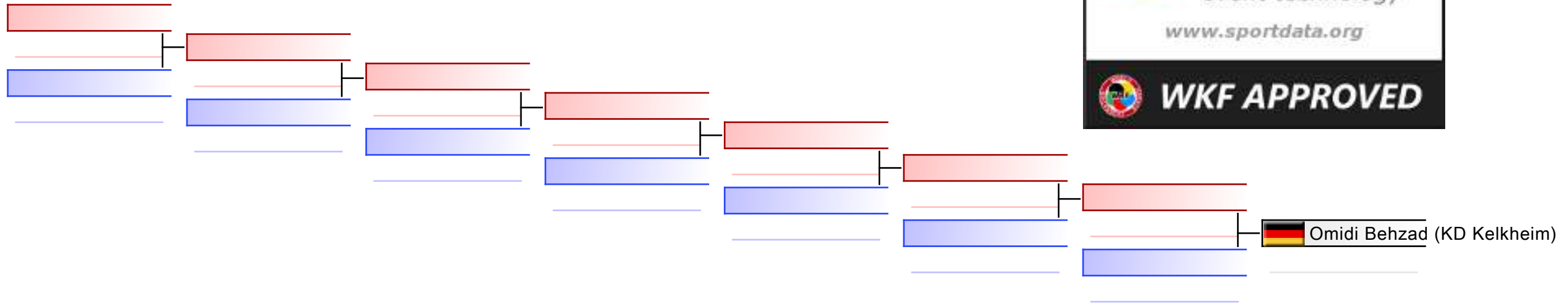

## TROSTRUNDE: (1)

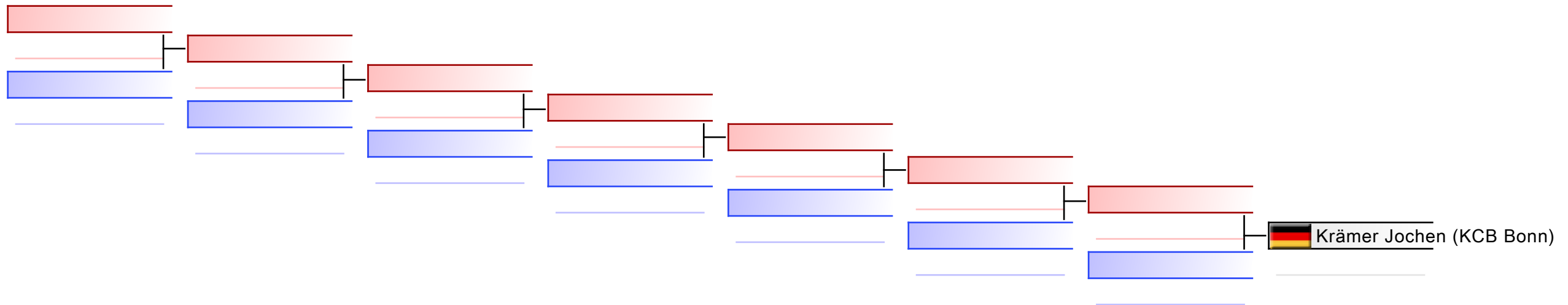

|           |  |  |  |  |  |  |  |
|-----------|--|--|--|--|--|--|--|
| Referees: |  |  |  |  |  |  |  |
|-----------|--|--|--|--|--|--|--|





Offene Landesmeisterschaft Hessen  
und Rheinland - Pfalz 2024 - 2024-02-03

Offizielle Ergebnisliste

| Leistungsklasse Kumite +84 kg männlich |                 |                               |   |               |
|--|-----------------|-------------------------------|---|---------------|
| 1                                      | SHEPELEV MARCEL | SV HERKULES 01<br>KASSEL E.V. |  | GER - GERMANY |
| 2                                      | ECK BENJAMIN    | KV LIMBURG                    |  | GER - GERMANY |
| 3                                      | OMIDI BEHZAD    | KARATE-DOJO<br>KELKHEIM E.V.  |  | GER - GERMANY |
| 3                                      | KRÄMER JOCHEN   | KARATE CLUB<br>BUSHIDO BONN   |  | GER - GERMANY |

LEISTUNGSKLASSE KUMITE -50 kg  
WEIBLICH



# Offene Landesmeisterschaft Hessen und Rheinland -..

## ENTRIES BY WEIGHT CATEGORY

Leistungsklasse Kumite -50 kg weiblich

As of 4 FEB 2024

| NOC Code | Gender | Name             | Seeding |
|----------|--------|------------------|---------|
| GER      | F      | Brettnacher Lara |         |
| GER      | F      | Reis Nele        |         |

# Leistungsklasse Kumite -50 kg weiblich

Offene Landesmeisterschaft Hessen und Rheinland - Pfalz 2024, Schulstraße 2, 69509 Mörlenbach, GER

Tatami

Pool

1/1

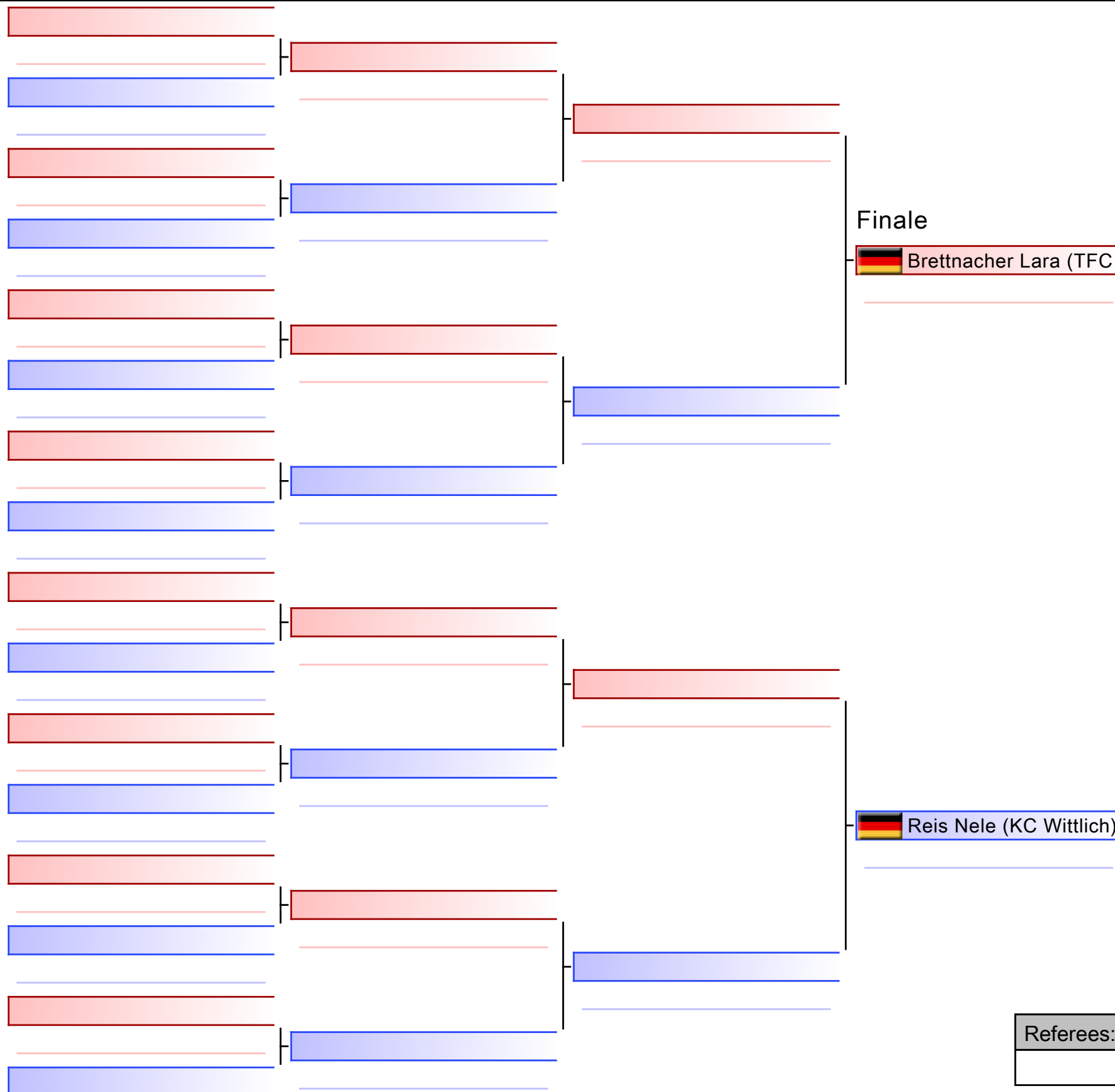

Finale

 Brettbacher Lara (TFC Westerwald)

3

 Brettbacher Lara (TFC Westerwald)

 Reis Nele (KC Wittlich)

2

|                                      |
|--------------------------------------|
| 1. BRETTNACHER LARA (TFC WESTERWALD) |
| 2. REIS NELE (KC WITTLICH)           |
|                                      |
|                                      |
|                                      |
|                                      |
|                                      |
|                                      |

|           |  |  |  |
|-----------|--|--|--|
| Referees: |  |  |  |
|           |  |  |  |



Offene Landesmeisterschaft Hessen  
und Rheinland - Pfalz 2024 - 2024-02-03

Offizielle Ergebnisliste

| Leistungsklasse Kumite -50 kg weiblich |                  |                              |   |               |
|--|------------------|------------------------------|---|---------------|
| 1                                      | BRETTNACHER LARA | TEAM FIGHTCLUB<br>WESTERWALD |  | GER - GERMANY |
| 2                                      | REIS NELE        | KARATE CLUB<br>WITTLICH      |  | GER - GERMANY |

LEISTUNGSKLASSE KUMITE -55 kg  
WEIBLICH



# Offene Landesmeisterschaft Hessen und Rheinland -..

## ENTRIES BY WEIGHT CATEGORY

Leistungsklasse Kumite -55 kg weiblich

As of 4 FEB 2024

| NOC Code | Gender | Name                | Seeding |
|----------|--------|---------------------|---------|
| GER      | F      | Hasic Minela        |         |
| GER      | F      | Hoffmann Maja       |         |
| GER      | F      | HOLCZER STELLA      |         |
| GER      | F      | Klautke Kristamarie |         |
| GER      | F      | Obst Tara Jennifer  |         |

# Leistungsklasse Kumite -55 kg weiblich

Offene Landesmeisterschaft Hessen und Rheinland - Pfalz 2024, Schulstraße 2, 69509 Mörlenbach, GER

2024-02-03

Tatami  
6 14:25

Pool  
1/1

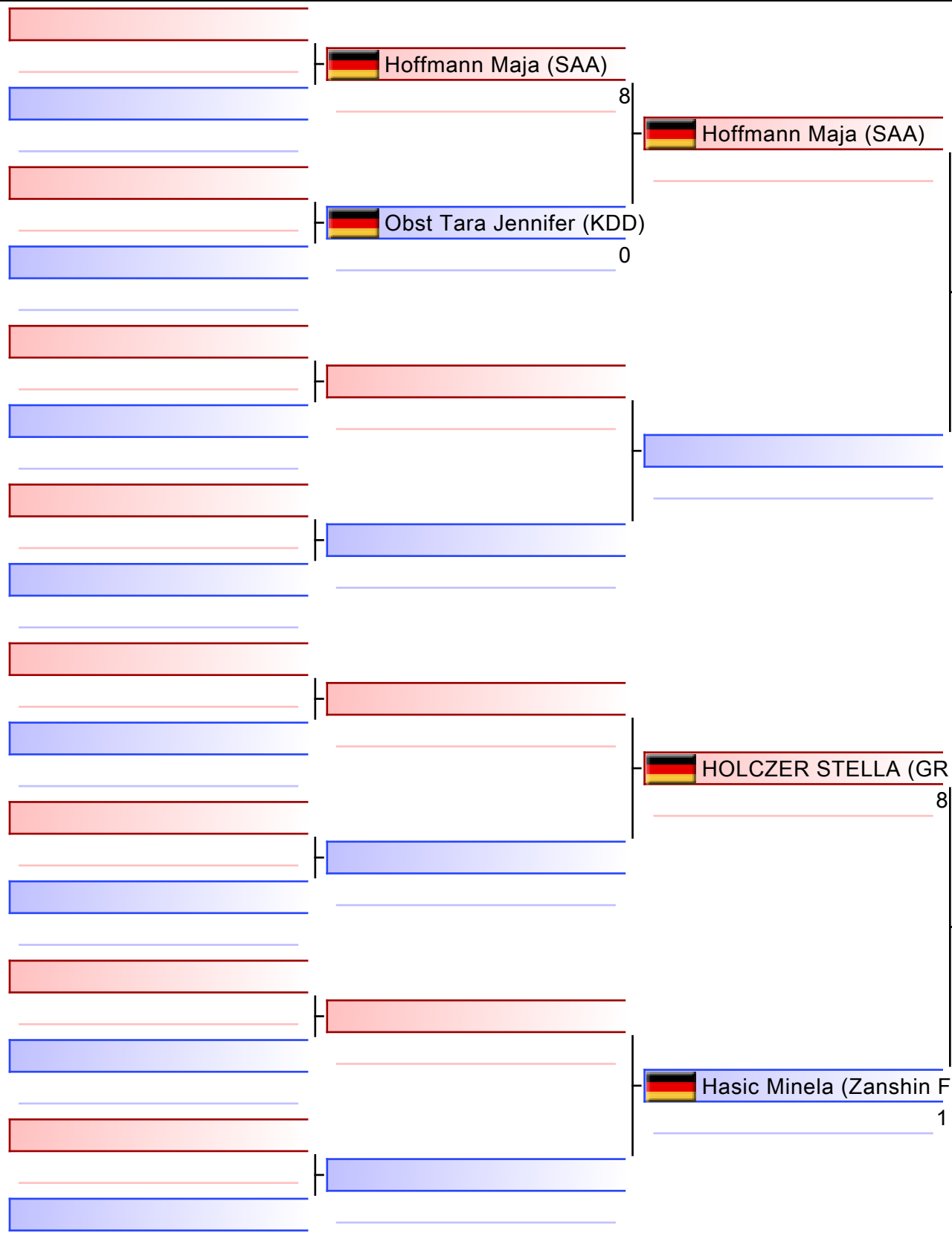

|                                      |
|--------------------------------------|
| 1. HOLLZER STELLA (GR SCHIFFERSTADT) |
| 2. HOFFMANN MAJA (SAA)               |
| 3. OBST TARA JENNIFER (KDD)          |
| 3. HASIC MINELA (ZANSHIN FULDA)      |
|                                      |
|                                      |
|                                      |

|           |  |  |  |
|-----------|--|--|--|
| Referees: |  |  |  |
|           |  |  |  |



# Leistungsklasse Kumite -55 kg weiblich

Offene Landesmeisterschaft Hessen und Rheinland - Pfalz 2024

2024-02-03

Tatami  
6 14:45

Pool  
1

(c)sportdata GmbH & Co KG 2000-2024 (2024-02-04 18:16) v 10.1.0 build 1 (2024-01-30 21:40 CET) Lizenz: Online\_Event\_ID-7816\_OffeneLandesmeisterschaftHessenundRheinlandPfalz2024 (expire 2024-02-18)

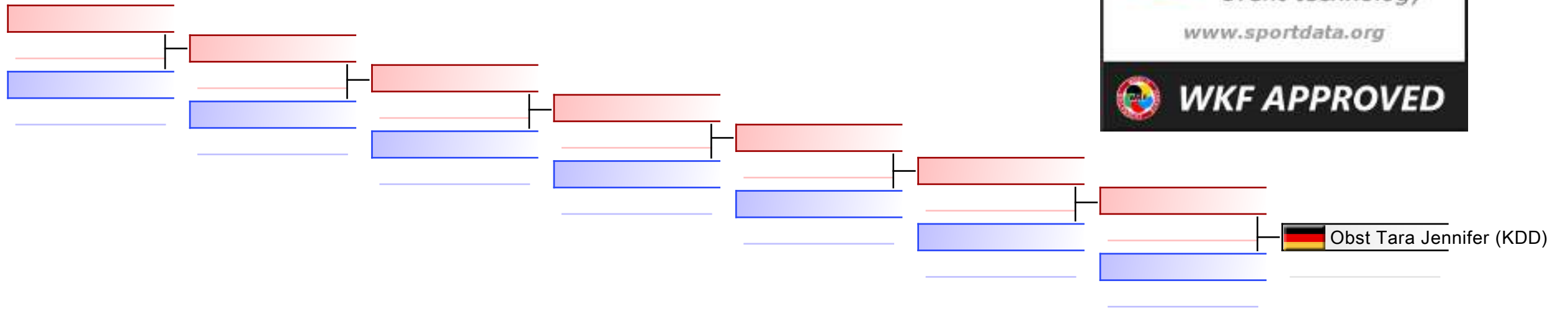

## TROSTRUNDE: (1)

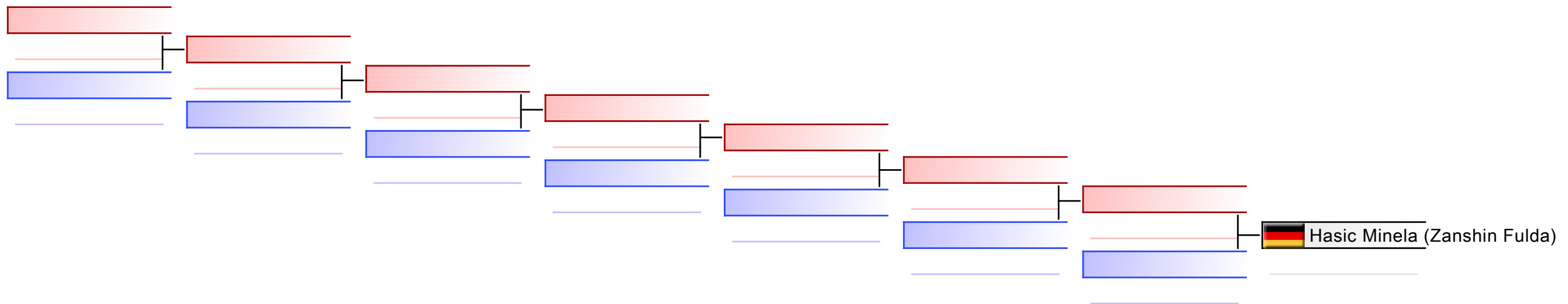

|           |  |  |  |  |  |  |  |
|-----------|--|--|--|--|--|--|--|
| Referees: |  |  |  |  |  |  |  |
|-----------|--|--|--|--|--|--|--|



Offene Landesmeisterschaft Hessen  
und Rheinland - Pfalz 2024 - 2024-02-03

Offizielle Ergebnisliste

| Leistungsklasse Kumite -55 kg weiblich |                    |  |   |               |
|--|--------------------|--|---|---------------|
| 1                                      | HOLCZER STELLA     | GOJU-RYU<br>KARATEVEREIN<br>SCHIFFERSTADT E.V. |  | GER - GERMANY |
| 2                                      | HOFFMANN MAJA      | SAARLANDISCHER<br>KARATE- VERBAND<br>E.V.      |  | GER - GERMANY |
| 3                                      | OBST TARA JENNIFER | KARATE DOJO<br>DIETZENBACH                     |  | GER - GERMANY |
| 3                                      | HASIC MINELA       | ZANSHIN GRÜN-<br>WEISS FULDA                   |  | GER - GERMANY |



LEISTUNGSKLASSE KUMITE -60 kg  
MÄNNLICH



# Offene Landesmeisterschaft Hessen und Rheinland -..

## ENTRIES BY WEIGHT CATEGORY

Leistungsklasse Kumite -60 kg männlich

As of 4 FEB 2024

| NOC Code | Gender | Name                 | Seeding |
|----------|--------|----------------------|---------|
| GER      | M      | Blumenauer Alec      |         |
| GER      | M      | Egerland Marvin-Luca |         |
| GER      | M      | Harisow Maxim        |         |

# Leistungsklasse Kumite -60 kg männlich

Offene Landesmeisterschaft Hessen und Rheinland - Pfalz 2024, Schulstraße 2, 69509 Mörlenbach, GER

2024-02-03

Tatami  
1 14:35

Pool  
1/1

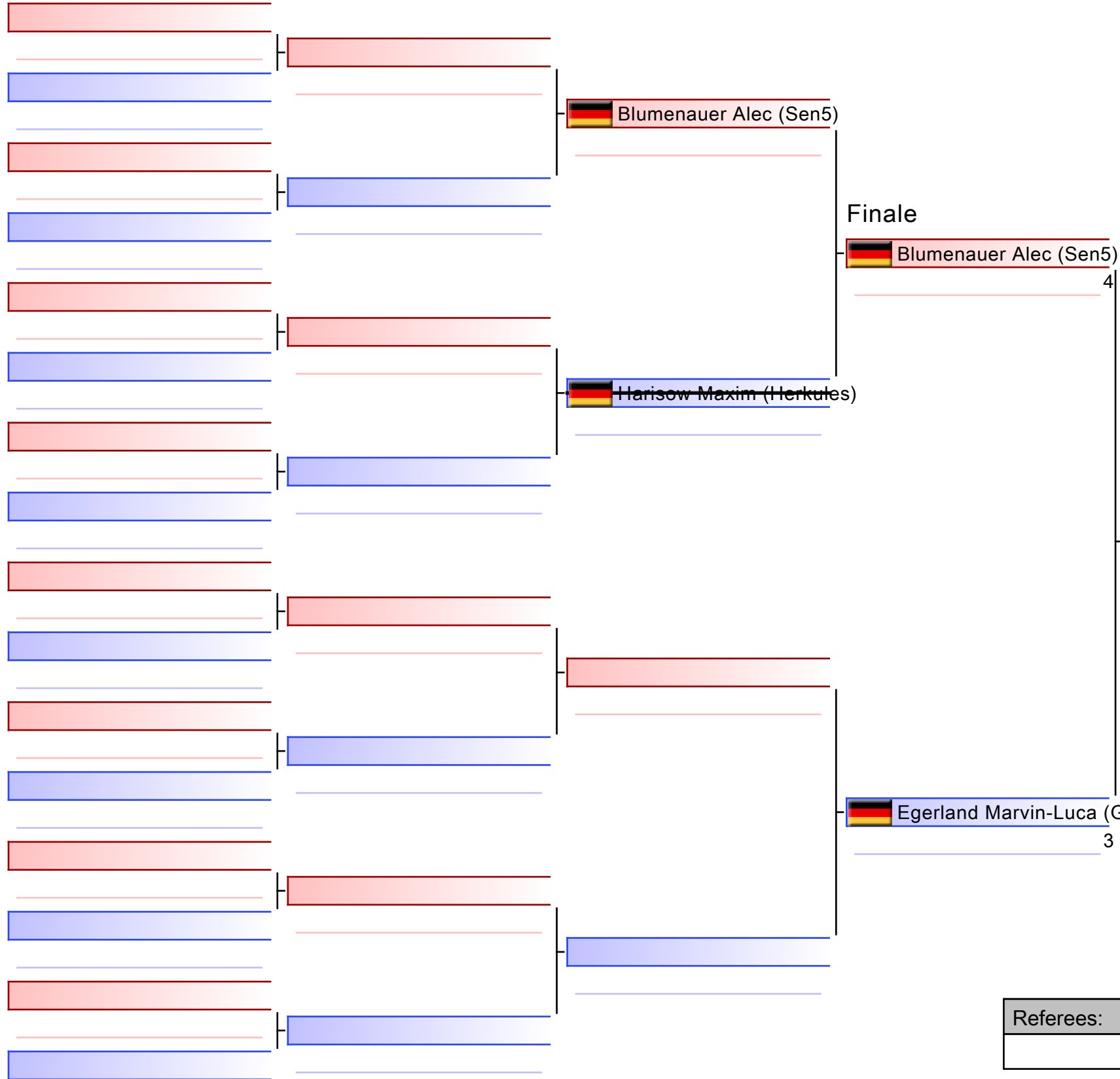

|  |
|--|
| 1. BLUMENAUER ALEC (SEN5)                  |
| 2. EGERLAND MARVIN-LUCA (GR SCHIFFERSTADT) |
|  |
|  |
|  |
|  |
|  |

|           |  |  |  |
|-----------|--|--|--|
| Referees: |  |  |  |
|           |  |  |  |



Offene Landesmeisterschaft Hessen  
und Rheinland - Pfalz 2024 - 2024-02-03

Offizielle Ergebnisliste

| Leistungsklasse Kumite -60 kg männlich |                      |  |   |               |
|--|----------------------|--|---|---------------|
| 1                                      | BLUMENAUER ALEC      | SEN5 KARATE<br>VEREIN E.V.                     |  | GER - GERMANY |
| 2                                      | EGERLAND MARVIN-LUCA | GOJU-RYU<br>KARATEVEREIN<br>SCHIFFERSTADT E.V. |  | GER - GERMANY |



LEISTUNGSKLASSE KUMITE -61 kg  
WEIBLICH



# Offene Landesmeisterschaft Hessen und Rheinland -..

## ENTRIES BY WEIGHT CATEGORY

Leistungsklasse Kumite -61 kg weiblich

As of 4 FEB 2024

| NOC Code | Gender | Name          | Seeding |
|----------|--------|---------------|---------|
| GER      | F      | Weiler Mariel |         |
| GER      | F      | Worms Lara    |         |



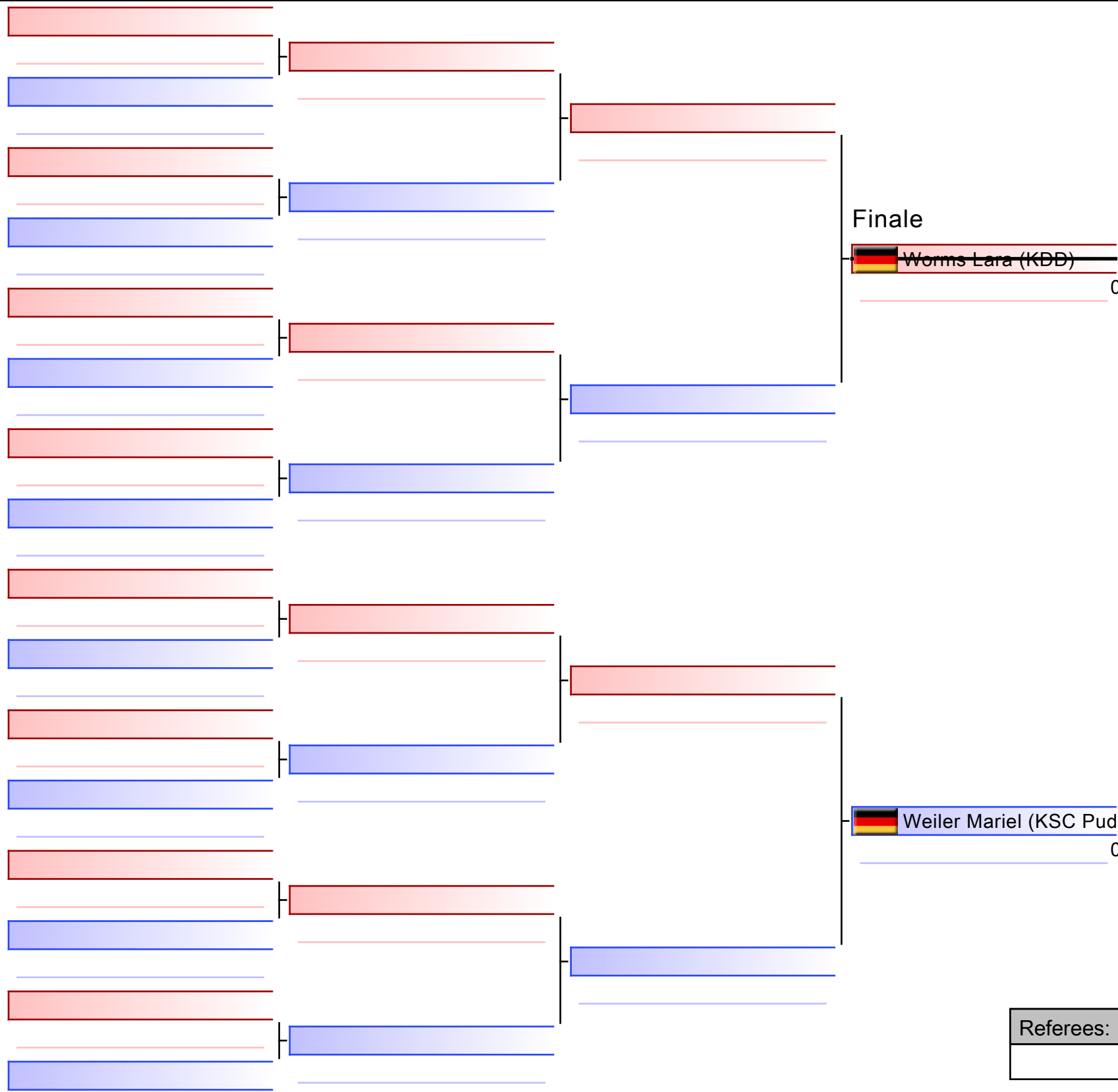

Finale

Worms Lara (KDD)

0

Weiler Mariel (KSC Puderbach)

Weiler Mariel (KSC Puderbach)

0

|                                  |
|----------------------------------|
| 1. WEILER MARIEL (KSC PUDERBACH) |
|                                  |
|                                  |
|                                  |
|                                  |
|                                  |
|                                  |

|           |  |  |  |
|-----------|--|--|--|
| Referees: |  |  |  |
|           |  |  |  |



Offene Landesmeisterschaft Hessen  
und Rheinland - Pfalz 2024 - 2024-02-03

Offizielle Ergebnisliste

| Leistungsklasse Kumite -61 kg weiblich |               |                              |   |               |
|--|---------------|------------------------------|---|---------------|
| 1                                      | WEILER MARIEL | KARATE TEAM KSC<br>PUDERBACH |  | GER - GERMANY |



LEISTUNGSKLASSE KUMITE -67 kg  
MÄNNLICH



# Offene Landesmeisterschaft Hessen und Rheinland -..

## ENTRIES BY WEIGHT CATEGORY

Leistungsklasse Kumite -67 kg männlich

As of 4 FEB 2024

| NOC Code | Gender | Name                                 | Seeding |
|----------|--------|--------------------------------------|---------|
| GER      | M      | Alkatep Ahmad                        |         |
| GER      | M      | Azimi Massihulla                     |         |
| GER      | M      | Chuutchen-Chuigone Emeran De S-Roger |         |
| GER      | M      | Helm Marius                          |         |
| GER      | M      | Quadt Lukas                          |         |
| GER      | M      | Takzima Aymane                       |         |
| GER      | M      | Thran Melvin                         |         |

# Leistungsklasse Kumite -67 kg männlich

Offene Landesmeisterschaft Hessen und Rheinland - Pfalz 2024, Schulstraße 2, 69509 Mörlenbach, GER

2024-02-03

Tatami  
3 14:15

Pool  
1/1

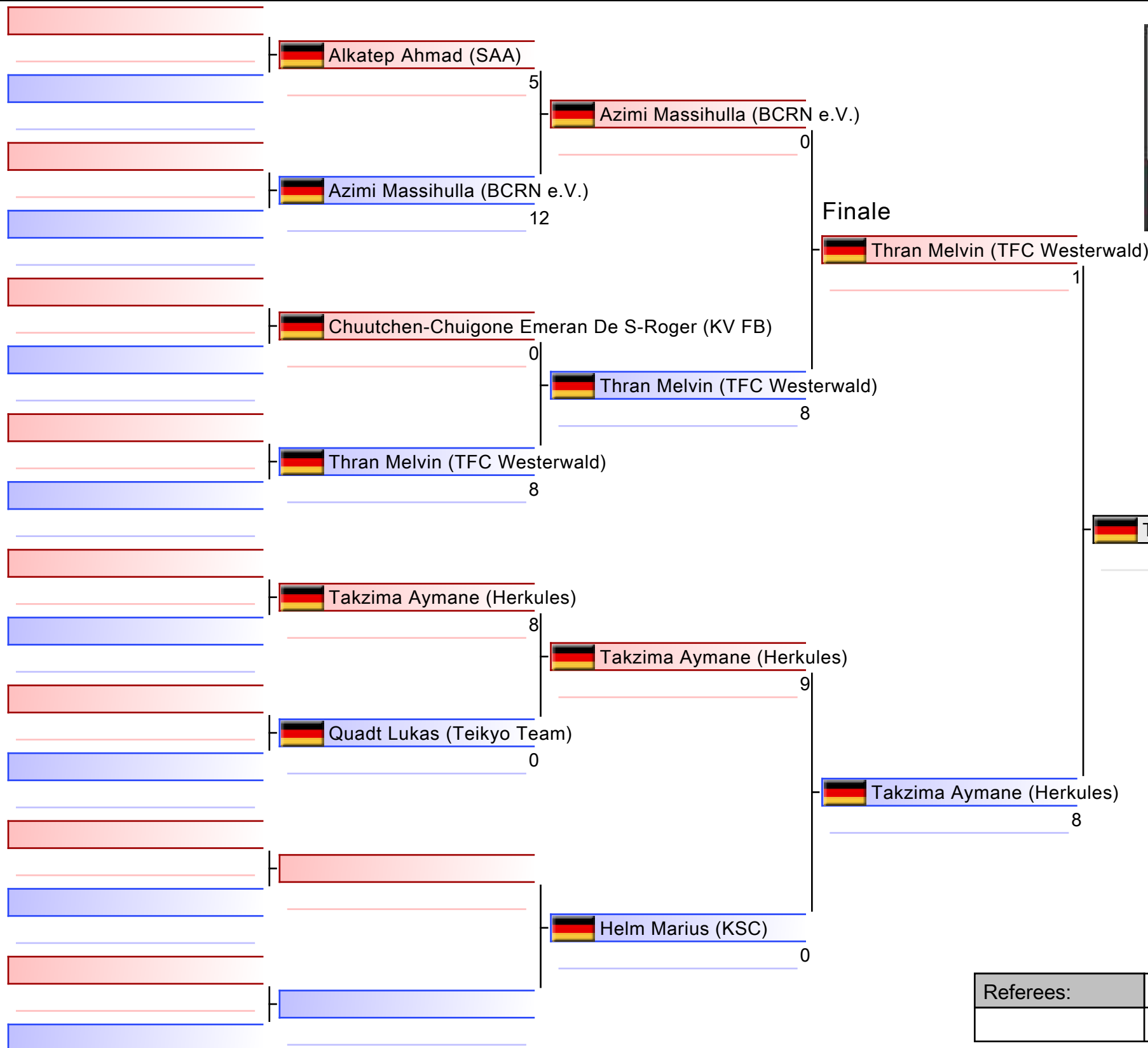

|   |
|---|
| 1. TAKZIMA AYMANE (HERKULES)            |
| 2. THRAN MELVIN (TFC WESTERWALD)        |
| 3. AZIMI MASSIHULLA (BCRN E.V.)         |
| 3. QUADT LUKAS (TEIKYO TEAM)            |
| 5. CHUUTCHEN-CHUIGONE EMERAN DE S-ROGER |
| 5. HELM MARIUS (KSC)                    |
|   |
|   |

|           |  |  |  |
|-----------|--|--|--|
| Referees: |  |  |  |
|           |  |  |  |





Offene Landesmeisterschaft Hessen  
und Rheinland - Pfalz 2024 - 2024-02-03

Offizielle Ergebnisliste

| Leistungsklasse Kumite -67 kg männlich |   |                                |   |               |  |
|--|---|--------------------------------|---|---------------|--|
| 1                                      | TAKZIMA AYMANE                          | SV HERKULES 01<br>KASSEL E.V.  |  | GER - GERMANY |  |
| 2                                      | THRAN MELVIN                            | TEAM FIGHTCLUB<br>WESTERWALD   |  | GER - GERMANY |  |
| 3                                      | AZIMI MASSIHULLA                        | BUDOCLUB RHEIN-<br>NECKAR E.V. |  | GER - GERMANY |  |
| 3                                      | QUADT LUKAS                             | TEIKYO KARATE<br>TEAM E.V.     |  | GER - GERMANY |  |
| 5                                      | CHUUTCHEN-CHUIGONE<br>EMERAN DE S-ROGER | KARATEVEREIN<br>FRIEDBERG      |  | GER - GERMANY |  |
| 5                                      | HELM MARIUS                             | KAMPFSPORT CLUB<br>HÜNFELD     |  | GER - GERMANY |  |

LEISTUNGSKLASSE KUMITE -68 kg  
WEIBLICH





# Offene Landesmeisterschaft Hessen und Rheinland -..

## ENTRIES BY WEIGHT CATEGORY

Leistungsklasse Kumite -68 kg weiblich

As of 4 FEB 2024

| NOC Code | Gender | Name                      | Seeding |
|----------|--------|---------------------------|---------|
| GER      | F      | Djapa Sara                |         |
| GER      | F      | Eizadyariaghmiyouni Paria |         |
| GER      | F      | Langer Leticia            |         |
| GER      | F      | Wolz Anna                 |         |

# Leistungsklasse Kumite -68 kg weiblich

Offene Landesmeisterschaft Hessen und Rheinland - Pfalz 2024, Schulstraße 2, 69509 Mörlenbach, GER

2024-02-03

Tatami

2 14:25

Pool

1/1

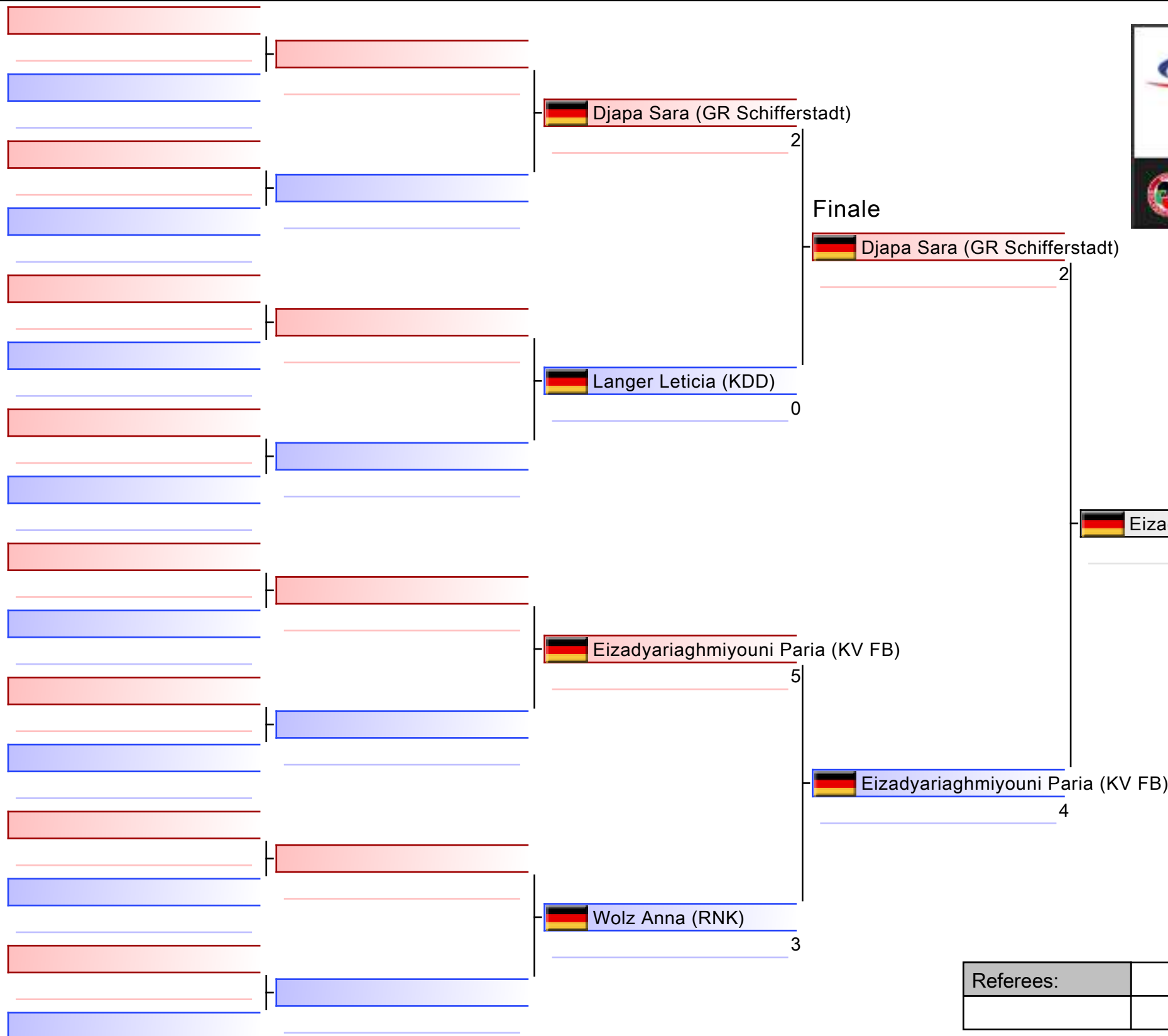

|                                      |
|--------------------------------------|
| 1. EIZADYARIAGHMIYOUNI PARIA (KV FB) |
| 2. DJAPA SARA (GR SCHIFFERSTADT)     |
| 3. LANGER LETICIA (KDD)              |
| 3. WOLZ ANNA (RNK)                   |
|                                      |
|                                      |
|                                      |

|           |  |  |  |
|-----------|--|--|--|
| Referees: |  |  |  |
|           |  |  |  |

# Leistungsklasse Kumite -68 kg weiblich

Offene Landesmeisterschaft Hessen und Rheinland - Pfalz 2024

Tatami

Pool

1

(c)sportdata GmbH & Co KG 2000-2024 (2024-02-04 18:16) v 10.1.0 build 1 (2024-01-30 21:40 CET) Lizenz: Online\_Event\_ID-7816\_OffeneLandesmeisterschaftHessenundRheinlandPfalz2024 (expire 2024-02-18)

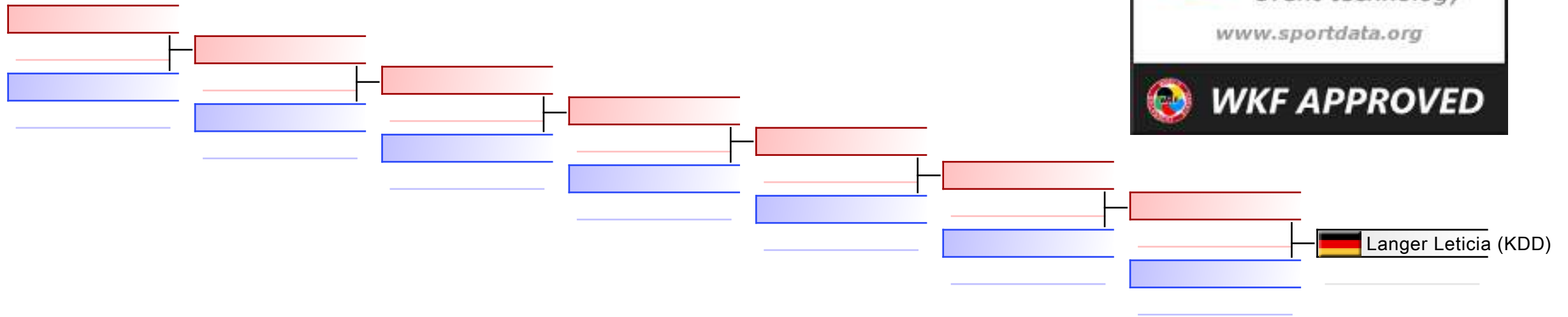

## TROSTRUNDE: (1)

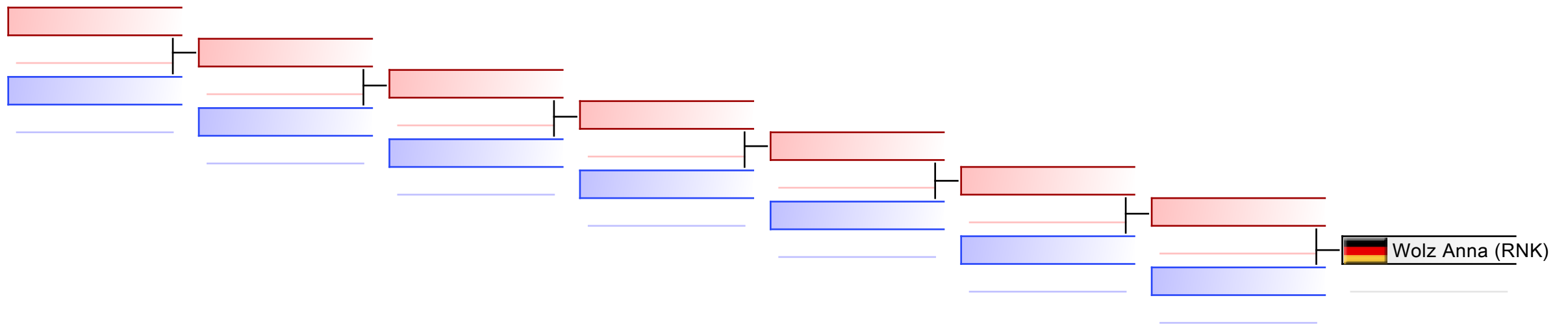

|           |  |  |  |  |  |  |  |
|-----------|--|--|--|--|--|--|--|
| Referees: |  |  |  |  |  |  |  |
|-----------|--|--|--|--|--|--|--|



Offene Landesmeisterschaft Hessen  
und Rheinland - Pfalz 2024 - 2024-02-03

Offizielle Ergebnisliste

| Leistungsklasse Kumite -68 kg weiblich |                           |  |   |               |
|--|---------------------------|--|---|---------------|
| 1                                      | EIZADYARIAGHMIYOUNI PARIA | KARATEVEREIN<br>FRIEDBERG                      |  | GER - GERMANY |
| 2                                      | DJAPA SARA                | GOJU-RYU<br>KARATEVEREIN<br>SCHIFFERSTADT E.V. |  | GER - GERMANY |
| 3                                      | LANGER LETICIA            | KARATE DOJO<br>DIETZENBACH                     |  | GER - GERMANY |
| 3                                      | WOLZ ANNA                 | RHEIN-NECKAR<br>KNIGHTS                        |  | GER - GERMANY |



LEISTUNGSKLASSE KUMITE -75 kg  
MÄNNLICH



# Offene Landesmeisterschaft Hessen und Rheinland -..

## ENTRIES BY WEIGHT CATEGORY

Leistungsklasse Kumite -75 kg männlich

As of 4 FEB 2024

| NOC Code | Gender | Name                | Seeding |
|----------|--------|---------------------|---------|
| GER      | M      | Aslan Emre          |         |
| GER      | M      | Beyersdörfer Philip |         |
| GER      | M      | Bier Marvin         |         |
| GER      | M      | Mawardi Ahmad       |         |
| GER      | M      | Schmauder Julius    |         |
| GER      | M      | Schoppel Martin     |         |

# Leistungsklasse Kumite -75 kg männlich

Offene Landesmeisterschaft Hessen und Rheinland - Pfalz 2024, Schulstraße 2, 69509 Mörlenbach, GER

2024-02-03

Tatami  
4 14:15

Pool  
1/1

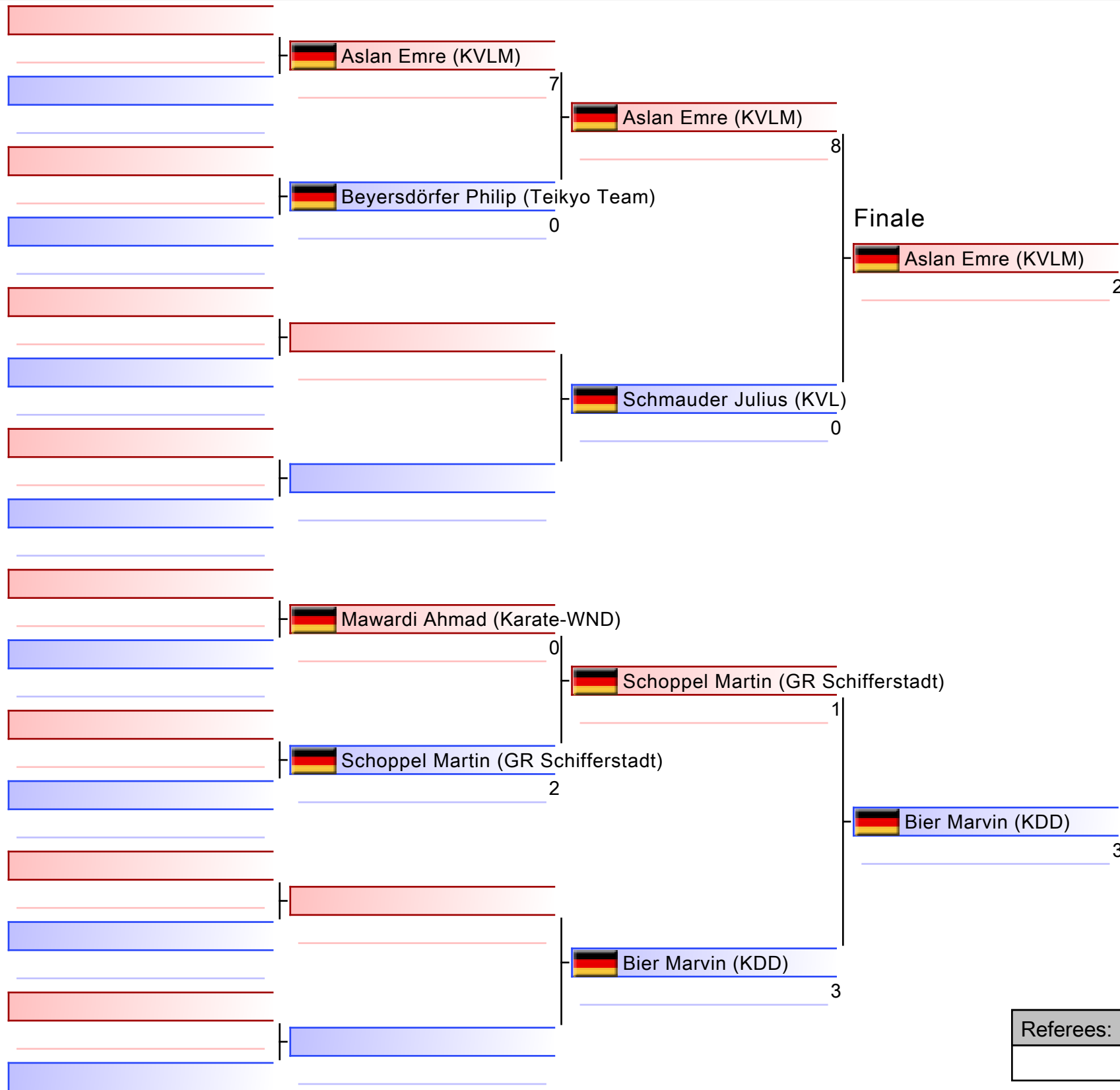

|                                       |
|---------------------------------------|
| 1. BIER MARVIN (KDD)                  |
| 2. ASLAN EMRE (KVLM)                  |
| 3. SCHOPPEL MARTIN (GR SCHIFFERSTADT) |
| 3. BEYERSDÖRFER PHILIP (TEIKYO TEAM)  |
| 5. SCHMAUDER JULIUS (KVL)             |
|                                       |
|                                       |

|           |  |  |  |
|-----------|--|--|--|
| Referees: |  |  |  |
|           |  |  |  |

Leistungsklasse Kumite -75 kg männlich

Offene Landesmeisterschaft Hessen und Rheinland - Pfalz 2024

2024-02-03

Tatami

4 14:40

Pool

1

(c)sportdata GmbH & Co KG 2000-2024 (2024-02-04 18:16) v 10.1.0 build 1 (2024-01-30 21:40 CET) Lizenz: Online\_Event\_ID-7816\_OffeneLandesmeisterschaftHessenundRheinlandPfalz2024 (expire 2024-02-18)

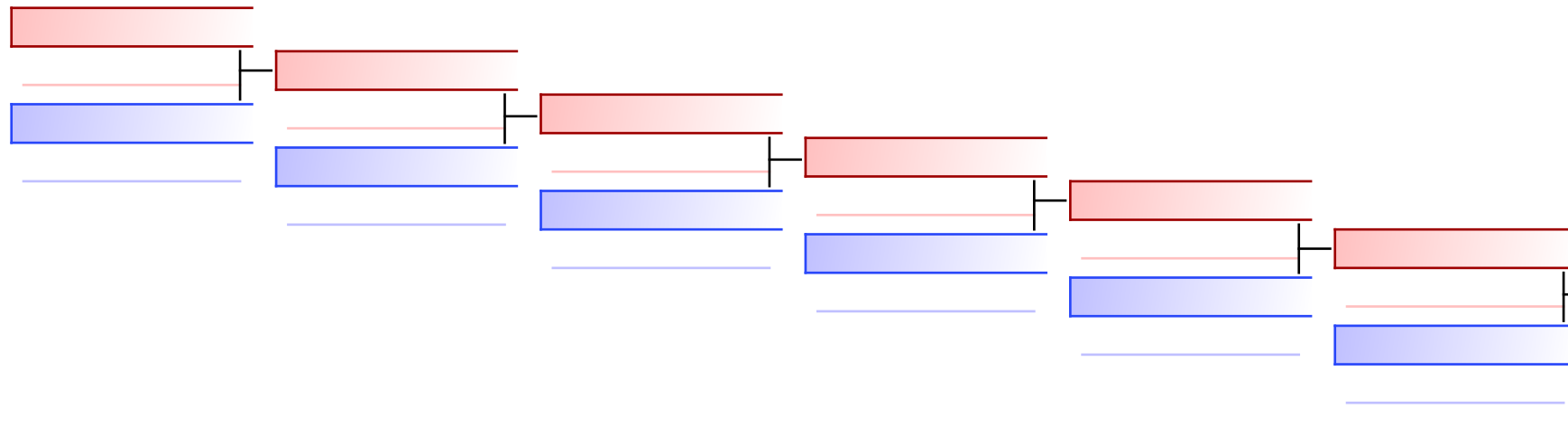

Beyersdörfer Philip (Teikyo Team)  
8  
 Beyersdörfer Philip (Teikyo Team)  
 Schmauder Julius (KVL)  
0

TROSTRUNDE: (1)

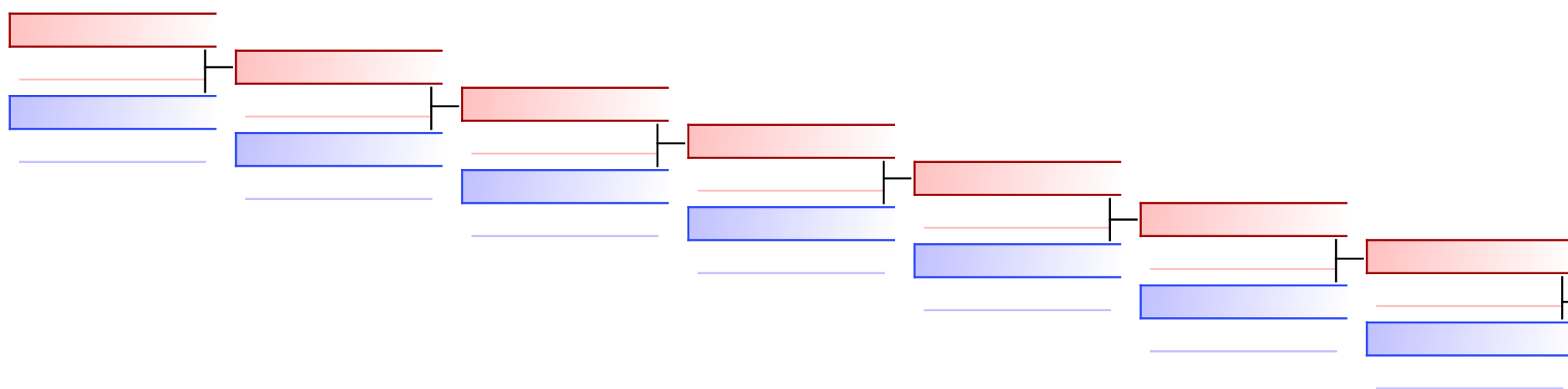

Schoppel Martin (GR Schiffersta...

|           |  |  |  |  |  |  |  |
|-----------|--|--|--|--|--|--|--|
| Referees: |  |  |  |  |  |  |  |
|-----------|--|--|--|--|--|--|--|





Offene Landesmeisterschaft Hessen  
und Rheinland - Pfalz 2024 - 2024-02-03

Offizielle Ergebnisliste

| Leistungsklasse Kumite -75 kg männlich |                     |  |   |               |
|--|---------------------|--|---|---------------|
| 1                                      | BIER MARVIN         | KARATE DOJO<br>DIETZENBACH                     |  | GER - GERMANY |
| 2                                      | ASLAN EMRE          | KV LIMBURG                                     |  | GER - GERMANY |
| 3                                      | SCHOPPEL MARTIN     | GOJU-RYU<br>KARATEVEREIN<br>SCHIFFERSTADT E.V. |  | GER - GERMANY |
| 3                                      | BEYERSDÖRFER PHILIP | TEIKYO KARATE<br>TEAM E.V.                     |  | GER - GERMANY |
| 5                                      | SCHMAUDER JULIUS    | KARATE-VEREIN<br>LANGEN E.V.                   |  | GER - GERMANY |

LEISTUNGSKLASSE KUMITE -84 kg  
MÄNNLICH



# Offene Landesmeisterschaft Hessen und Rheinland -..

## ENTRIES BY WEIGHT CATEGORY

Leistungsklasse Kumite -84 kg männlich

As of 4 FEB 2024

| NOC Code | Gender | Name               | Seeding |
|----------|--------|--------------------|---------|
| GER      | M      | Eul Jan            |         |
| GER      | M      | Hoffmann Jan       |         |
| GER      | M      | Le Minh-Thuong     |         |
| GER      | M      | Scharf Wlad        |         |
| GER      | M      | Schäfer Timo Maria |         |
| GER      | M      | Ullrich Thomas     |         |

# Leistungsklasse Kumite -84 kg männlich

Offene Landesmeisterschaft Hessen und Rheinland - Pfalz 2024, Schulstraße 2, 69509 Mörlenbach, GER

2024-02-03

Tatami  
6 13:45

Pool  
1/1

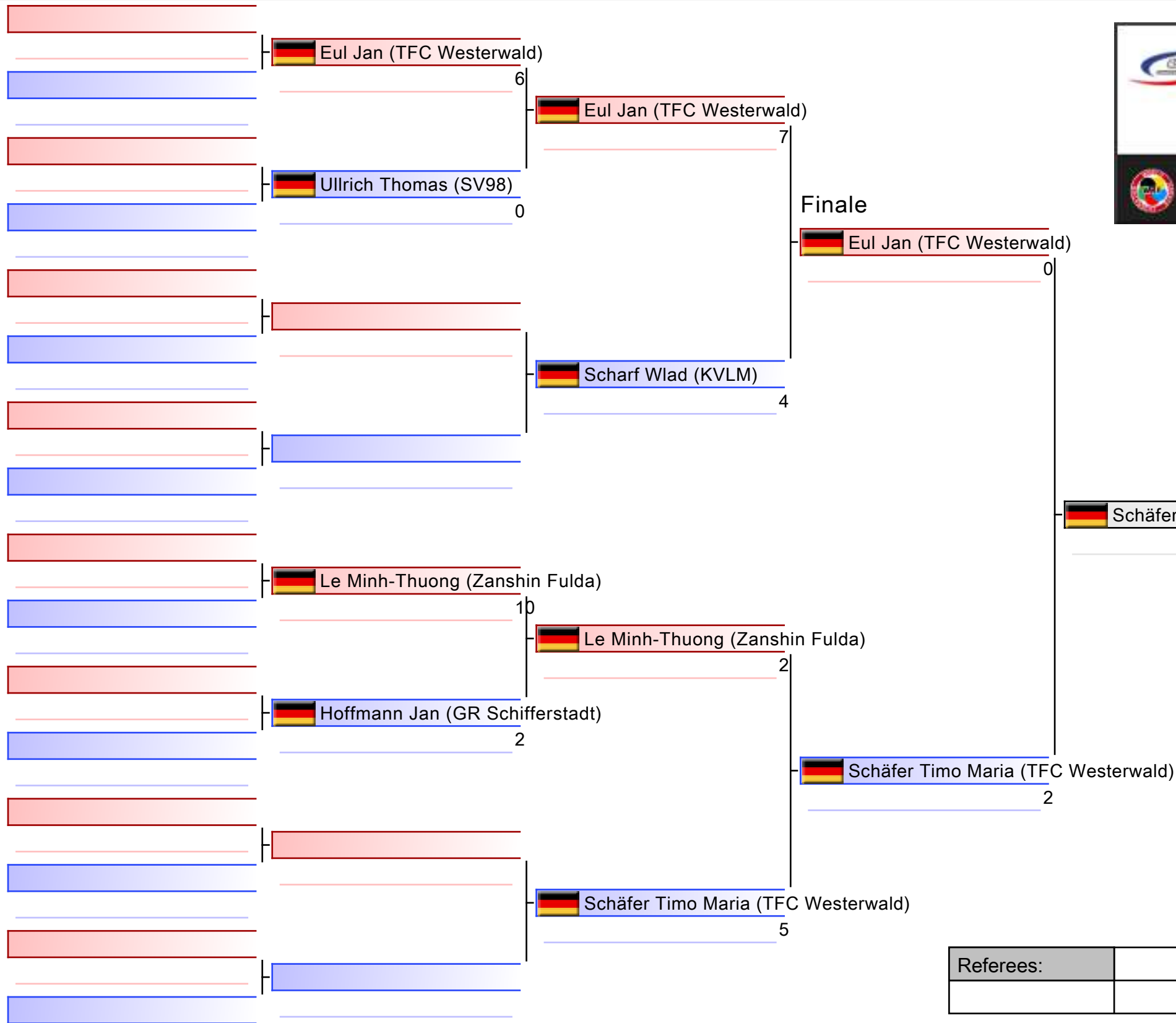

|  |
|--|
| 1. SCHÄFER TIMO MARIA (TFC WESTERWALD) |
| 2. EUL JAN (TFC WESTERWALD)            |
| 3. LE MINH-THUONG (ZANSHIN FULDA)      |
| 3. SCHARF WLAD (KVLM)                  |
| 5. ULLRICH THOMAS (SV98)               |
|  |
|  |

|           |  |  |  |
|-----------|--|--|--|
| Referees: |  |  |  |
|           |  |  |  |

Leistungsklasse Kumite -84 kg männlich

Offene Landesmeisterschaft Hessen und Rheinland - Pfalz 2024

2024-02-03

Tatami  
6 14:10

Pool  
1

(c)sportdata GmbH & Co KG 2000-2024 (2024-02-04 18:16) v 10.1.0 build 1 (2024-01-30 21:40 CET) Lizenz: Online\_Event\_ID-7816\_OffeneLandesmeisterschaftHessenundRheinlandPfalz2024 (expire 2024-02-18)

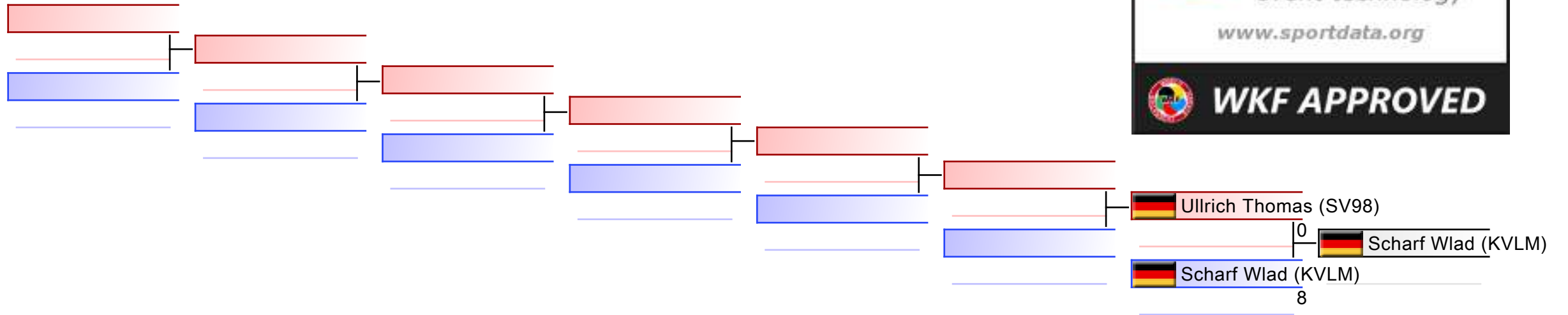

TROSTRUNDE: (1)

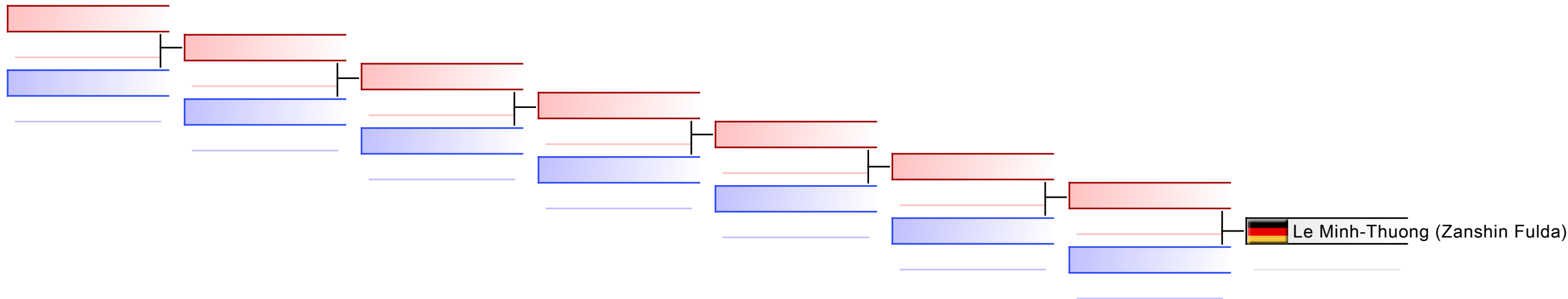

|           |  |  |  |  |  |  |  |
|-----------|--|--|--|--|--|--|--|
| Referees: |  |  |  |  |  |  |  |
|-----------|--|--|--|--|--|--|--|



Offene Landesmeisterschaft Hessen  
und Rheinland - Pfalz 2024 - 2024-02-03

Offizielle Ergebnisliste

| Leistungsklasse Kumite -84 kg männlich |                    |                              |   |               |
|--|--------------------|------------------------------|---|---------------|
| 1                                      | SCHÄFER TIMO MARIA | TEAM FIGHTCLUB<br>WESTERWALD |  | GER - GERMANY |
| 2                                      | EUL JAN            | TEAM FIGHTCLUB<br>WESTERWALD |  | GER - GERMANY |
| 3                                      | LE MINH-THUONG     | ZANSHIN GRÜN-<br>WEISS FULDA |  | GER - GERMANY |
| 3                                      | SCHARF WLAD        | KV LIMBURG                   |  | GER - GERMANY |
| 5                                      | ULLRICH THOMAS     | SV DARMSTADT 98              |  | GER - GERMANY |

LEISTUNGSKLASSE KUMITE TEAM  
WEIBLICH



# Offene Landesmeisterschaft Hessen und Rheinland -..

## ENTRIES BY WEIGHT CATEGORY

### Leistungsklasse Kumite Team weiblich

As of 4 FEB 2024

| NOC Code | Gender | Name                | Seeding |
|----------|--------|---------------------|---------|
| GER      | F      | Brettnacher Lara    |         |
| GER      | F      | Djapa Sara          |         |
| GER      | F      | HOLCZER STELLA      |         |
| GER      | F      | Klautke Kristamarie |         |
| GER      | F      | Langer Leticia      |         |
| GER      | F      | Mielke Nele         |         |
| GER      | F      | Mujezinovic Samira  |         |
| GER      | F      | Obst Tara Jennifer  |         |
| GER      | F      | Weiler Mariel       |         |
| GER      | F      | Wolz Anna           |         |
| GER      | F      | Worms Lara          |         |



# Leistungsklasse Kumite Team weiblich

Offene Landesmeisterschaft Hessen und Rheinland - Pfalz 2024, Schulstraße 2, 69509 Mörlenbach, GER

2024-02-03

Tatami

1 15:25

Pool

1/1

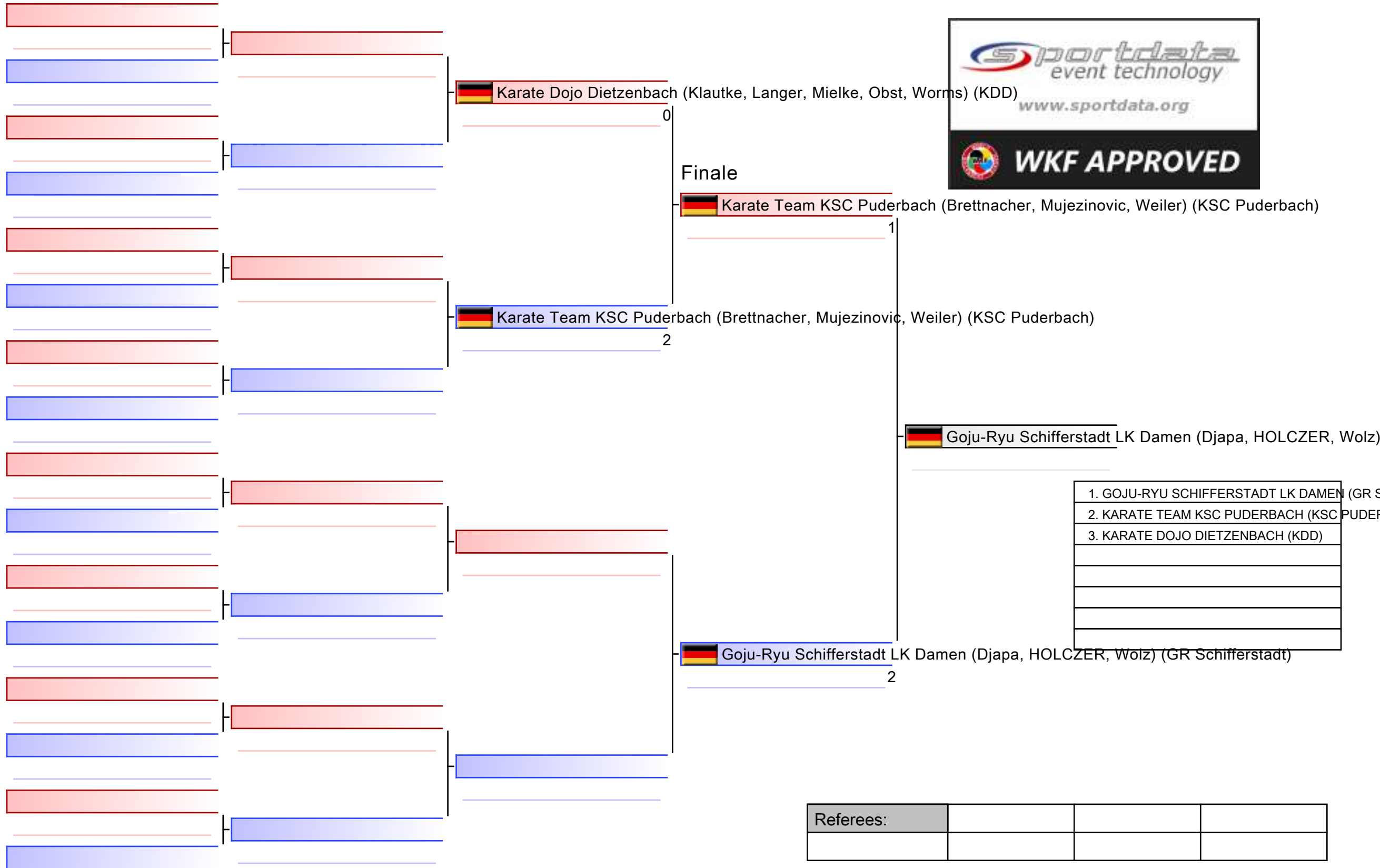

# Leistungsklasse Kumite Team weiblich

Offene Landesmeisterschaft Hessen und Rheinland - Pfalz 2024

Tatami

Pool

1

(c)sportdata GmbH & Co KG 2000-2024 (2024-02-04 18:16) v 10.1.0 build 1 (2024-01-30 21:40 CET) Lizenz: Online\_Event\_ID-7816\_OffeneLandesmeisterschaftHessenundRheinlandPfalz2024 (expire 2024-02-18)

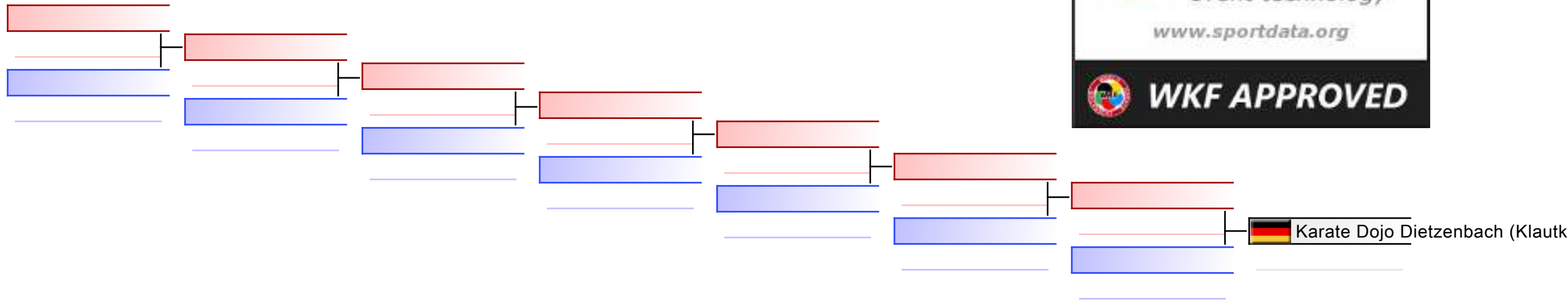

## TROSTRUNDE: (1)

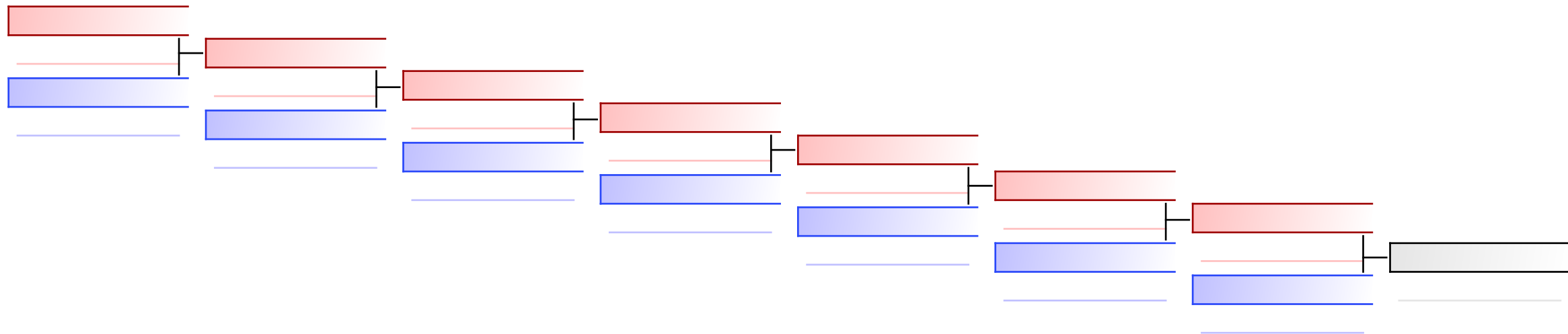

|           |  |  |  |  |  |  |  |
|-----------|--|--|--|--|--|--|--|
| Referees: |  |  |  |  |  |  |  |
|-----------|--|--|--|--|--|--|--|



Offene Landesmeisterschaft Hessen  
und Rheinland - Pfalz 2024 - 2024-02-03

Offizielle Ergebnisliste

| Leistungsklasse Kumite Team weiblich |   |  |   |               |
|--------------------------------------|---|--|---|---------------|
| 1                                    | GOJU-RYU SCHIFFERSTADT LK DAMEN<br>- HOLCZER STELLA<br>- WOLZ ANNA<br>- DJAPA SARA  | GOJU-RYU<br>KARATEVEREIN<br>SCHIFFERSTADT E.V. |  | GER - GERMANY |
| 2                                    | KARATE TEAM KSC PUDERBACH<br>- WEILER MARIEL<br>- MUJEZINOVIC SAMIRA<br>- BRETTNACHER LARA                                    | KARATE TEAM KSC<br>PUDERBACH                   |  | GER - GERMANY |
| 3                                    | KARATE DOJO DIETZENBACH<br>- KLAUTKE KRISTAMARIE<br>- LANGER LETICIA<br>- MIELKE NELE<br>- OBST TARA_JENNIFER<br>- WORMS LARA | KARATE DOJO<br>DIETZENBACH                     |  | GER - GERMANY |



# MASTERKLASSE KATA TEAM MIX



# Offene Landesmeisterschaft Hessen und Rheinland -..

## ENTRIES BY WEIGHT CATEGORY

### Masterklasse Kata Team mixed

As of 4 FEB 2024

| NOC Code | Gender | Name              | Seeding |
|----------|--------|-------------------|---------|
| GER      | M      | Kienle Jürgen     |         |
| GER      | F      | Leuckel Melanie   |         |
| GER      | F      | Mack Katharina    |         |
| GER      | F      | Nowicki Iris      |         |
| GER      | M      | Ochs Wilfried     |         |
| GER      | M      | Sack Klaus-Dieter |         |

# Masterklasse Kata Team mixed

Offene Landesmeisterschaft Hessen und Rheinland - Pfalz 2024, Schulstraße 2, 69509 Mörlenbach, GER

Tatami

Pool

1/1

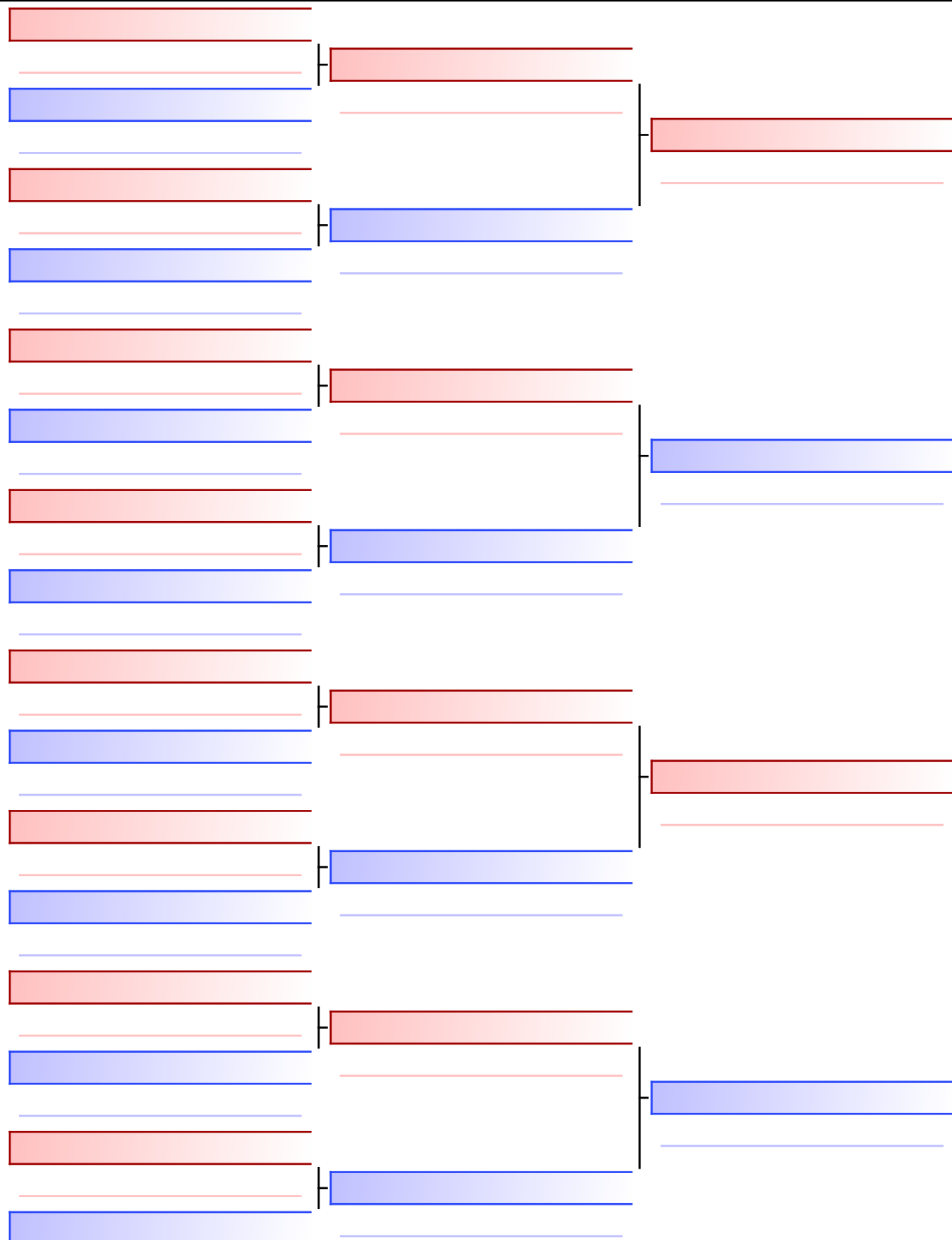

## Finale

**Katateam PSV Mainz (Kienle, Ochs, Sack) (PSV Mainz)**  
 060 Nijushiho 3720

**Katateam PSV Mainz (Kienle, Ochs, Sack) (PSV Mainz)**

**PSV Mainz Katateam (Leuckel, Mack, Nowicki) (PSV Mainz)**  
 012 Enpi 3490

|                                   |
|-----------------------------------|
| 1. KATATEAM PSV MAINZ (PSV MAINZ) |
| 2. PSV MAINZ KATATEAM (PSV MAINZ) |
|                                   |
|                                   |
|                                   |
|                                   |
|                                   |
|                                   |

|           |  |  |  |
|-----------|--|--|--|
| Referees: |  |  |  |
|           |  |  |  |



Offene Landesmeisterschaft Hessen  
und Rheinland - Pfalz 2024 - 2024-02-03

Offizielle Ergebnisliste

| Masterklasse Kata Team mixed |   |                                      |   |               |
|------------------------------|---|--------------------------------------|---|---------------|
| 1                            | KATATEAM PSV MAINZ<br>- SACK KLAUS-DIETER<br>- OCHS WILFRIED<br>- KIENLE JÜRGEN | POLIZEI<br>SPORTVEREIN<br>MAINZ E.V. |  | GER - GERMANY |
| 2                            | PSV MAINZ KATATEAM<br>- LEUCKEL MELANIE<br>- NOWICKI IRIS<br>- MACK KATHARINA   | POLIZEI<br>SPORTVEREIN<br>MAINZ E.V. |  | GER - GERMANY |

# U21 KATA DAMEN





# Offene Landesmeisterschaft Hessen und Rheinland -..

## ENTRIES BY WEIGHT CATEGORY

### U21 Kata Damen

As of 4 FEB 2024

| NOC Code | Gender | Name                  | Seeding |
|----------|--------|-----------------------|---------|
| GER      | F      | Bosserdt Vanessa      |         |
| GER      | F      | Dannenberg Christina  |         |
| GER      | F      | Dielmann Jessica      |         |
| GER      | F      | Faul Annika           |         |
| GER      | F      | Griessel Carolina     |         |
| GER      | F      | Hebbel Patricia       |         |
| GER      | F      | Krawczyk Julia        |         |
| GER      | F      | Kölsch Sarah          |         |
| GER      | F      | Nguyen Carina Ngoc Vy |         |
| GER      | F      | Sternberger Alena     |         |

# U21 Kata Damen

Offene Landesmeisterschaft Hessen und Rheinland - Pfalz 2024, Schulstraße 2, 69509 Mörlenbach, GER

2024-02-03

Tatami

4 11:05

Pool

1/2

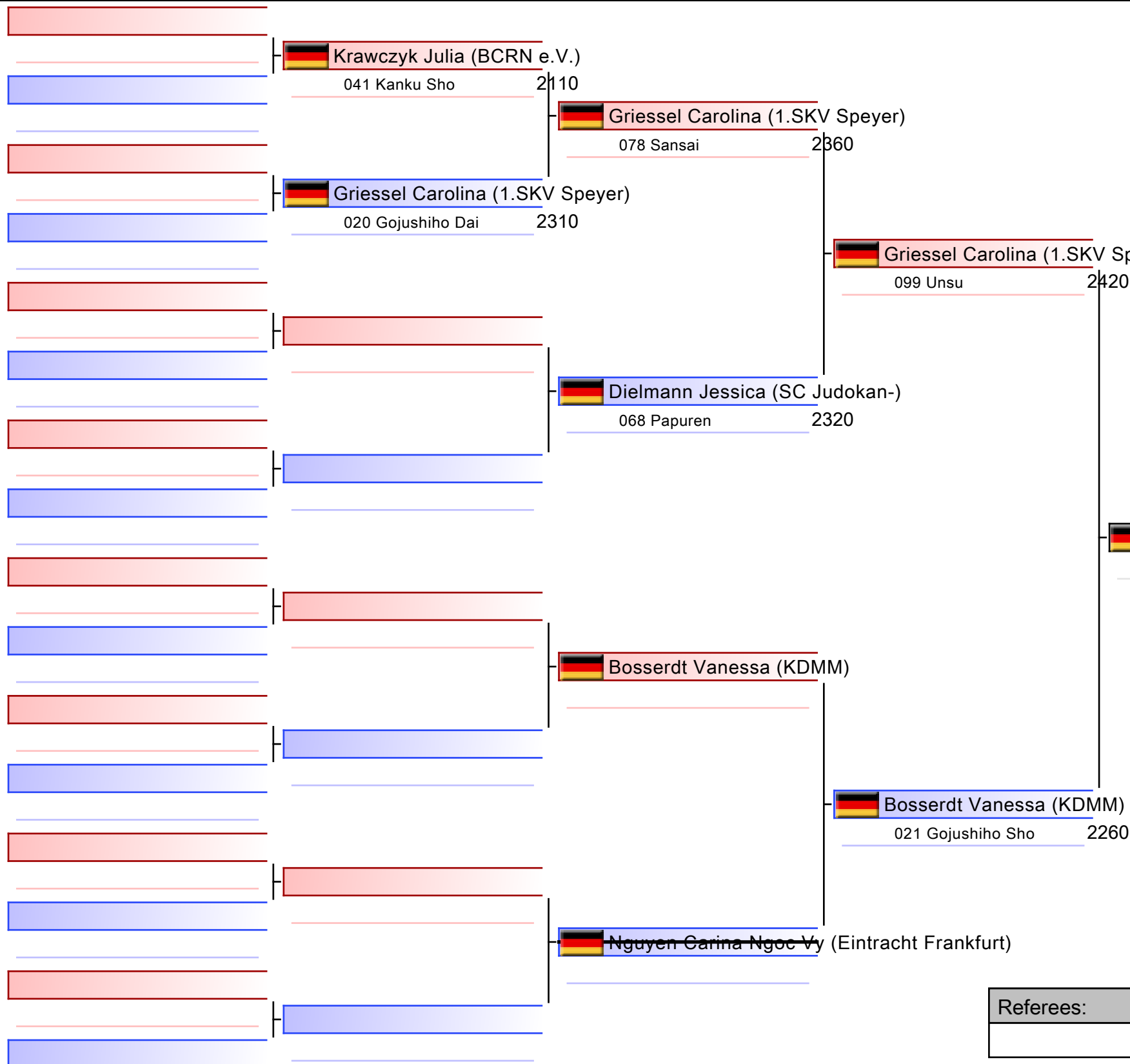

|                                    |
|------------------------------------|
| 1. HEBBEL PATRICIA (SC JUDOKAN-)   |
| 2. GRIESEL CAROLINA (1.SKV SPEYER) |
| 3. FAUL ANNIKA (IGS BUDOKAN KL)    |
| 3. DIELMANN JESSICA (SC JUDOKAN-)  |
| 5. BOSSERDT VANESSA (KDMM)         |
| 7. KRAWCZYK JULIA (BCRN E.V.)      |
|                                    |
|                                    |

|           |  |  |  |
|-----------|--|--|--|
| Referees: |  |  |  |
|           |  |  |  |

# U21 Kata Damen

Offene Landesmeisterschaft Hessen und Rheinland - Pfalz 2024, Schulstraße 2, 69509 Mörlenbach, GER

2024-02-03

Tatami

5 11:05

Pool

2/2

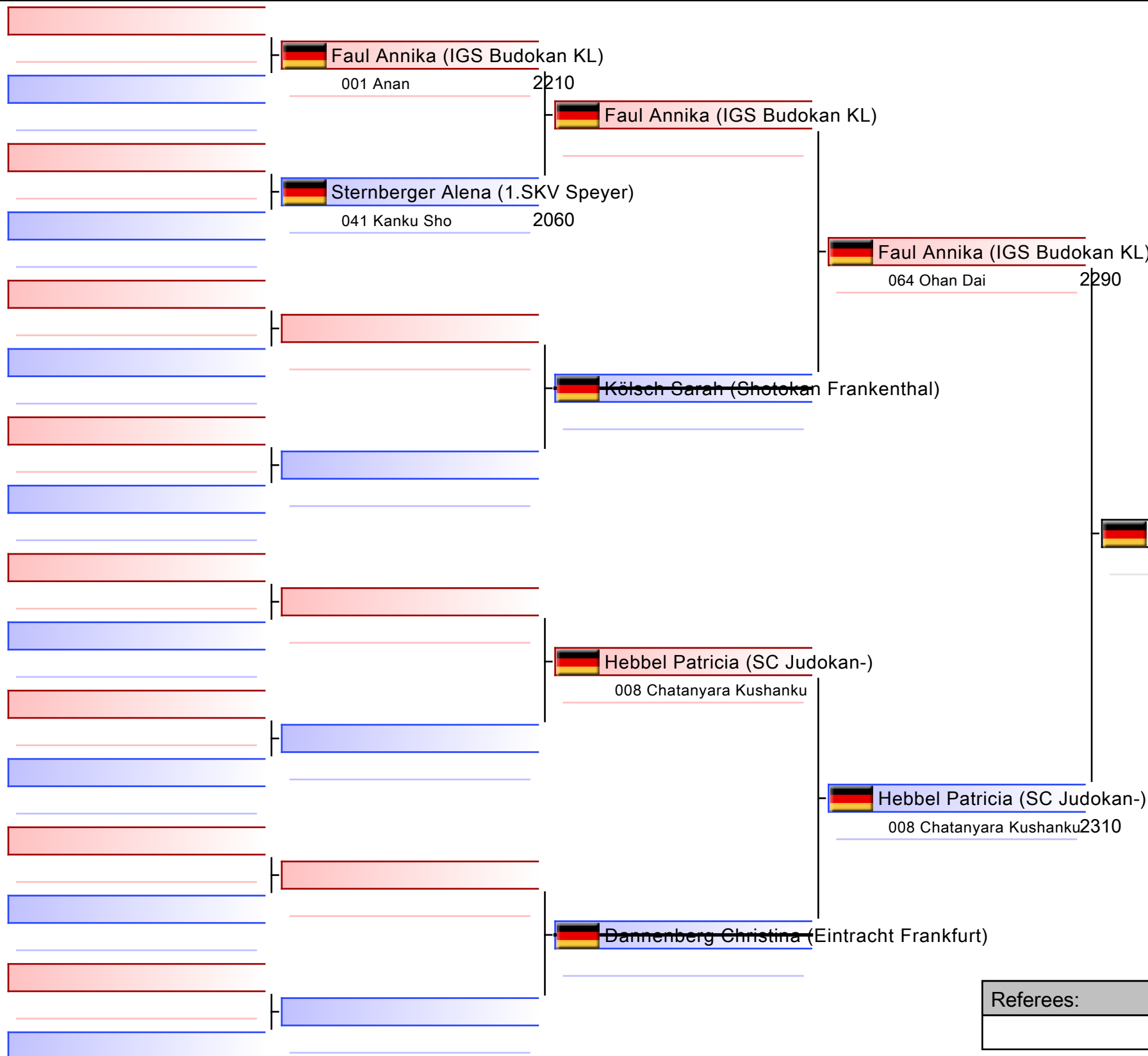

|                                    |
|------------------------------------|
| 1. HEBBEL PATRICIA (SC JUDOKAN-)   |
| 2. GRIESEL CAROLINA (1.SKV SPEYER) |
| 3. FAUL ANNIKA (IGS BUDOKAN KL)    |
| 3. DIELMANN JESSICA (SC JUDOKAN-)  |
| 5. BOSSERDT VANESSA (KDMM)         |
| 7. KRAWCZYK JULIA (BCRN E.V.)      |
|                                    |
|                                    |

|           |  |  |  |
|-----------|--|--|--|
| Referees: |  |  |  |
|           |  |  |  |

# Poolieger-U21 Kata Damen

Offene Landesmeisterschaft Hessen und Rheinland - Pfalz 2024, Schulstraße 2, 69509 Mörlenbach, GER

Tatami

Pool

1/1

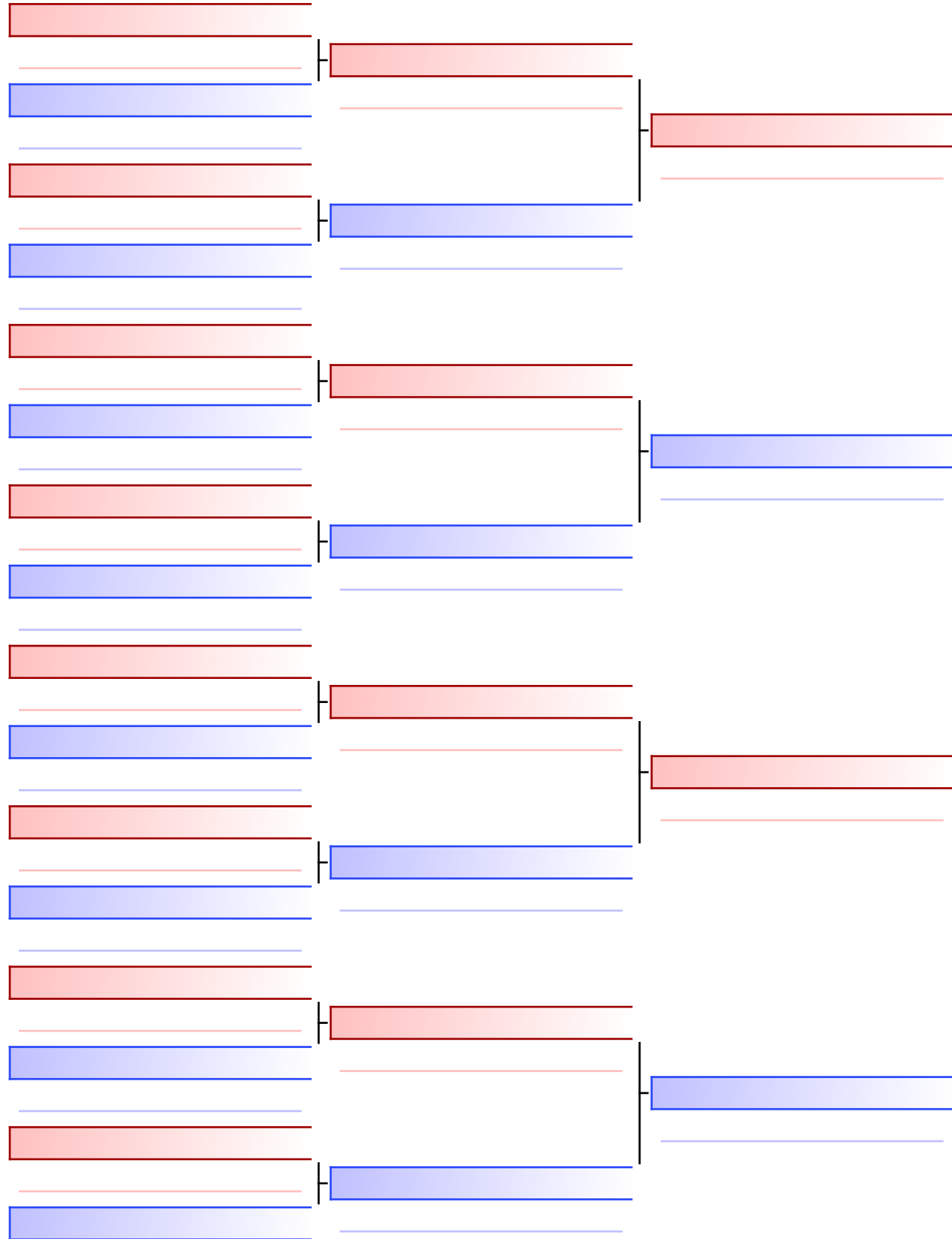

## Finale

Griessel Carolina (1.SKV Speyer)  
015 Gankaku 3960

Hebbel Patricia (SC Judokan-)

Hebbel Patricia (SC Judokan-)  
064 Ohan Dai 4090

|                                    |
|------------------------------------|
| 1. HEBBEL PATRICIA (SC JUDOKAN-)   |
| 2. GRIESEL CAROLINA (1.SKV SPEYER) |
| 3. FAUL ANNIKA (IGS BUDOKAN KL)    |
| 3. DIELMANN JESSICA (SC JUDOKAN-)  |
| 5. BOSSERDT VANESSA (KDMM)         |
| 7. KRAWCZYK JULIA (BCRN E.V.)      |
|                                    |
|                                    |

|           |  |  |  |
|-----------|--|--|--|
| Referees: |  |  |  |
|           |  |  |  |

# U21 Kata Damen

Offene Landesmeisterschaft Hessen und Rheinland - Pfalz 2024

2024-02-03

Tatami

4 11:30

Pool

1,2

(c)sportdata GmbH & Co KG 2000-2024 (2024-02-04 18:16) v 10.1.0 build 1 (2024-01-30 21:40 CET) Lizenz: Online\_Event\_ID-7816\_OffeneLandesmeisterschaftHessenundRheinlandPfalz2024 (expire 2024-02-18)

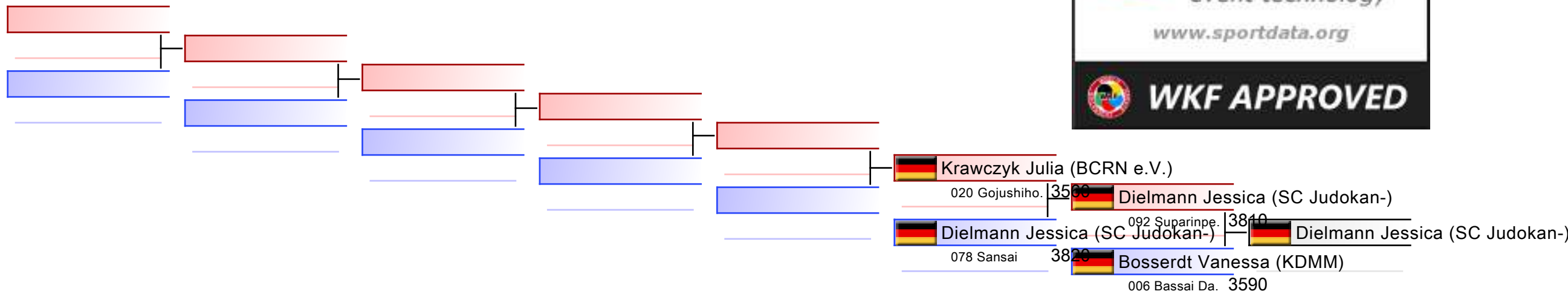

## TROSTRUNDE: (1,2)

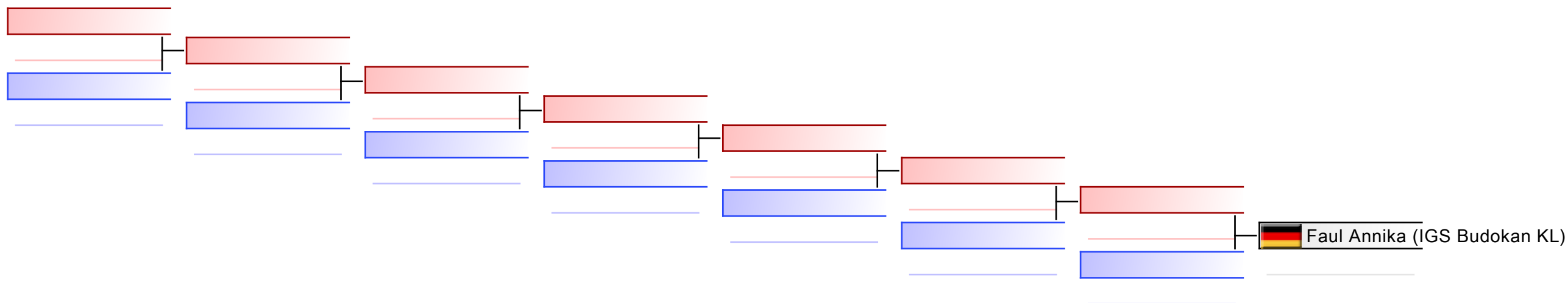

|           |  |  |  |  |  |  |  |
|-----------|--|--|--|--|--|--|--|
| Referees: |  |  |  |  |  |  |  |
|-----------|--|--|--|--|--|--|--|

# U21 Kata Damen

Offene Landesmeisterschaft Hessen und Rheinland - Pfalz 2024

2024-02-03

Tatami  
4 11:45

Pool  
2

(c)sportdata GmbH & Co KG 2000-2024 (2024-02-04 18:16) v 10.1.0 build 1 (2024-01-30 21:40 CET) Lizenz: Online\_Event\_ID-7816\_OffeneLandesmeisterschaftHessenundRheinlandPfalz2024 (expire 2024-02-18)

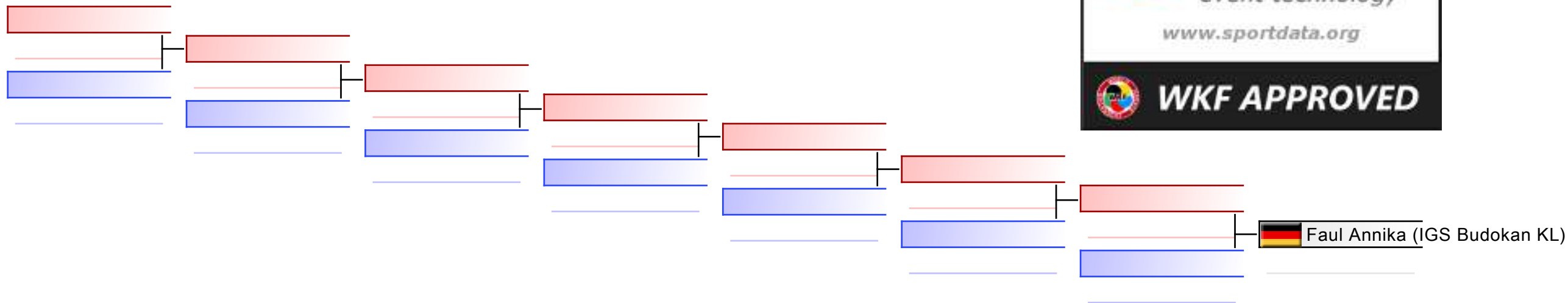

## TROSTRUNDE: (2)

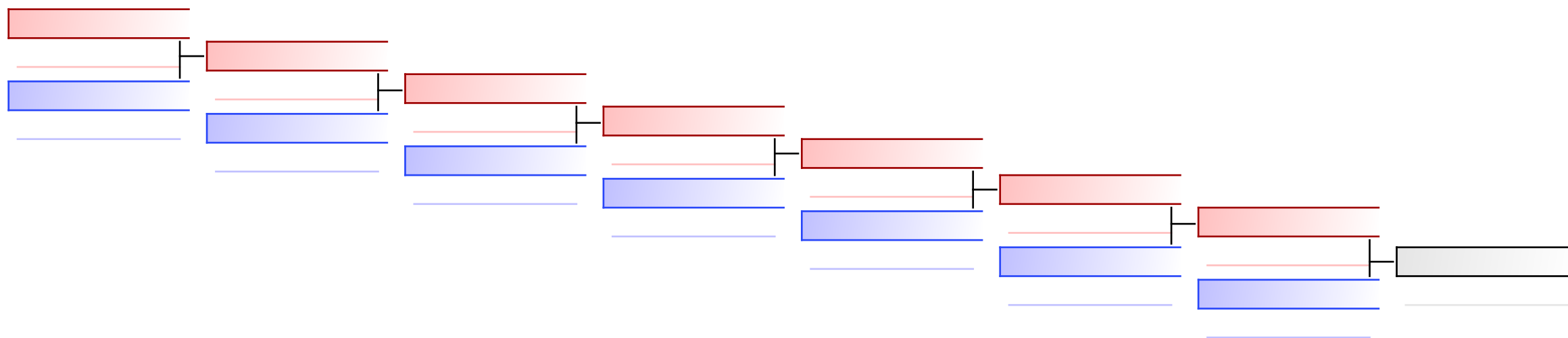

|           |  |  |  |  |  |  |  |
|-----------|--|--|--|--|--|--|--|
| Referees: |  |  |  |  |  |  |  |
|-----------|--|--|--|--|--|--|--|



Offene Landesmeisterschaft Hessen  
und Rheinland - Pfalz 2024 - 2024-02-03

Offizielle Ergebnisliste

| U21 Kata Damen |                  |  |   |               |
|----------------|------------------|--|---|---------------|
| 1              | HEBBEL PATRICIA  | SC JUDOKAN E.V.                        |  | GER - GERMANY |
| 2              | GRIESEL CAROLINA | 1. SHOTOKAN<br>KARATE VEREIN<br>SPEYER |  | GER - GERMANY |
| 3              | FAUL ANNIKA      | IGS BUDOKAN<br>KAISERSLAUTERN          |  | GER - GERMANY |
| 3              | DIELMANN JESSICA | SC JUDOKAN E.V.                        |  | GER - GERMANY |
| 5              | BOSSERDT VANESSA | KARATE DOJO<br>MAYEN-MENDIG            |  | GER - GERMANY |
| 7              | KRAWCZYK JULIA   | BUDOCLUB RHEIN-<br>NECKAR E.V.         |  | GER - GERMANY |

# U21 KATA HERREN





# Offene Landesmeisterschaft Hessen und Rheinland -..

## ENTRIES BY WEIGHT CATEGORY

### U21 Kata Herren

As of 4 FEB 2024

| NOC Code | Gender | Name                     | Seeding |
|----------|--------|--------------------------|---------|
| GER      | M      | Hadizadeh Julian Fabrice |         |
| GER      | M      | Heuser Nick              |         |
| GER      | M      | Kheiri-Ahvazi Nima       |         |
| GER      | M      | Liedy Jonas-Pascal       |         |
| GER      | M      | Seitz Noel               |         |
| GER      | M      | Ziza Rayan               |         |

# U21 Kata Herren

Offene Landesmeisterschaft Hessen und Rheinland - Pfalz 2024, Schulstraße 2, 69509 Mörlenbach, GER

2024-02-03

Tatami  
1 11:00

Pool  
1/1

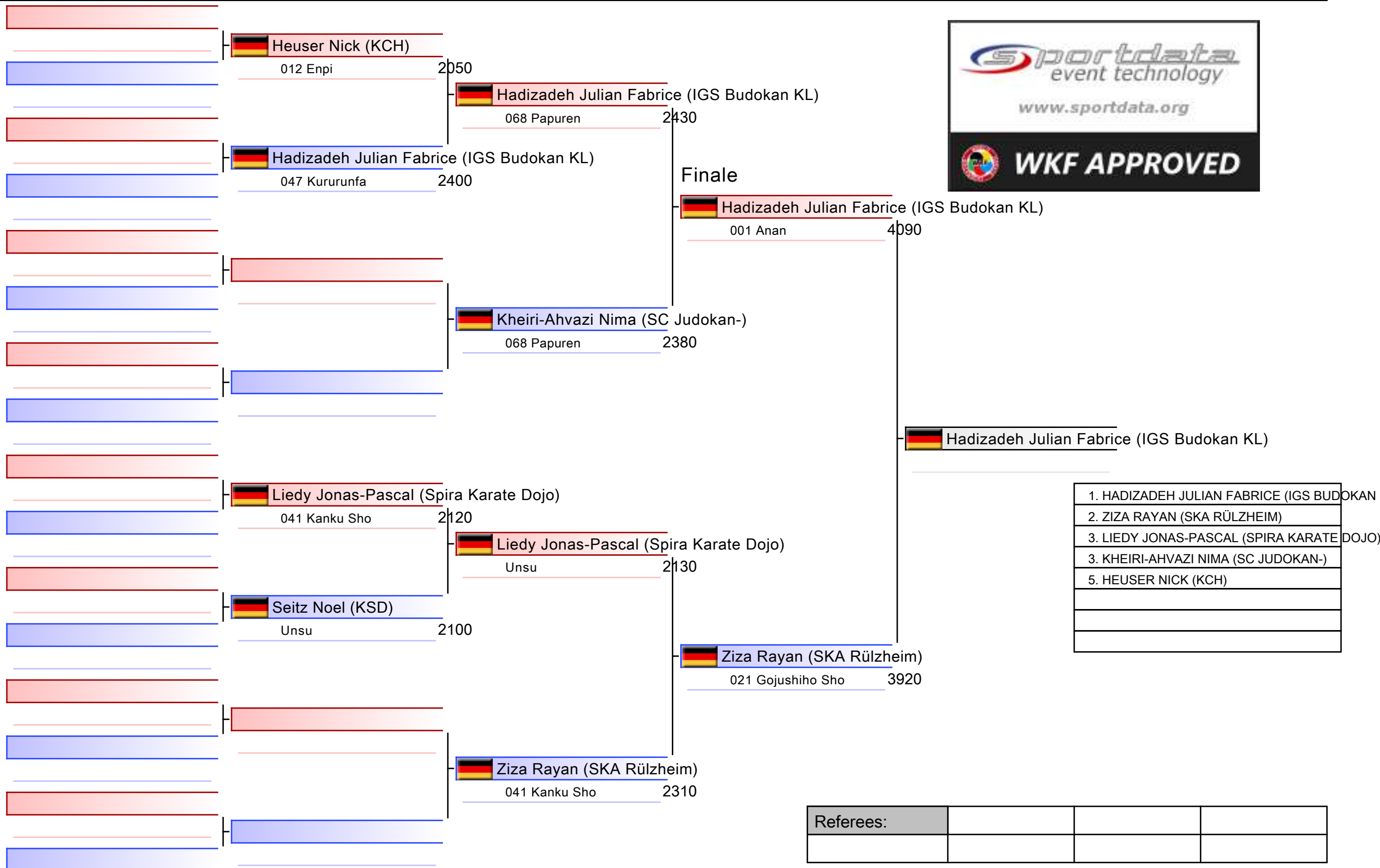

# U21 Kata Herren

Offene Landesmeisterschaft Hessen und Rheinland - Pfalz 2024

2024-02-03

Tatami

1 11:25

Pool

1

(c)sportdata GmbH & Co KG 2000-2024 (2024-02-04 18:16) v 10.1.0 build 1 (2024-01-30 21:40 CET) Lizenz: Online\_Event\_ID-7816\_OffeneLandesmeisterschaftHessenundRheinlandPfalz2024 (expire 2024-02-18)

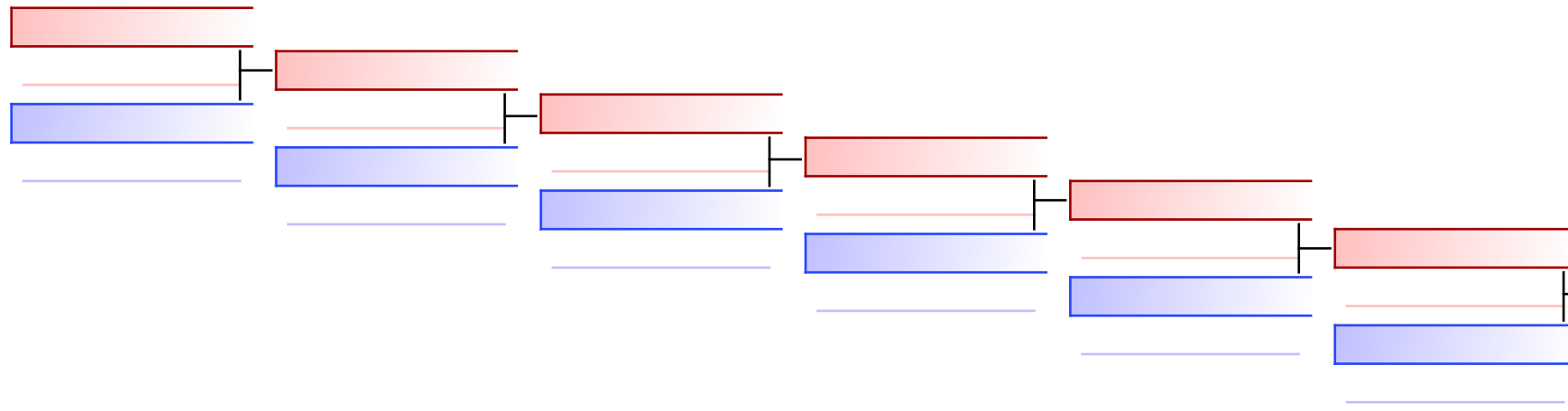

Heuser Nick (KCH)  
021 Gojushiho. 2100

Kheiri-Ahvazi Nima (SC Judokan)  
 Kheiri-Ahvazi Nima (SC Judokan-)  
001 Anan 2400

## TROSTRUNDE: (1)

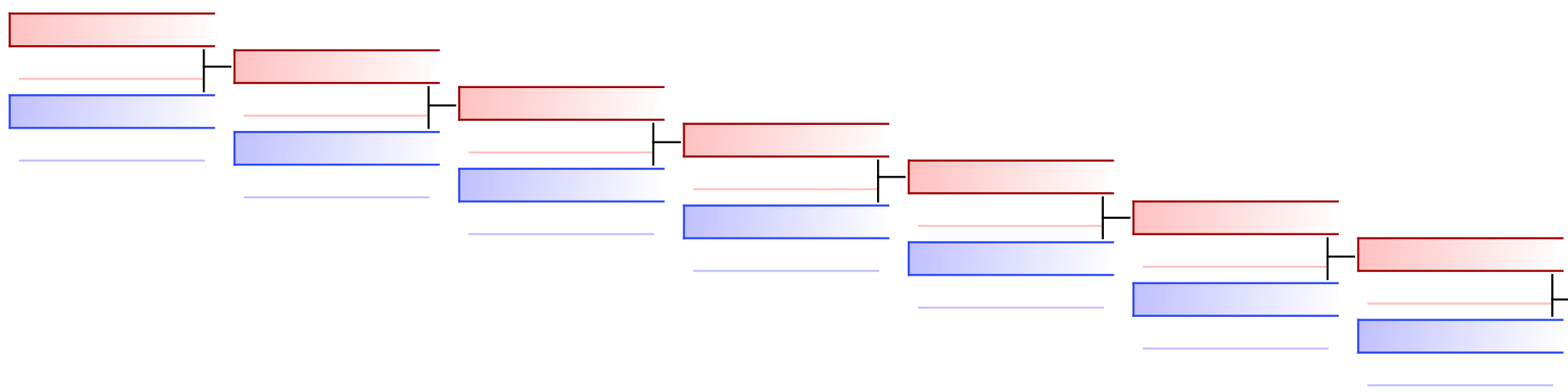

Liedy Jonas-Pascal (Spira Karate)

|           |  |  |  |  |  |  |  |
|-----------|--|--|--|--|--|--|--|
| Referees: |  |  |  |  |  |  |  |
|-----------|--|--|--|--|--|--|--|



Offene Landesmeisterschaft Hessen  
und Rheinland - Pfalz 2024 - 2024-02-03

Offizielle Ergebnisliste

| U21 Kata Herren |                          |   |  |               |  |
|-----------------|--------------------------|---|--|---------------|--|
| 1               | HADIZADEH JULIAN FABRICE | IGS BUDOKAN<br>KAISERSLAUTERN                     |  | GER - GERMANY |  |
| 2               | ZIZA RAYAN               | SHOTOKAN<br>RYU KARATE<br>DO AKADEMIE<br>RÜLZHEIM |  | GER - GERMANY |  |
| 3               | LIEDY JONAS-PASCAL       | SHOTOKAN KARATE<br>DOJO SPIRA E.V.                |  | GER - GERMANY |  |
| 3               | KHEIRI-AHVAZI NIMA       | SC JUDOKAN E.V.                                   |  | GER - GERMANY |  |
| 5               | HEUSER NICK              | KARATE CLUB<br>HATTERSHEIM                        |  | GER - GERMANY |  |

# U21 KUMITE DAMEN -50 KG



# Offene Landesmeisterschaft Hessen und Rheinland -..

## ENTRIES BY WEIGHT CATEGORY

U21 Kumite Damen -50 kg

As of 4 FEB 2024

| NOC Code | Gender | Name             | Seeding |
|----------|--------|------------------|---------|
| GER      | F      | Brettnacher Lara |         |
| GER      | F      | Reis Nele        |         |
| GER      | F      | Sikavica Dora    |         |

# U21 Kumite Damen -50 kg

Offene Landesmeisterschaft Hessen und Rheinland - Pfalz 2024, Schulstraße 2, 69509 Mörlenbach, GER

Tatami

Pool

1/1

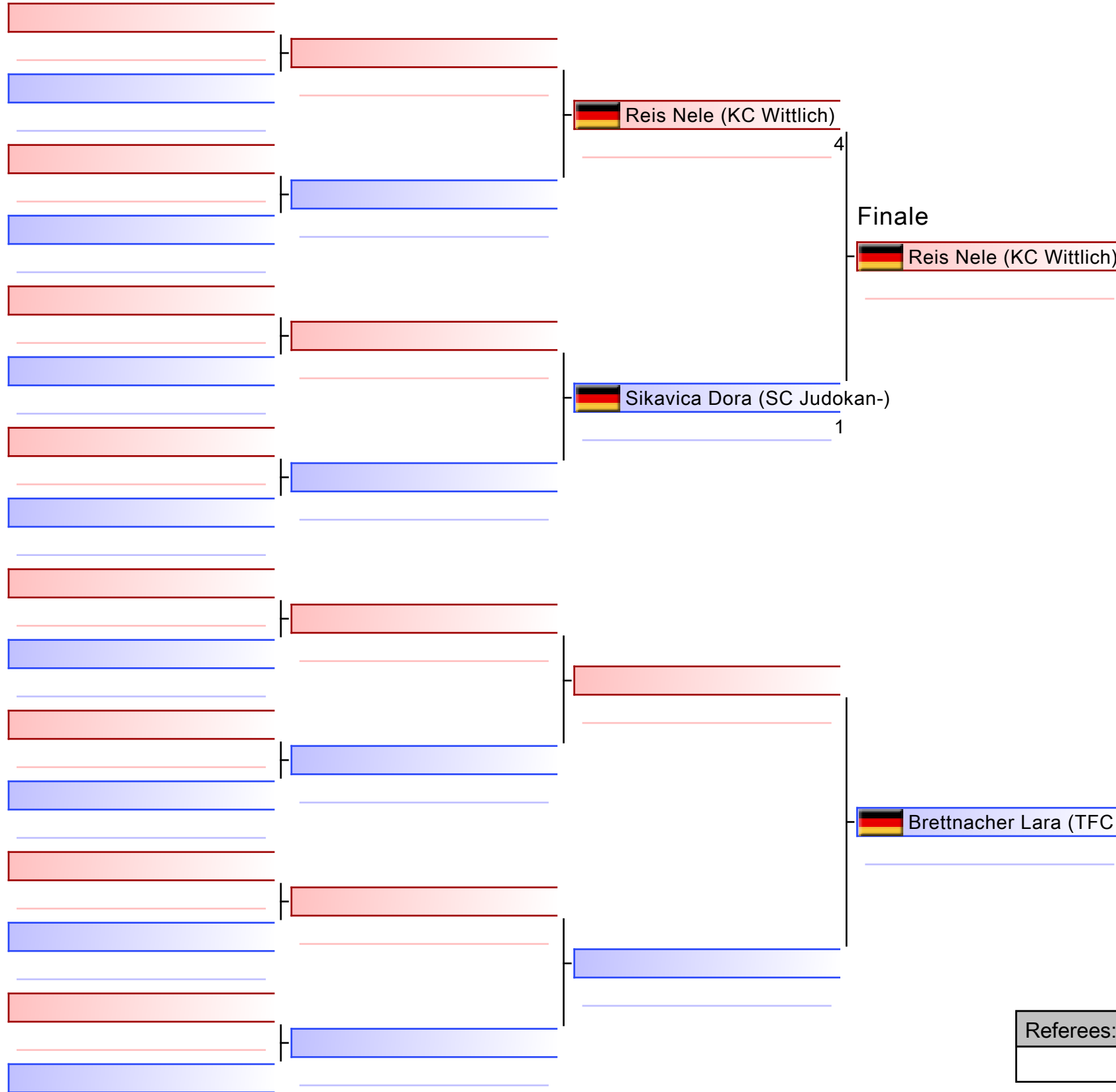

|                                      |
|--------------------------------------|
| 1. BRETTNACHER LARA (TFC WESTERWALD) |
| 2. REIS NELE (KC WITTLICH)           |
|                                      |
|                                      |
|                                      |
|                                      |
|                                      |

|           |  |  |  |
|-----------|--|--|--|
| Referees: |  |  |  |
|           |  |  |  |



Offene Landesmeisterschaft Hessen  
und Rheinland - Pfalz 2024 - 2024-02-03

Offizielle Ergebnisliste

| U21 Kumite Damen -50 kg |                  |                              |   |               |
|-------------------------|------------------|------------------------------|---|---------------|
| 1                       | BRETTNACHER LARA | TEAM FIGHTCLUB<br>WESTERWALD |  | GER - GERMANY |
| 2                       | REIS NELE        | KARATE CLUB<br>WITTLICH      |  | GER - GERMANY |



# U21 KUMITE DAMEN -55 KG



# Offene Landesmeisterschaft Hessen und Rheinland -..

## ENTRIES BY WEIGHT CATEGORY

U21 Kumite Damen -55 kg

As of 4 FEB 2024

| NOC Code | Gender | Name          | Seeding |
|----------|--------|---------------|---------|
| GER      | F      | Hasic Minela  |         |
| GER      | F      | Hoffmann Maja |         |
| GER      | F      | Sikavica Dora |         |

# U21 Kumite Damen -55 kg

Offene Landesmeisterschaft Hessen und Rheinland - Pfalz 2024, Schulstraße 2, 69509 Mörlenbach, GER

2024-02-03

Tatami  
2 15:15

Pool  
1/1

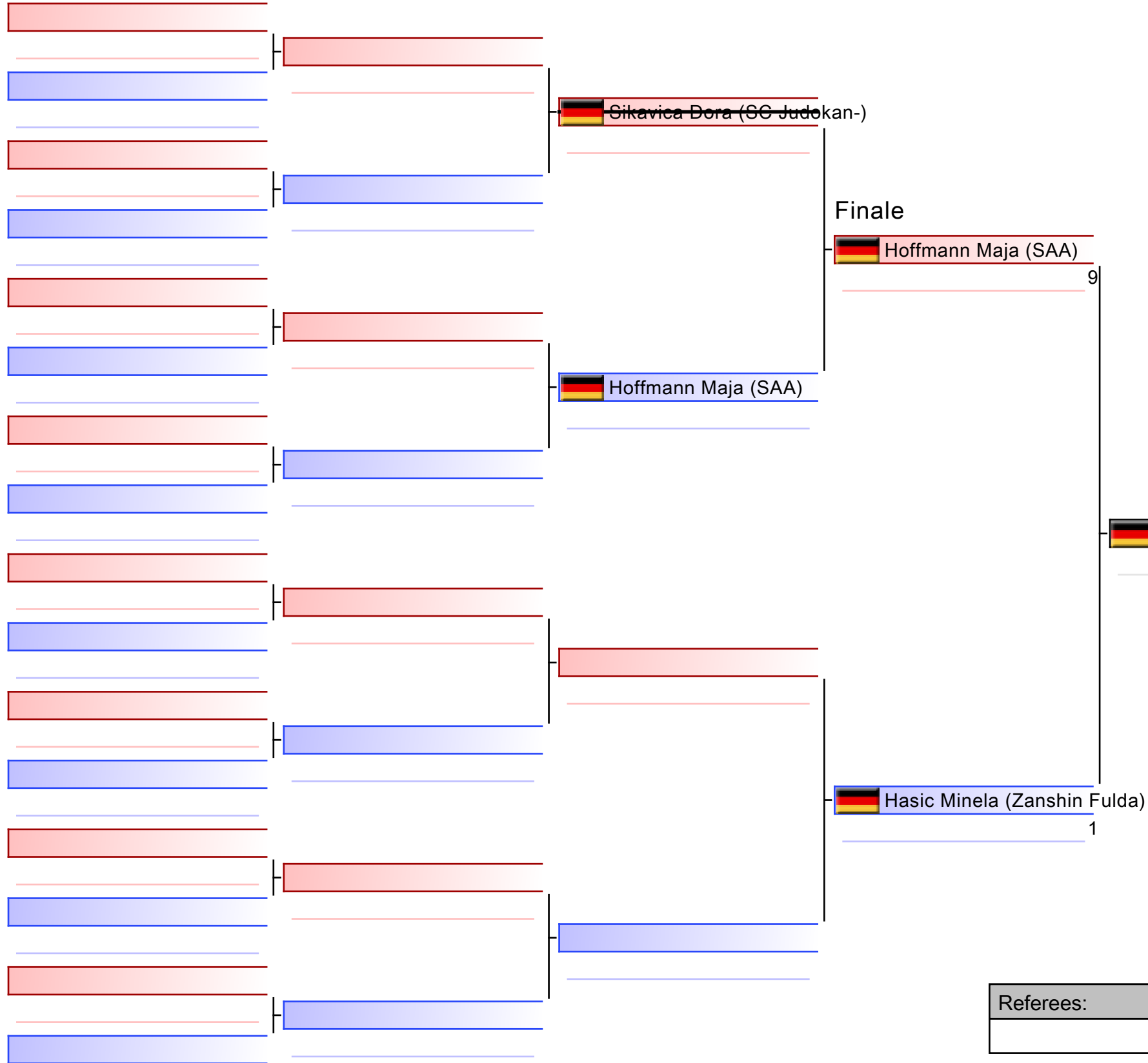

|                                 |
|---------------------------------|
| 1. HOFFMANN MAJA (SAA)          |
| 2. HASIC MINELA (ZANSHIN FULDA) |
| 3. SIKAVICA DORA (SC JUDOKAN-)  |
|                                 |
|                                 |
|                                 |
|                                 |

|           |  |  |  |
|-----------|--|--|--|
| Referees: |  |  |  |
|           |  |  |  |



Offene Landesmeisterschaft Hessen  
und Rheinland - Pfalz 2024 - 2024-02-03

Offizielle Ergebnisliste

| U21 Kumite Damen -55 kg |               |   |   |               |
|-------------------------|---------------|---|---|---------------|
| 1                       | HOFFMANN MAJA | SAARLÄNDISCHER<br>KARATE- VERBAND<br>E.V. |  | GER - GERMANY |
| 2                       | HASIC MINELA  | ZANSHIN GRÜN-<br>WEISS FULDA              |  | GER - GERMANY |
| 3                       | SIKAVICA DORA | SC JUDOKAN E.V.                           |  | GER - GERMANY |



# U21 KUMITE DAMEN -61 KG



# Offene Landesmeisterschaft Hessen und Rheinland -..

## ENTRIES BY WEIGHT CATEGORY

U21 Kumite Damen -61 kg

As of 4 FEB 2024

| NOC Code | Gender | Name          | Seeding |
|----------|--------|---------------|---------|
| GER      | F      | Weiler Mariel |         |
| GER      | F      | Worms Lara    |         |

# U21 Kumite Damen -61 kg

Offene Landesmeisterschaft Hessen und Rheinland - Pfalz 2024, Schulstraße 2, 69509 Mörlenbach, GER

2024-02-03

Tatami  
3 16:45

Pool  
1/1

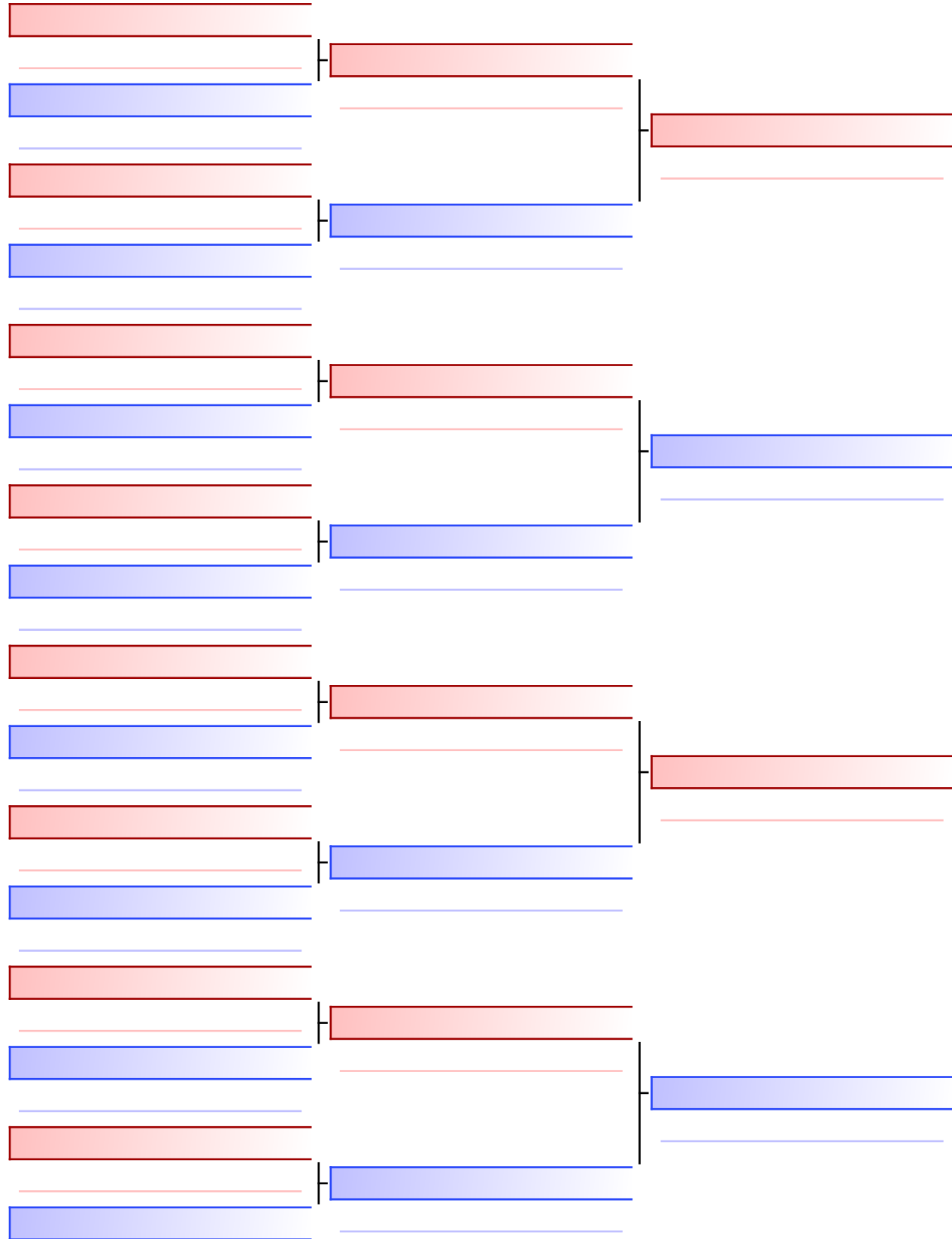

## Finale

 Weiler Mariel (KSC Puderbach)

0

 Weiler Mariel (KSC Puderbach)

 Worms Lara (KDD)

0

1. WEILER MARIEL (KSC PUDERBACH)

|                                  |
|----------------------------------|
| 1. WEILER MARIEL (KSC PUDERBACH) |
|                                  |
|                                  |
|                                  |
|                                  |
|                                  |
|                                  |
|                                  |

|           |  |  |  |
|-----------|--|--|--|
| Referees: |  |  |  |
|           |  |  |  |



Offene Landesmeisterschaft Hessen  
und Rheinland - Pfalz 2024 - 2024-02-03

Offizielle Ergebnisliste

| U21 Kumite Damen -61 kg |               |                              |   |               |
|-------------------------|---------------|------------------------------|---|---------------|
| 1                       | WEILER MARIEL | KARATE TEAM KSC<br>PUDERBACH |  | GER - GERMANY |



# U21 KUMITE DAMEN -68/+68KG



# Offene Landesmeisterschaft Hessen und Rheinland -..

## ENTRIES BY WEIGHT CATEGORY

### U21 Kumite Damen -68/+68kg

As of 4 FEB 2024

| NOC Code | Gender | Name                      | Seeding |
|----------|--------|---------------------------|---------|
| GER      | F      | Eizadyariaghmiyouni Paria |         |
| GER      | F      | Scherer Johanna           |         |

# U21 Kumite Damen -68/+68kg

Offene Landesmeisterschaft Hessen und Rheinland - Pfalz 2024, Schulstraße 2, 69509 Mörlenbach, GER

Tatami

Pool

1/1

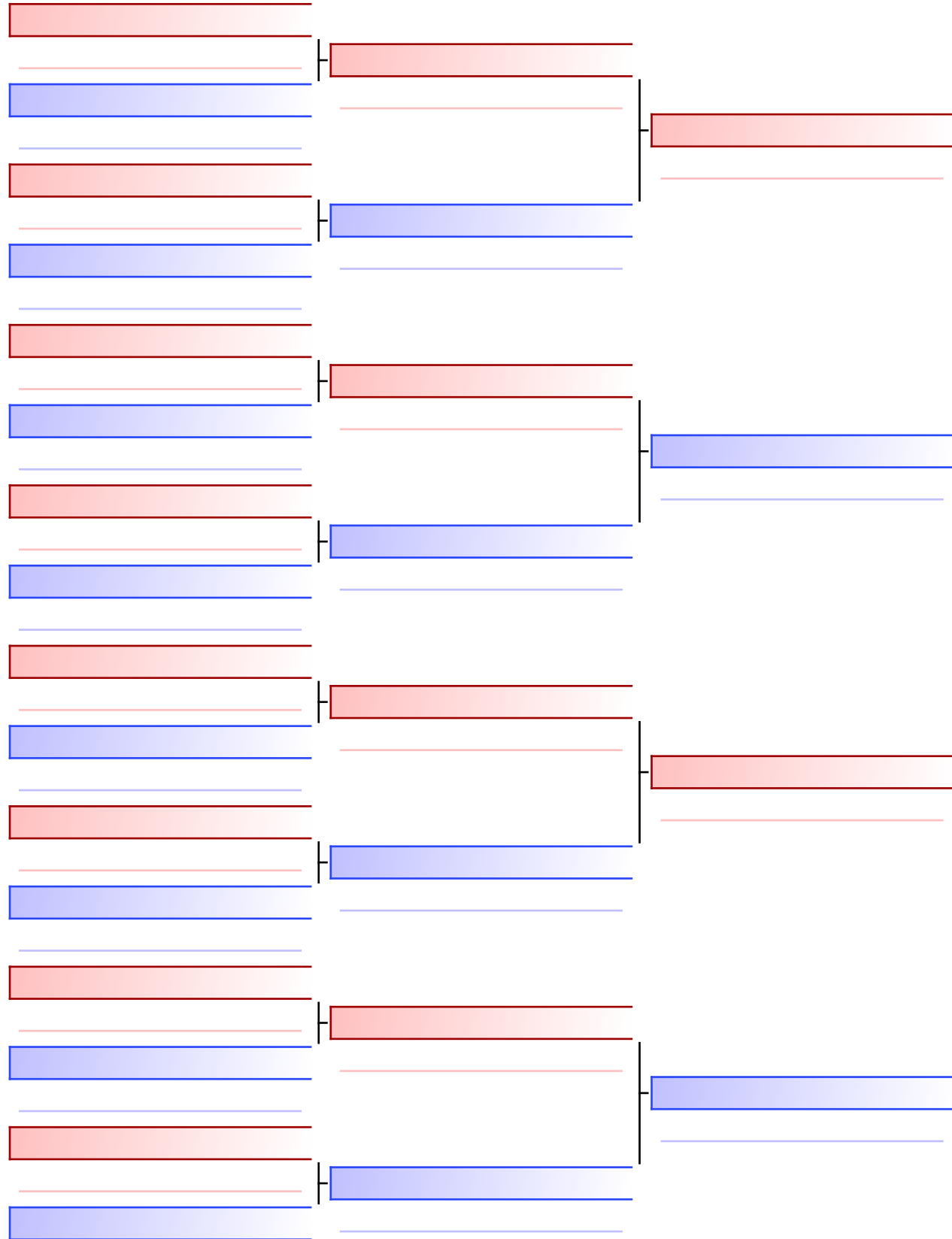

Finale

 Scherer Johanna (SAA)

1

 Eizadyariaghmiyouni Paria (KV FB)

 Eizadyariaghmiyouni Paria (KV FB)

5

1. EIZADYARIAGHMIYOUNI PARIA (KV FB)

2. SCHERER JOHANNA (SAA)

Referees:

|  |  |  |  |
|--|--|--|--|
|  |  |  |  |
|  |  |  |  |



Offene Landesmeisterschaft Hessen  
und Rheinland - Pfalz 2024 - 2024-02-03

Offizielle Ergebnisliste

| U21 Kumite Damen -68/+68kg |                           |   |   |               |
|----------------------------|---------------------------|---|---|---------------|
| 1                          | EIZADYARIAGHMIYOUNI PARIA | KARATEVEREIN<br>FRIEDBERG                 |  | GER - GERMANY |
| 2                          | SCHERER JOHANNA           | SAARLÄNDISCHER<br>KARATE- VERBAND<br>E.V. |  | GER - GERMANY |

# U21 KUMITE HERREN -60 KG



# Offene Landesmeisterschaft Hessen und Rheinland -..

## ENTRIES BY WEIGHT CATEGORY

U21 Kumite Herren -60 kg

As of 4 FEB 2024

| NOC Code | Gender | Name                 | Seeding |
|----------|--------|----------------------|---------|
| GER      | M      | Blumenauer Alec      |         |
| GER      | M      | Egerland Marvin-Luca |         |

# U21 Kumite Herren -60 kg

Offene Landesmeisterschaft Hessen und Rheinland - Pfalz 2024, Schulstraße 2, 69509 Mörlenbach, GER

Tatami

Pool

1/1

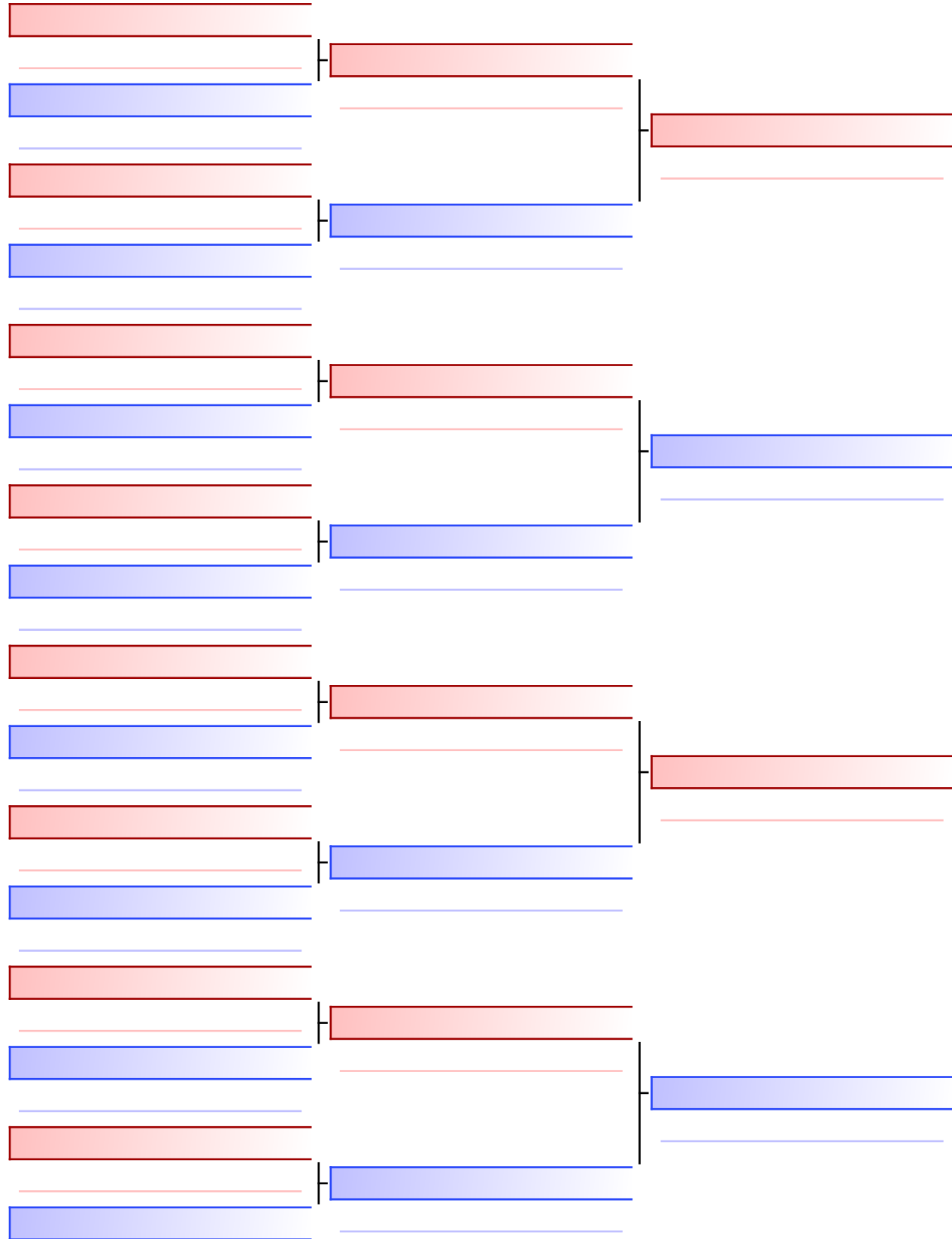

Finale

 Blumenauer Alec (Sen5)

9

 Blumenauer Alec (Sen5)

 Egerland Marvin-Luca (GR Schifferstadt)

4

|  |
|--|
| 1. BLUMENAUER ALEC (SEN5)                  |
| 2. EGERLAND MARVIN-LUCA (GR SCHIFFERSTADT) |
|  |
|  |
|  |
|  |
|  |

|           |  |  |  |
|-----------|--|--|--|
| Referees: |  |  |  |
|           |  |  |  |



Offene Landesmeisterschaft Hessen  
und Rheinland - Pfalz 2024 - 2024-02-03

Offizielle Ergebnisliste

| U21 Kumite Herren -60 kg |                      |  |   |               |
|--------------------------|----------------------|--|---|---------------|
| 1                        | BLUMENAUER ALEC      | SEN5 KARATE<br>VEREIN E.V.                     |  | GER - GERMANY |
| 2                        | EGERLAND MARVIN-LUCA | GOJU-RYU<br>KARATEVEREIN<br>SCHIFFERSTADT E.V. |  | GER - GERMANY |





# U21 KUMITE HERREN -67 KG



# Offene Landesmeisterschaft Hessen und Rheinland -..

## ENTRIES BY WEIGHT CATEGORY

U21 Kumite Herren -67 kg

As of 4 FEB 2024

| NOC Code | Gender | Name                   | Seeding |
|----------|--------|------------------------|---------|
| GER      | M      | Alkatep Ahmad          |         |
| GER      | M      | Hamrodi Jan            |         |
| GER      | M      | Popa Alexandru-Gabriel |         |
| GER      | M      | Quadt Lukas            |         |
| GER      | M      | Thran Melvin           |         |

# U21 Kumite Herren -67 kg

Offene Landesmeisterschaft Hessen und Rheinland - Pfalz 2024, Schulstraße 2, 69509 Mörlenbach, GER

2024-02-03

Tatami  
6 15:00

Pool  
1/1

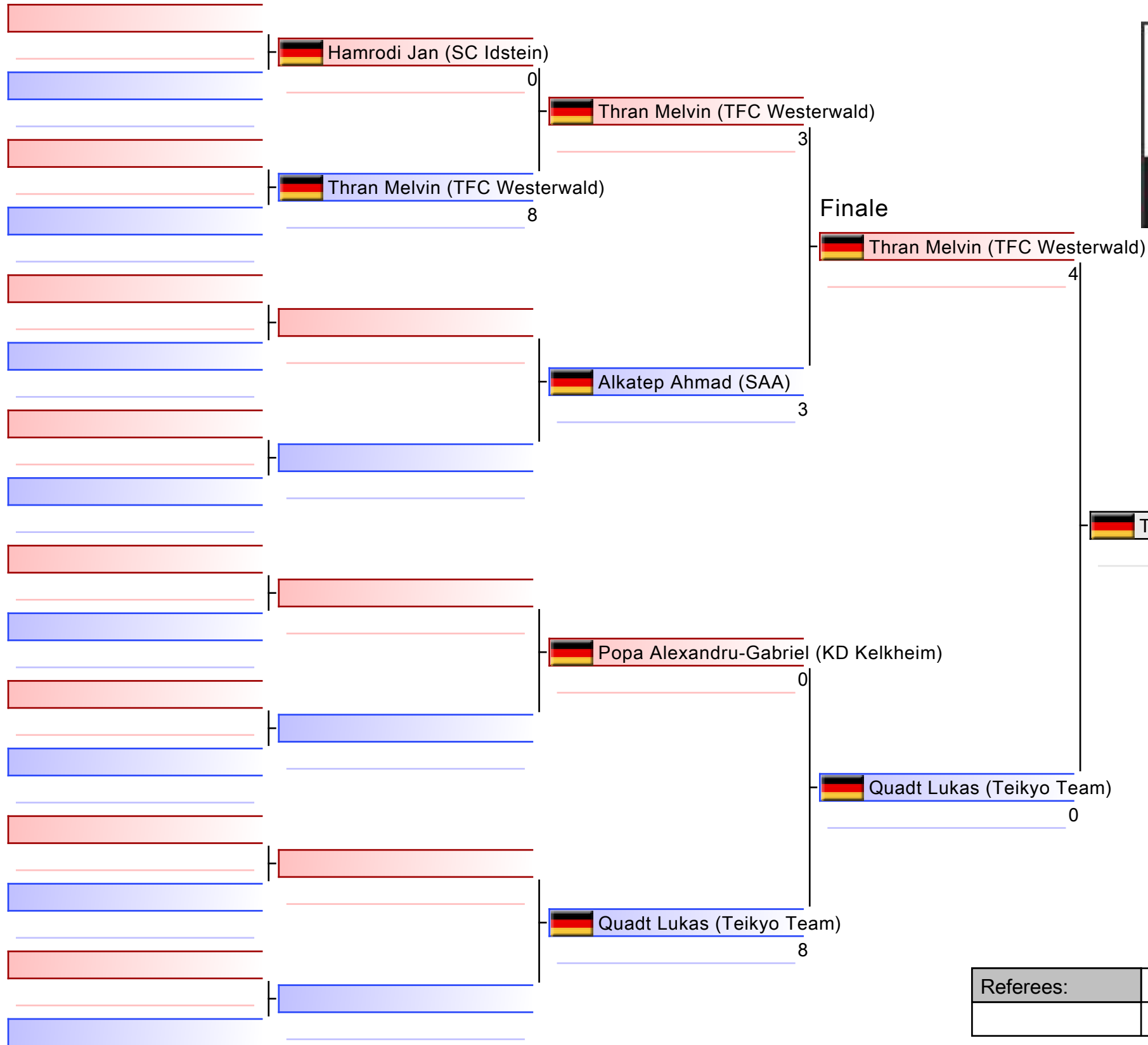

|   |
|---|
| 1. THRAN MELVIN (TFC WESTERWALD)        |
| 2. QUADT LUKAS (TEIKYO TEAM)            |
| 3. POPA ALEXANDRU-GABRIEL (KD KELKHEIM) |
| 3. ALKATEP AHMAD (SAA)                  |
| 5. HAMRODI JAN (SC IDSTEIN)             |
|   |
|   |

|           |  |  |  |
|-----------|--|--|--|
| Referees: |  |  |  |
|           |  |  |  |

# U21 Kumite Herren -67 kg

Offene Landesmeisterschaft Hessen und Rheinland - Pfalz 2024

2024-02-03

Tatami  
6 15:20

Pool  
1

(c)sportdata GmbH & Co KG 2000-2024 (2024-02-04 18:16) v 10.1.0 build 1 (2024-01-30 21:40 CET) Lizenz: Online\_Event\_ID-7816\_OffeneLandesmeisterschaftHessenundRheinlandPfalz2024 (expire 2024-02-18)

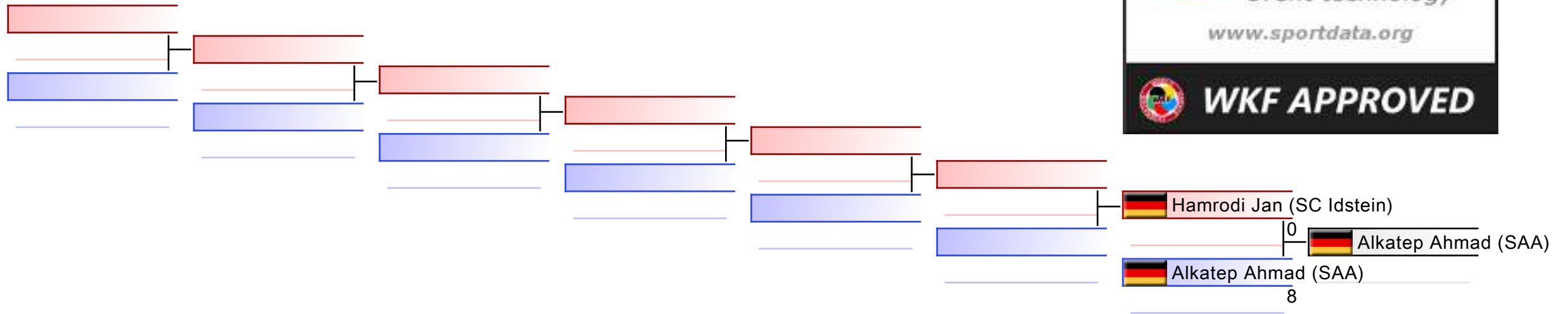

## TROSTRUNDE: (1)

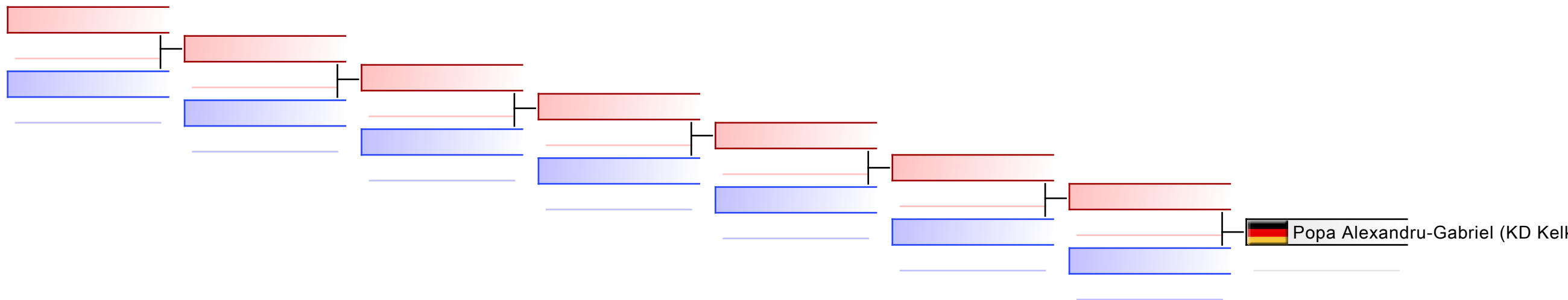

|           |  |  |  |  |  |  |  |
|-----------|--|--|--|--|--|--|--|
| Referees: |  |  |  |  |  |  |  |
|-----------|--|--|--|--|--|--|--|



Offene Landesmeisterschaft Hessen  
und Rheinland - Pfalz 2024 - 2024-02-03

Offizielle Ergebnisliste

| U21 Kumite Herren -67 kg |                        |   |   |               |
|--------------------------|------------------------|---|---|---------------|
| 1                        | THRAN MELVIN           | TEAM FIGHTCLUB<br>WESTERWALD              |  | GER - GERMANY |
| 2                        | QUADT LUKAS            | TEIKYO KARATE<br>TEAM E.V.                |  | GER - GERMANY |
| 3                        | POPA ALEXANDRU-GABRIEL | KARATE-DOJO<br>KELKHEIM E.V.              |  | GER - GERMANY |
| 3                        | ALKATEP AHMAD          | SAARLÄNDISCHER<br>KARATE- VERBAND<br>E.V. |  | GER - GERMANY |
| 5                        | HAMRODI JAN            | SC IDSTEIN                                |  | GER - GERMANY |

# U21 KUMITE HERREN -75 KG



# Offene Landesmeisterschaft Hessen und Rheinland -..

## ENTRIES BY WEIGHT CATEGORY

U21 Kumite Herren -75 kg

As of 4 FEB 2024

| NOC Code | Gender | Name                | Seeding |
|----------|--------|---------------------|---------|
| GER      | M      | Beyersdörfer Philip |         |
| GER      | M      | Schmauder Julius    |         |

# U21 Kumite Herren -75 kg

Offene Landesmeisterschaft Hessen und Rheinland - Pfalz 2024, Schulstraße 2, 69509 Mörlenbach, GER

Tatami

Pool

1/1

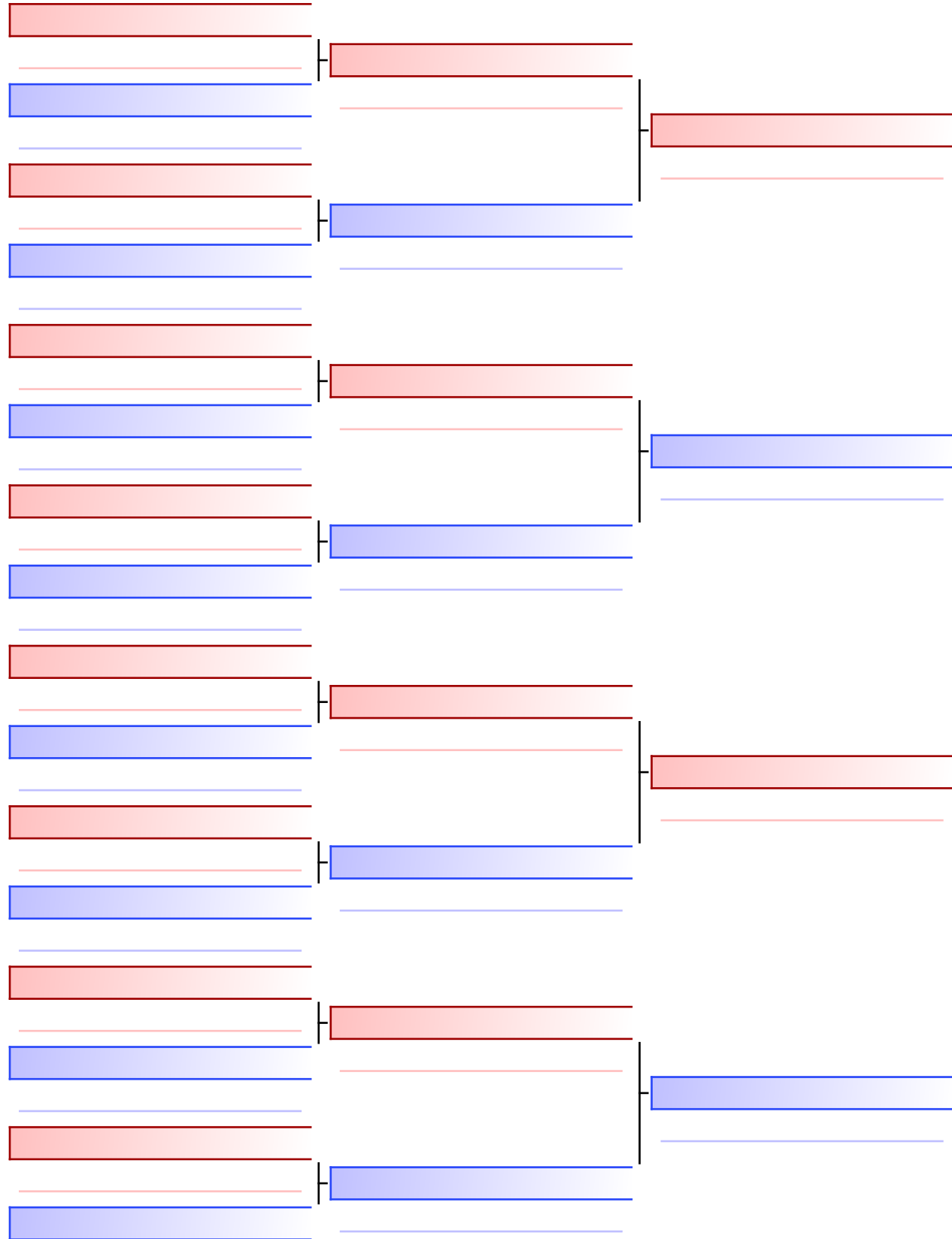

## Finale

 Schmauder Julius (KVL)

1

 Beyersdörfer Philip (Teikyo Team)

 Beyersdörfer Philip (Teikyo Team)

9

|                                      |
|--------------------------------------|
| 1. BEYERSDÖRFER PHILIP (TEIKYO TEAM) |
| 2. SCHMAUDER JULIUS (KVL)            |
|                                      |
|                                      |
|                                      |
|                                      |
|                                      |

|           |  |  |  |
|-----------|--|--|--|
| Referees: |  |  |  |
|           |  |  |  |





Offene Landesmeisterschaft Hessen  
und Rheinland - Pfalz 2024 - 2024-02-03

Offizielle Ergebnisliste

| U21 Kumite Herren -75 kg |                     |                              |   |               |
|--------------------------|---------------------|------------------------------|---|---------------|
| 1                        | BEYERSDÖRFER PHILIP | TEIKYO KARATE<br>TEAM E.V.   |  | GER - GERMANY |
| 2                        | SCHMAUDER JULIUS    | KARATE-VEREIN<br>LANGEN E.V. |  | GER - GERMANY |

# U21 KUMITE HERREN -84/+84KG



# Offene Landesmeisterschaft Hessen und Rheinland -..

## ENTRIES BY WEIGHT CATEGORY

U21 Kumite Herren -84/+84kg

As of 4 FEB 2024

| NOC Code | Gender | Name               | Seeding |
|----------|--------|--------------------|---------|
| GER      | M      | Eul Jan            |         |
| GER      | M      | Müller Elias       |         |
| GER      | M      | Scharf Wlad        |         |
| GER      | M      | Schäfer Timo Maria |         |

# U21 Kumite Herren -84/+84kg

Offene Landesmeisterschaft Hessen und Rheinland - Pfalz 2024, Schulstraße 2, 69509 Mörlenbach, GER

2024-02-03

Tatami  
1 15:10

Pool  
1/1

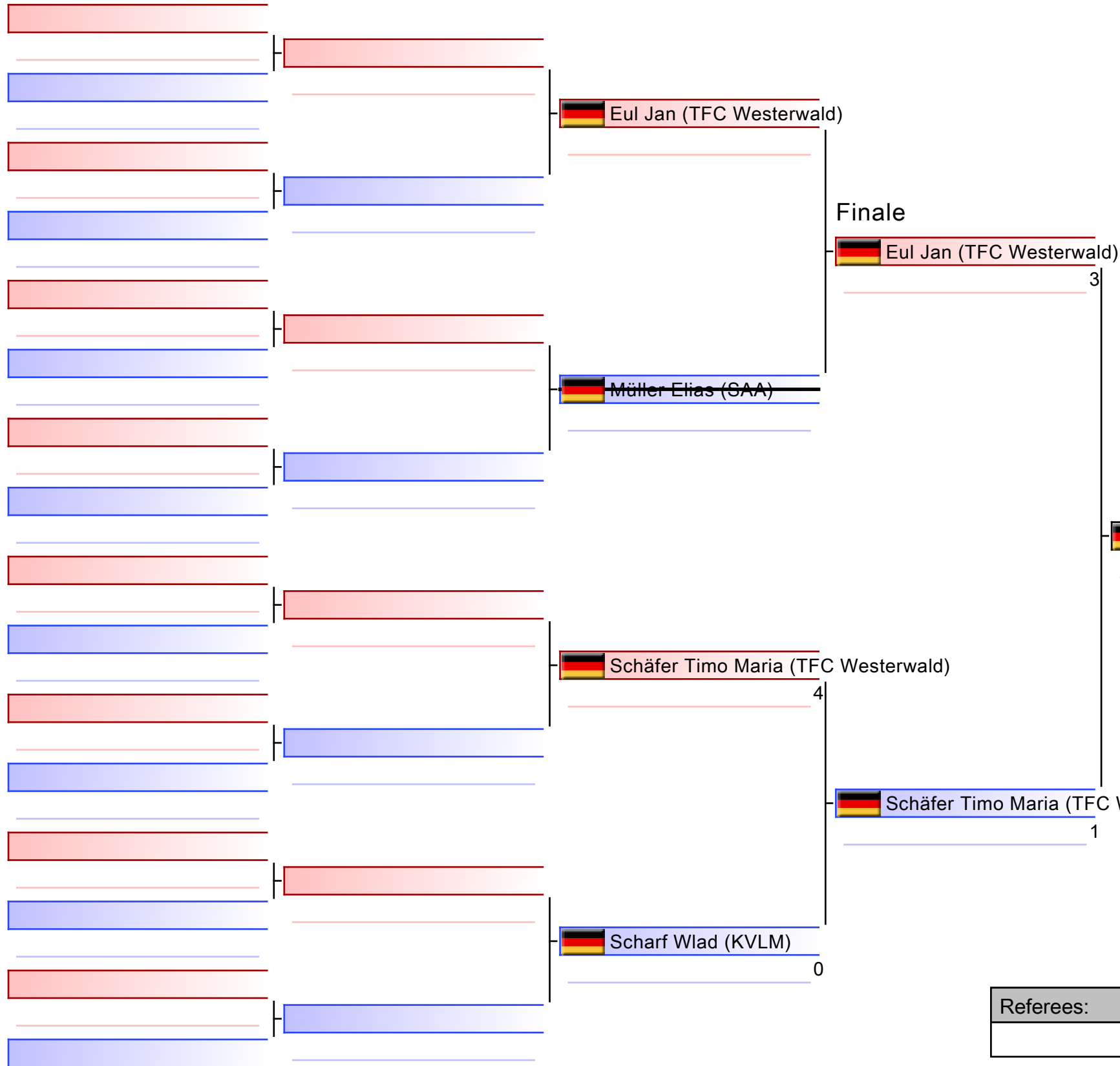

|  |
|--|
| 1. EUL JAN (TFC WESTERWALD)            |
| 2. SCHÄFER TIMO MARIA (TFC WESTERWALD) |
| 3. SCHARF WLAD (KVLM)                  |
|  |
|  |
|  |
|  |

|           |  |  |  |
|-----------|--|--|--|
| Referees: |  |  |  |
|           |  |  |  |

# U21 Kumite Herren -84/+84kg

Offene Landesmeisterschaft Hessen und Rheinland - Pfalz 2024

Tatami

Pool

1

(c)sportdata GmbH & Co KG 2000-2024 (2024-02-04 18:16) v 10.1.0 build 1 (2024-01-30 21:40 CET) Lizenz: Online\_Event\_ID-7816\_OffeneLandesmeisterschaftHessenundRheinlandPfalz2024 (expire 2024-02-18)

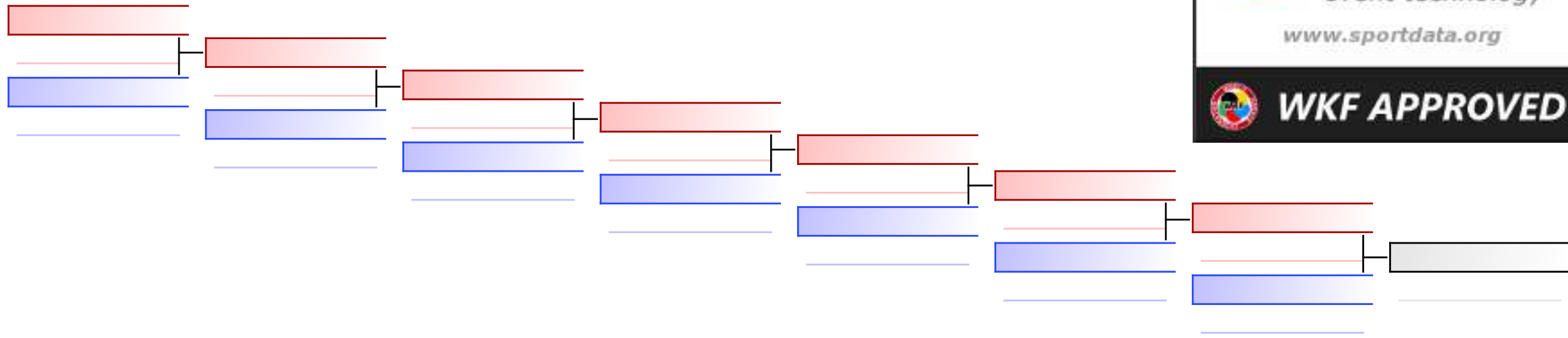

## TROSTRUNDE: (1)

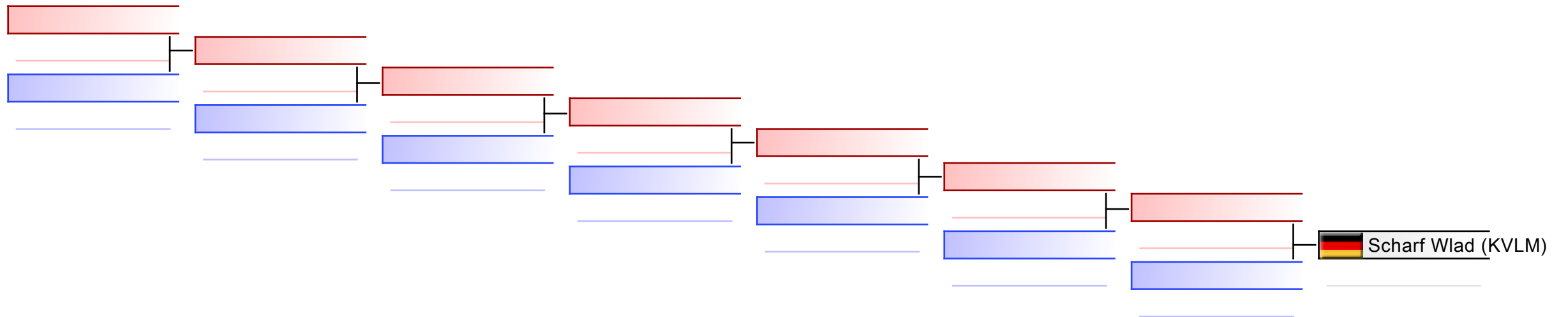

|           |  |  |  |  |  |  |  |
|-----------|--|--|--|--|--|--|--|
| Referees: |  |  |  |  |  |  |  |
|-----------|--|--|--|--|--|--|--|



Offene Landesmeisterschaft Hessen  
und Rheinland - Pfalz 2024 - 2024-02-03

Offizielle Ergebnisliste

| U21 Kumite Herren -84/+84kg |                    |                              |   |               |
|-----------------------------|--------------------|------------------------------|---|---------------|
| 1                           | EUL JAN            | TEAM FIGHTCLUB<br>WESTERWALD |  | GER - GERMANY |
| 2                           | SCHÄFER TIMO MARIA | TEAM FIGHTCLUB<br>WESTERWALD |  | GER - GERMANY |
| 3                           | SCHARF WLAD        | KV LIMBURG                   |  | GER - GERMANY |



Offene Landesmeisterschaft Hessen  
und Rheinland - Pfalz 2024 - 2024-02-03

Offizielle Ergebnisliste

| Jugend Kata Jungen |                    |  |  |               |  |
|--------------------|--------------------|--|--|---------------|--|
| 1                  | STEVERDING MICHELE | KARATE ZANSHIN BERGISCH GLADBACH E.V.    |  | GER - GERMANY |  |
| 2                  | SCHÖNMEIER MICHAEL | ZANSHIN GRÜN-WEISS FULDA                 |  | GER - GERMANY |  |
| 3                  | ELKAIEM MOHAMED    | BLACK LION SHOTOKAN KARATE KÖLN E.V.     |  | GER - GERMANY |  |
| 3                  | BIER PHILIP        | TURNVEREIN HOLZ 02 E.V.                  |  | GER - GERMANY |  |
| 5                  | WALZER ANTON       | KARATE-SCHULE DOKAN                      |  | GER - GERMANY |  |
| 5                  | MÜNCH FABIO        | SHOTOKAN RYU KARATE DO AKADEMIE RÜLZHEIM |  | GER - GERMANY |  |
| 7                  | JAHN LEON NOEL     | IGS BUDOKAN KAISERSLAUTERN               |  | GER - GERMANY |  |

| Jugend Kata Mädchen |                        |  |  |               |  |
|---------------------|------------------------|--|--|---------------|--|
| 1                   | BAGHDJIAN DANA         | SC JUDOKAN E.V.                          |  | GER - GERMANY |  |
| 2                   | STROH VENERA           | GOJU-RYU KARATEVEREIN SCHIFFERSTADT E.V. |  | GER - GERMANY |  |
| 3                   | DEMIRTAS MOMOKA        | SC JUDOKAN E.V.                          |  | GER - GERMANY |  |
| 3                   | ISKANDARYAN ANNE-MARIE | 1. SHOTOKAN KARATE CLUB FRANKENTHAL E.V. |  | GER - GERMANY |  |
| 5                   | SANDER SUVI-LINA       | KARATE-SCHULE DOKAN                      |  | GER - GERMANY |  |
| 5                   | BIEDEMANN HANNAH       | KARATE DOJO OKI BAYERN                   |  | GER - GERMANY |  |

| Jugend Kumite Jungen +70 kg |                   |                           |  |               |  |
|-----------------------------|-------------------|---------------------------|--|---------------|--|
| 1                           | AMBROSIOUS ELIAS  | KARATE CLUB WITTLICH      |  | GER - GERMANY |  |
| 2                           | AY MIRHAT         | KARATE MUTTERSTADT        |  | GER - GERMANY |  |
| 3                           | BREISCH SEBASTIAN | KARATE MUTTERSTADT        |  | GER - GERMANY |  |
| 3                           | GRÜNER MIKA       | TEIKYO KARATE TEAM E.V.   |  | GER - GERMANY |  |
| 5                           | HUSSEIN FARAJ     | KARATE-VEREIN LANGEN E.V. |  | GER - GERMANY |  |

| Jugend Kumite Jungen -52 kg |                   |                                     |  |               |  |
|-----------------------------|-------------------|-------------------------------------|--|---------------|--|
| 1                           | TSCHUMAROW ANDREJ | TEAM FIGHTCLUB WESTERWALD           |  | GER - GERMANY |  |
| 2                           | CHNYKIN KIRIL     | SV HERKULES 01 KASSEL E.V.          |  | GER - GERMANY |  |
| 3                           | RUHMANN MAX       | SAARLÄNDISCHER KARATE- VERBAND E.V. |  | GER - GERMANY |  |
| 3                           | BECKER YANNIK     | KARATE TEAM KSC PUDERBACH           |  | GER - GERMANY |  |
| 5                           | SWIDERSKY BEN     | KARATE TEAM KSC PUDERBACH           |  | GER - GERMANY |  |





Offene Landesmeisterschaft Hessen  
und Rheinland - Pfalz 2024 - 2024-02-03

Offizielle Ergebnisliste

|   |                  |                               |  |               |  |
|---|------------------|-------------------------------|--|---------------|--|
| 5 | MEZHLUMOVA DAVID | SV HERKULES 01<br>KASSEL E.V. |  | GER - GERMANY |  |
|---|------------------|-------------------------------|--|---------------|--|

Jugend Kumite Jungen -57 kg

|   |               |                               |  |               |  |
|---|---------------|-------------------------------|--|---------------|--|
| 1 | BECKER FINLEY | KARATE TEAM KSC<br>PUDERBACH  |  | GER - GERMANY |  |
| 2 | HACKEL FYNN   | KARATE<br>MUTTERSTADT         |  | GER - GERMANY |  |
| 3 | STACH DANIEL  | SV HERKULES 01<br>KASSEL E.V. |  | GER - GERMANY |  |

Jugend Kumite Jungen -63 kg

|   |                 |                              |  |               |  |
|---|-----------------|------------------------------|--|---------------|--|
| 1 | NIEDERELZ TIM   | SEN5 KARATE<br>VEREIN E.V.   |  | GER - GERMANY |  |
| 2 | SPOHR TOM ANGUS | TEAM FIGHTCLUB<br>WESTERWALD |  | GER - GERMANY |  |
| 3 | SERBAN RARES    | KARATE-DOJO<br>KELKHEIM E.V. |  | GER - GERMANY |  |
| 3 | KURZ PHIL       | TEAM FIGHTCLUB<br>WESTERWALD |  | GER - GERMANY |  |

Jugend Kumite Mädchen +61 kg

|   |                     |  |  |               |  |
|---|---------------------|--|--|---------------|--|
| 1 | SCHINDLER MILEY     | SEN5 KARATE<br>VEREIN E.V.                     |  | GER - GERMANY |  |
| 2 | WEISSENMEYER EMILIA | GOJU-RYU<br>KARATEVEREIN<br>SCHIFFERSTADT E.V. |  | GER - GERMANY |  |
| 3 | THEOBALD MIA        | SAARLÄNDISCHER<br>KARATE- VERBAND<br>E.V.      |  | GER - GERMANY |  |

Jugend Kumite Mädchen -47 kg

|   |                   |  |  |               |  |
|---|-------------------|--|--|---------------|--|
| 1 | STAUDT SAMIRA     | TEAM FIGHTCLUB<br>WESTERWALD                   |  | GER - GERMANY |  |
| 2 | BRETTNACHER JULIE | TEAM FIGHTCLUB<br>WESTERWALD                   |  | GER - GERMANY |  |
| 3 | WIENBECK RANI     | SFL KARATE<br>BREMERHAVEN                      |  | GER - GERMANY |  |
| 3 | GIORDANO ALICE    | GOJU-RYU<br>KARATEVEREIN<br>SCHIFFERSTADT E.V. |  | GER - GERMANY |  |

Jugend Kumite Mädchen -54 kg

|   |                  |  |  |               |  |
|---|------------------|--|--|---------------|--|
| 1 | HOHEISEL PAULA   | TEAM FIGHTCLUB<br>WESTERWALD                   |  | GER - GERMANY |  |
| 2 | DAMM LISA-MARIA  | SV HERKULES 01<br>KASSEL E.V.                  |  | GER - GERMANY |  |
| 3 | STROH VENERA     | GOJU-RYU<br>KARATEVEREIN<br>SCHIFFERSTADT E.V. |  | GER - GERMANY |  |
| 3 | IGL MIA          | GOJU-RYU<br>KARATEVEREIN<br>SCHIFFERSTADT E.V. |  | GER - GERMANY |  |
| 5 | MELNYKOVA EMILIA | KARATE<br>MUTTERSTADT                          |  | GER - GERMANY |  |

Jugend Kumite Mädchen -61 kg

|   |                 |                            |  |               |  |
|---|-----------------|----------------------------|--|---------------|--|
| 1 | GIEGLING MILENA | SEN5 KARATE<br>VEREIN E.V. |  | GER - GERMANY |  |
|---|-----------------|----------------------------|--|---------------|--|







Offene Landesmeisterschaft Hessen  
und Rheinland - Pfalz 2024 - 2024-02-03

Offizielle Ergebnisliste

|   |                       |                              |  |               |  |
|---|-----------------------|------------------------------|--|---------------|--|
| 2 | PHOK DAVARY           | KARATE-DOJO LICH<br>E.V.     |  | GER - GERMANY |  |
| 3 | CAMUFFO DEBORA        | RHEIN-NECKAR<br>KNIGHTS      |  | GER - GERMANY |  |
| 3 | CHALCOU-FREIER MAHINA | ZANSHIN GRÜN-<br>WEISS FULDA |  | GER - GERMANY |  |
| 5 | ABBAS FIZA            | RHEIN-NECKAR<br>KNIGHTS      |  | GER - GERMANY |  |

Jugend Kumite Team Jungen

|   |   |  |  |               |  |
|---|---|--|--|---------------|--|
| 1 | TEAM FIGHTCLUB<br>WESTERWALD 3<br>- TSCHUMAROW ANDREJ<br>- SPOHR TOM_ANGUS<br>- KURZ PHIL                         | TEAM FIGHTCLUB<br>WESTERWALD                   |  | GER - GERMANY |  |
| 2 | KARATE TEAM KSC<br>PUDERBACH<br>- SWIDERSKY BEN<br>- BECKER YANNIK<br>- BECKER FINLEY                             | KARATE TEAM KSC<br>PUDERBACH                   |  | GER - GERMANY |  |
| 3 | KG SEN5/RHEIN NECKAR<br>KNIGHTS<br>- GUIDOUCHE YACOB<br>- LENK CHRISTIAN<br>- NIEDERELZ TIM<br>- UEBERFELD FABIAN | SEN5 KARATE<br>VEREIN E.V.                     |  | GER - GERMANY |  |
| 3 | KG FRANKENTHAL /<br>MUTTERSTADT<br>- AY MIRHAT<br>- BREISCH SEBASTIAN<br>- HACKEL FYNN<br>- LUBENETS DANIEL       | 1. SHOTOKAN<br>KARATE CLUB<br>FRANKENTHAL E.V. |  | GER - GERMANY |  |

Jugend Kumite Team Mädchen

|   |  |  |  |               |  |
|---|--|--|--|---------------|--|
| 1 | KG SEN5/KD LICH<br>- GIEGLING MILENA<br>- PHOK DAVARY<br>- SCHINDLER MILEY   | SEN5 KARATE<br>VEREIN E.V.                     |  | GER - GERMANY |  |
| 2 | TEAM FIGHTCLUB<br>WESTERWALD 1<br>- BRETTNACHER JULIE<br>- STAUDT SAMIRA<br>- RAUSCH LISA<br>- HOHEISEL PAULA      | TEAM FIGHTCLUB<br>WESTERWALD                   |  | GER - GERMANY |  |
| 3 | GOJU-RYU SCHIFFERSTADT<br>U16 WEIBLICH<br>- STROH VENERA<br>- IGL MIA<br>- GIORDANO ALICE<br>- WEISSENMEYER EMILIA | GOJU-RYU<br>KARATEVEREIN<br>SCHIFFERSTADT E.V. |  | GER - GERMANY |  |

Junioren Kata Jungen

|   |                        |                                       |  |               |  |
|---|------------------------|---------------------------------------|--|---------------|--|
| 1 | BECKER SEBASTIAN KAWIN | IGS BUDOKAN<br>KAISERSLAUTERN         |  | GER - GERMANY |  |
| 2 | KOCH ALEXANDER         | IGS BUDOKAN<br>KAISERSLAUTERN         |  | GER - GERMANY |  |
| 3 | SCHWARZ ELIAS ERWAN    | KARATE DOJO MAINZ<br>BRETZENHEIM E.V. |  | GER - GERMANY |  |
| 3 | HARTMANN JÖRN          | KARATE CLUB<br>SPEYER E.V.            |  | GER - GERMANY |  |





Offene Landesmeisterschaft Hessen  
und Rheinland - Pfalz 2024 - 2024-02-03

Offizielle Ergebnisliste

|   |               |                          |  |               |  |
|---|---------------|--------------------------|--|---------------|--|
| 5 | SPIES MAARTEN | TSG 1885 NEU<br>ISENBURG |  | GER - GERMANY |  |
|---|---------------|--------------------------|--|---------------|--|

**Junioren Kata Mädchen**

|   |                       |                                    |  |               |  |
|---|-----------------------|------------------------------------|--|---------------|--|
| 1 | POH NADINE SOPHIE     | IGS BUDOKAN<br>KAISERSLAUTERN      |  | GER - GERMANY |  |
| 2 | NETHE SONJA TRUC XUAN | SHOTOKAN KARATE<br>DOJO SPIRA E.V. |  | GER - GERMANY |  |
| 3 | JÜRGENS MELINA SAMIRA | KARATE-VEREIN<br>LANGEN E.V.       |  | GER - GERMANY |  |
| 3 | ÖZER CENET            | SC JUDOKAN E.V.                    |  | GER - GERMANY |  |

**Junioren Kumite Jungen +76 kg**

|   |                    |                               |  |               |  |
|---|--------------------|-------------------------------|--|---------------|--|
| 1 | KURTANOVIC ARMIN   | KARATE DOJO<br>DIETZENBACH    |  | GER - GERMANY |  |
| 2 | GLOWNIEWSKI JEREMY | KARATE<br>MUTTERSTADT         |  | GER - GERMANY |  |
| 3 | GUMPELSTETTER TIMO | SV HERKULES 01<br>KASSEL E.V. |  | GER - GERMANY |  |
| 3 | RIDIGER ERIC       | SV HERKULES 01<br>KASSEL E.V. |  | GER - GERMANY |  |

**Junioren Kumite Jungen -55 kg**

|   |                |  |  |               |  |
|---|----------------|--|--|---------------|--|
| 1 | STARJACKI JONA | SV UNTERROT                                    |  | GER - GERMANY |  |
| 2 | BÖHM LOUIS     | GOJU-RYU<br>KARATEVEREIN<br>SCHIFFERSTADT E.V. |  | GER - GERMANY |  |

**Junioren Kumite Jungen -61 kg**

|   |               |   |  |               |  |
|---|---------------|---|--|---------------|--|
| 1 | BRUNO GABRIEL | SAARLÄNDISCHER<br>KARATE- VERBAND<br>E.V. |  | GER - GERMANY |  |
| 2 | KNAUS DEVIN   | TEIKYO KARATE<br>TEAM E.V.                |  | GER - GERMANY |  |

**Junioren Kumite Jungen -68 kg**

|   |                        |  |  |               |  |
|---|------------------------|--|--|---------------|--|
| 1 | RAISWICH ROMAN         | SV HERKULES 01<br>KASSEL E.V.                  |  | GER - GERMANY |  |
| 2 | RURIS ADRIAN           | SEN5 KARATE<br>VEREIN E.V.                     |  | GER - GERMANY |  |
| 3 | BECKER MAURICE         | KARATE SPORT<br>VEREIN WIRGES E.V.             |  | GER - GERMANY |  |
| 3 | HORN YANN              | GOJU-RYU<br>KARATEVEREIN<br>SCHIFFERSTADT E.V. |  | GER - GERMANY |  |
| 5 | MLINARITSCH ALEXANDER  | KV LIMBURG                                     |  | GER - GERMANY |  |
| 5 | GÖLLINGER JULIEN-FELIX | KARATE<br>MUTTERSTADT                          |  | GER - GERMANY |  |

**Junioren Kumite Jungen -76 kg**

|   |                    |                                    |  |               |  |
|---|--------------------|------------------------------------|--|---------------|--|
| 1 | TAMANG COSIMO      | TEAM FIGHTCLUB<br>WESTERWALD       |  | GER - GERMANY |  |
| 2 | CLAUS BASTIAN      | KARATE<br>MUTTERSTADT              |  | GER - GERMANY |  |
| 3 | BECKER MAXIMILIAN  | KARATE SPORT<br>VEREIN WIRGES E.V. |  | GER - GERMANY |  |
| 3 | ELENBERG ALEXANDER | SV HERKULES 01<br>KASSEL E.V.      |  | GER - GERMANY |  |





Offene Landesmeisterschaft Hessen  
und Rheinland - Pfalz 2024 - 2024-02-03

Offizielle Ergebnisliste

| Junioren Kumite Mädchen +66 kg |                |                               |  |               |
|--------------------------------|----------------|-------------------------------|--|---------------|
| 1                              | PALAZI XENIA   | SC JUDOKAN E.V.               |  | GER - GERMANY |
| 2                              | RATH ANASTASIA | SV HERKULES 01<br>KASSEL E.V. |  | GER - GERMANY |

| Junioren Kumite Mädchen -66/-48 kg |                     |   |  |               |
|------------------------------------|---------------------|---|--|---------------|
| 1                                  | HERING ALIA         | TEAM FIGHTCLUB<br>WESTERWALD              |  | GER - GERMANY |
| 2                                  | JANOSCHECK CARLOTTA | SAARLÄNDISCHER<br>KARATE- VERBAND<br>E.V. |  | GER - GERMANY |

| Junioren Kumite Team Jungen |   |                                    |  |               |
|-----------------------------|---|------------------------------------|--|---------------|
| 1                           | SV HERKULES 01 KASSEL E.V.<br>- ELENBERG ALEXANDER<br>- GUMPELSTETTER TIMO<br>- RAISWICH ROMAN<br>- RATH KONSTANTIN<br>- RIDIGER ERIC | SV HERKULES 01<br>KASSEL E.V.      |  | GER - GERMANY |
| 2                           | KARATE MUTTERSTADT<br>- CLAUS BASTIAN<br>- GLOWNIEWSKI JEREMY<br>- GÖLLINGER JULIEN   | KARATE<br>MUTTERSTADT              |  | GER - GERMANY |
| 3                           | KARATE SPORT VEREIN<br>WIRGES E.V.<br>- BECKER MAURICE<br>- BECKER MAXIMILIAN<br>- TAMANG COSIMO                                      | KARATE SPORT<br>VEREIN WIRGES E.V. |  | GER - GERMANY |

| Kata Masterklasse Damen Ü30/Ü35 |                   |                             |  |               |
|---------------------------------|-------------------|-----------------------------|--|---------------|
| 1                               | AGTE SARAH        | SKO WISMAR E.V.             |  | GER - GERMANY |
| 2                               | BRACH LIVIA       | KARATE ILVESHEIM            |  | GER - GERMANY |
| 3                               | ZECHLIN SLADANA   | KARATE CLUB<br>BUSHIDO BONN |  | GER - GERMANY |
| 3                               | WALLUSCH PATRICIA | SC JUDOKAN E.V.             |  | GER - GERMANY |

| Kata Masterklasse Damen Ü45 |                 |   |  |               |
|-----------------------------|-----------------|---|--|---------------|
| 1                           | KLAAS MANUELA   | KARATE DOJO<br>MAYEN-MENDIG                 |  | GER - GERMANY |
| 2                           | STEVERDING SARA | KARATE ZANSHIN<br>BERGISCH<br>GLADBACH E.V. |  | GER - GERMANY |
| 3                           | DURDEVIC JASNA  | SV UNSU KARATE<br>MÖMLINGEN E.V.            |  | GER - GERMANY |
| 3                           | MAIER BERENIKE  | KARATE CLUB<br>BUSHIDO BONN                 |  | GER - GERMANY |
| 5                           | ROTH NADJA      | TV. ST.WENDEL-ABT<br>KARATE                 |  | GER - GERMANY |

| Kata Masterklasse Damen Ü55 |                       |                             |  |               |
|-----------------------------|-----------------------|-----------------------------|--|---------------|
| 1                           | LANG MONIKA           | SC JUDOKAN E.V.             |  | GER - GERMANY |
| 2                           | GERKE-KÖRTING MANUELA | KARATE CLUB<br>BUSHIDO BONN |  | GER - GERMANY |
| 3                           | HAMAMI JOHEINA        | SC JUDOKAN E.V.             |  | GER - GERMANY |





Offene Landesmeisterschaft Hessen  
und Rheinland - Pfalz 2024 - 2024-02-03

Offizielle Ergebnisliste

| Kata Masterklasse Herren Ü30/Ü35 |                |                          |  |               |
|----------------------------------|----------------|--------------------------|--|---------------|
| 1                                | PRIVITERA NICO | KARATE ILVESHEIM         |  | GER - GERMANY |
| 2                                | BRACKMANN ULF  | PSV MANNHEIM E.V.        |  | GER - GERMANY |
| 3                                | KRAMER JOCHEN  | KARATE CLUB BUSHIDO BONN |  | GER - GERMANY |

| Kata Masterklasse Herren Ü45 |                  |  |  |               |
|------------------------------|------------------|--|--|---------------|
| 1                            | KLÖDITZ MARKUS   | SHOTOKAN RYU KARATE DO AKADEMIE RÜLZHEIM |  | GER - GERMANY |
| 2                            | BOEHM THILO      | BUDOCLUB RHEIN NECKAR E.V.               |  | GER - GERMANY |
| 3                            | HABERMEHL THOMAS | PSV MANNHEIM                             |  | GER - GERMANY |
| 3                            | TRZECIAK MICHAEL | KV ROSBACH                               |  | GER - GERMANY |
| 5                            | SPITZMÜLLER RALF | STUTTGART DOJOGEMEINSCHAFT               |  | GER - GERMANY |
| 5                            | KRAUS SEBASTIAN  | PSV MANNHEIM E.V.                        |  | GER - GERMANY |

| Kata Masterklasse Herren Ü55 |                     |                                   |  |               |
|------------------------------|---------------------|-----------------------------------|--|---------------|
| 1                            | WILHELM RAINER      | KARATE-DOJO FISCHBACH             |  | GER - GERMANY |
| 2                            | MÜLLER UWE          | KARATE CLUB WITTLICH              |  | GER - GERMANY |
| 3                            | SAILER TORSTEN      | PSV LUDWIGSHAFEN GRÜN WEISS       |  | GER - GERMANY |
| 3                            | MILTENBURGER THOMAS | KARATE DOJO MAINZ BRETZENHEIM E.V |  | GER - GERMANY |
| 5                            | BÖHM THOMAS         | KARATE-DOJO LICH E.V.             |  | GER - GERMANY |
| 5                            | OCHS WILFRIED       | POLIZEI SPORTVEREIN MAINZ E.V.    |  | GER - GERMANY |
| 7                            | KIENLE JÜRGEN       | POLIZEI SPORTVEREIN MAINZ E.V.    |  | GER - GERMANY |
| 7                            | STEFFES ROLAND      | KARATE CLUB WITTLICH              |  | GER - GERMANY |

| Kata Masterklasse Herren Ü65 |                   |  |  |               |
|------------------------------|-------------------|--|--|---------------|
| 1                            | BLANK LOUIS       | SC JUDOKAN E.V.                          |  | GER - GERMANY |
| 2                            | BIRLI JOSEF       | SPORTFREUNDE AFFATRA E.V.                |  | GER - GERMANY |
| 3                            | ADAM WOLFGANG     | SHOTOKAN RYU KARATE DO AKADEMIE RÜLZHEIM |  | GER - GERMANY |
| 3                            | MITTENZWEY RAINER | STUTTGART DOJOGEMEINSCHAFT               |  | GER - GERMANY |
| 5                            | SACK KLAUS-DIETER | POLIZEI SPORTVEREIN MAINZ E.V.           |  | GER - GERMANY |
| 5                            | PETZEL NORBERT    | SC JUDOKAN E.V.                          |  | GER - GERMANY |





Offene Landesmeisterschaft Hessen  
und Rheinland - Pfalz 2024 - 2024-02-03

Offizielle Ergebnisliste

| Kumite Masterklasse Damen |                |  |  |               |
|---------------------------|----------------|--|--|---------------|
| 1                         | HOLCZER STELLA | GOJU-RYU<br>KARATEVEREIN<br>SCHIFFERSTADT E.V. |  | GER - GERMANY |
| 2                         | HAMAMI JOHEINA | SC JUDOKAN E.V.                                |  | GER - GERMANY |

| Kumite Masterklasse Herren Ü35 +80 kg |                   |  |  |               |
|---------------------------------------|-------------------|--|--|---------------|
| 1                                     | ECK BENJAMIN      | KV LIMBURG                                       |  | GER - GERMANY |
| 2                                     | BOGER PATRICK     | TEAM FIGHTCLUB<br>WESTERWALD                     |  | GER - GERMANY |
| 3                                     | ULLRICH THOMAS    | SV DARMSTADT 98                                  |  | GER - GERMANY |
| 3                                     | KRÄMER JOCHEN     | KARATE CLUB<br>BUSHIDO BONN                      |  | GER - GERMANY |
| 5                                     | NDAGIJIMANA ABDOU | POLIZEISPORTVEREIN<br>GRÜN WEISS<br>KOBLENZ E.V. |  | GER - GERMANY |

| Kumite Masterklasse Herren Ü35 -80 kg |                 |  |  |               |
|---------------------------------------|-----------------|--|--|---------------|
| 1                                     | SCHOPPEL MARTIN | GOJU-RYU<br>KARATEVEREIN<br>SCHIFFERSTADT E.V. |  | GER - GERMANY |
| 2                                     | STAHL STEFFEN   | KV LIMBURG                                     |  | GER - GERMANY |
| 3                                     | DRESSLER KURT   | TEAM FIGHTCLUB<br>WESTERWALD                   |  | GER - GERMANY |
| 3                                     | ROST BENJAMIN   | SEN5 KARATE<br>VEREIN E.V.                     |  | GER - GERMANY |

| Kumite Masterklasse Herren Ü45 +80 kg |                  |                            |  |               |
|---------------------------------------|------------------|----------------------------|--|---------------|
| 1                                     | ALHUSSEIN ANAS   | SEN5 KARATE<br>VEREIN E.V. |  | GER - GERMANY |
| 2                                     | TRZECIAK MICHAEL | KV ROSBACH                 |  | GER - GERMANY |

| Kumite Masterklasse Herren Ü45 -80 kg |                |                              |  |               |
|---------------------------------------|----------------|------------------------------|--|---------------|
| 1                                     | MATHEIS MARTIN | SEN5 KARATE<br>VEREIN E.V.   |  | GER - GERMANY |
| 2                                     | JÄGER MARKUS   | TEAM FIGHTCLUB<br>WESTERWALD |  | GER - GERMANY |

| Kumite Masterklasse Herren Ü55 +80 kg |                 |                              |  |               |
|---------------------------------------|-----------------|------------------------------|--|---------------|
| 1                                     | KOHLER THORSTEN | KARATE - DOJO<br>HAUSTADT EV |  | GER - GERMANY |
| 2                                     | STEFFES ROLAND  | KARATE CLUB<br>WITTLICH      |  | GER - GERMANY |

| Kumite Masterklasse Herren Ü55/Ü65 -80kg |                      |   |  |               |
|--|----------------------|---|--|---------------|
| 1  | BLANK LOUIS          | SC JUDOKAN E.V.                                 |  | GER - GERMANY |
| 2  | BELLINGERI STEFANO   | SC JUDOKAN E.V.                                 |  | GER - GERMANY |
| 3  | STURZENHECKER THOMAS | 1. BONN-BUEELER<br>SHOTOKAN KARATE<br>DOJO E.V. |  | GER - GERMANY |
| 3  | BLATT MARIO          | TEAM FIGHTCLUB<br>WESTERWALD                    |  | GER - GERMANY |

| Kumite Team Herren Leistungsklasse/U21 |                            |                               |  |               |
|--|----------------------------|-------------------------------|--|---------------|
| 1                                      | SV HERKULES 01 KASSEL E.V. | SV HERKULES 01<br>KASSEL E.V. |  | GER - GERMANY |





Offene Landesmeisterschaft Hessen  
und Rheinland - Pfalz 2024 - 2024-02-03

Offizielle Ergebnisliste

|   |   |   |  |               |
|---|---|---|--|---------------|
|   | - BIER MARVIN<br>- HARISOW MAXIM<br>- SHEPELEV MARCEL<br>- TAKZIMA AYMANE   |   |  |               |
| 2 | SAARLÄNDISCHER KARATE-<br>VERBAND E.V.<br>- MÜLLER ELIAS<br>- MAWARDI AHMAD<br>- ALKATEP AHMAD<br>- AZIMI MASSIHULLAH | SAARLÄNDISCHER<br>KARATE- VERBAND<br>E.V. |  | GER - GERMANY |

Leistungsklasse Kata Damen

|   |                       |   |  |               |
|---|-----------------------|---|--|---------------|
| 1 | FAUL ANNIKA           | IGS BUDOKAN<br>KAISERSLAUTERN             |  | GER - GERMANY |
| 2 | GRIESSEL CAROLINA     | 1. SHOTOKAN<br>KARATE VEREIN<br>SPEYER    |  | GER - GERMANY |
| 3 | AGTE SARAH            | SKO WISMAR E.V.                           |  | GER - GERMANY |
| 3 | KURZ RONYA            | SAARLÄNDISCHER<br>KARATE- VERBAND<br>E.V. |  | GER - GERMANY |
| 5 | SCHWALBACH NINA       | KARATE DOJO MAINZ<br>BRETZENHEIM E.V      |  | GER - GERMANY |
| 5 | DIELMANN JESSICA      | SC JUDOKAN E.V.                           |  | GER - GERMANY |
| 7 | OHNESORGE REBECCA     | ZANSHIN GRÜN-<br>WEISS FULDA              |  | GER - GERMANY |
| 7 | FELLINGER ANNA SOPHIE | KARATE DOJO MAINZ<br>BRETZENHEIM E.V      |  | GER - GERMANY |
| 9 | KOCH JACQUELINE       | SV UNTERROT                               |  | GER - GERMANY |
| 9 | FREDRICH JULIA        | ZANSHIN GRÜN-<br>WEISS FULDA              |  | GER - GERMANY |

Leistungsklasse Kata Herren

|   |                          |                                    |  |               |
|---|--------------------------|------------------------------------|--|---------------|
| 1 | HADIZADEH JULIAN FABRICE | IGS BUDOKAN<br>KAISERSLAUTERN      |  | GER - GERMANY |
| 2 | KHEIRI-AHVAZI NIMA       | SC JUDOKAN E.V.                    |  | GER - GERMANY |
| 3 | HÖFT HANNES              | BUDOCLUB RHEIN-<br>NECKAR E.V.     |  | GER - GERMANY |
| 3 | HEINE MORITZ             | SC JUDOKAN E.V.                    |  | GER - GERMANY |
| 5 | THIEROLF JULIAN          | SV UNSU KARATE<br>MÖMLINGEN E.V.   |  | GER - GERMANY |
| 5 | GUSTAVUS MARIUS          | SC JUDOKAN E.V.                    |  | GER - GERMANY |
| 7 | PREISENDÖRFER KIRAN      | KENSHO<br>NEUKIRCHEN-VLUYN<br>E.V. |  | GER - GERMANY |

Leistungsklasse Kata Team männlich

|   |   |   |  |               |
|---|---|---|--|---------------|
| 1 | KATATEAM PSV MAINZ<br>- SACK KLAUS-DIETER<br>- OCHS WILFRIED<br>- KIENLE JÜRGEN | POLIZEI<br>SPORTVEREIN<br>MAINZ E.V.              |  | GER - GERMANY |
| 2 | SKA RÜLZHEIM 1<br>- KÜSTER NIKLAS<br>- MÜNCH FABIO<br>- WANKMÜLLER JANNE-RIK    | SHOTOKAN<br>RYU KARATE<br>DO AKADEMIE<br>RÜLZHEIM |  | GER - GERMANY |





Offene Landesmeisterschaft Hessen  
und Rheinland - Pfalz 2024 - 2024-02-03

Offizielle Ergebnisliste

| Leistungsklasse Kata Team weiblich |   |                                      |  |               |
|------------------------------------|---|--------------------------------------|--|---------------|
| 1                                  | PSV MAINZ KATATEAM<br>- LEUCKEL MELANIE<br>- NOWICKI IRIS<br>- MACK KATHARINA                   | POLIZEI<br>SPORTVEREIN<br>MAINZ E.V. |  | GER - GERMANY |
| 2                                  | KG TEAM BUDOKAN KL/<br>EINTRACHT FFM<br>- FAUL ANNIKA<br>- NGUYEN CARINA<br>- POH NADINE_SOPHIE | IGS BUDOKAN<br>KAISERSLAUTERN        |  | GER - GERMANY |

| Leistungsklasse Kumite +68 kg weiblich |                 |   |  |               |
|--|-----------------|---|--|---------------|
| 1                                      | SCHERER JOHANNA | SAARLÄNDISCHER<br>KARATE- VERBAND<br>E.V. |  | GER - GERMANY |

| Leistungsklasse Kumite +84 kg männlich |                 |                               |  |               |
|--|-----------------|-------------------------------|--|---------------|
| 1                                      | SHEPELEV MARCEL | SV HERKULES 01<br>KASSEL E.V. |  | GER - GERMANY |
| 2                                      | ECK BENJAMIN    | KV LIMBURG                    |  | GER - GERMANY |
| 3                                      | OMIDI BEHZAD    | KARATE-DOJO<br>KELKHEIM E.V.  |  | GER - GERMANY |
| 3                                      | KRÄMER JOCHEN   | KARATE CLUB<br>BUSHIDO BONN   |  | GER - GERMANY |

| Leistungsklasse Kumite -50 kg weiblich |                  |                              |  |               |
|--|------------------|------------------------------|--|---------------|
| 1                                      | BRETTNACHER LARA | TEAM FIGHTCLUB<br>WESTERWALD |  | GER - GERMANY |
| 2                                      | REIS NELE        | KARATE CLUB<br>WITTLICH      |  | GER - GERMANY |

| Leistungsklasse Kumite -55 kg weiblich |                    |  |  |               |
|--|--------------------|--|--|---------------|
| 1                                      | HOLCZER STELLA     | GOJU-RYU<br>KARATEVEREIN<br>SCHIFFERSTADT E.V. |  | GER - GERMANY |
| 2                                      | HOFFMANN MAJA      | SAARLÄNDISCHER<br>KARATE- VERBAND<br>E.V.      |  | GER - GERMANY |
| 3                                      | OBST TARA JENNIFER | KARATE DOJO<br>DIETZENBACH                     |  | GER - GERMANY |
| 3                                      | HASIC MINELA       | ZANSHIN GRÜN-<br>WEISS FULDA                   |  | GER - GERMANY |

| Leistungsklasse Kumite -60 kg männlich |                      |  |  |               |
|--|----------------------|--|--|---------------|
| 1                                      | BLUMENAUER ALEC      | SEN5 KARATE<br>VEREIN E.V.                     |  | GER - GERMANY |
| 2                                      | EGERLAND MARVIN-LUCA | GOJU-RYU<br>KARATEVEREIN<br>SCHIFFERSTADT E.V. |  | GER - GERMANY |

| Leistungsklasse Kumite -61 kg weiblich |               |                              |  |               |
|--|---------------|------------------------------|--|---------------|
| 1                                      | WEILER MARIEL | KARATE TEAM KSC<br>PUDERBACH |  | GER - GERMANY |

| Leistungsklasse Kumite -67 kg männlich |                |                               |  |               |
|--|----------------|-------------------------------|--|---------------|
| 1                                      | TAKZIMA AYMANE | SV HERKULES 01<br>KASSEL E.V. |  | GER - GERMANY |







Offene Landesmeisterschaft Hessen  
und Rheinland - Pfalz 2024 - 2024-02-03

Offizielle Ergebnisliste

|   |   |                                |  |               |  |
|---|---|--------------------------------|--|---------------|--|
| 2 | THRAN MELVIN                            | TEAM FIGHTCLUB<br>WESTERWALD   |  | GER - GERMANY |  |
| 3 | AZIMI MASSIHULLA                        | BUDOCLUB RHEIN-<br>NECKAR E.V. |  | GER - GERMANY |  |
| 3 | QUADT LUKAS                             | TEIKYO KARATE<br>TEAM E.V.     |  | GER - GERMANY |  |
| 5 | CHUUTCHEN-CHUIGONE<br>EMERAN DE S-ROGER | KARATEVEREIN<br>FRIEDBERG      |  | GER - GERMANY |  |
| 5 | HELM MARIUS                             | KAMPFSPORT CLUB<br>HÜNFELD     |  | GER - GERMANY |  |

| Leistungsklasse Kumite -68 kg weiblich |                           |  |  |               |  |
|--|---------------------------|--|--|---------------|--|
| 1                                      | EIZADYARIAGHMIYOUNI PARIA | KARATEVEREIN<br>FRIEDBERG                      |  | GER - GERMANY |  |
| 2                                      | DJAPA SARA                | GOJU-RYU<br>KARATEVEREIN<br>SCHIFFERSTADT E.V. |  | GER - GERMANY |  |
| 3                                      | LANGER LETICIA            | KARATE DOJO<br>DIETZENBACH                     |  | GER - GERMANY |  |
| 3                                      | WOLZ ANNA                 | RHEIN-NECKAR<br>KNIGHTS                        |  | GER - GERMANY |  |

| Leistungsklasse Kumite -75 kg männlich |                     |  |  |               |  |
|--|---------------------|--|--|---------------|--|
| 1                                      | BIER MARVIN         | KARATE DOJO<br>DIETZENBACH                     |  | GER - GERMANY |  |
| 2                                      | ASLAN EMRE          | KV LIMBURG                                     |  | GER - GERMANY |  |
| 3                                      | SCHOPPEL MARTIN     | GOJU-RYU<br>KARATEVEREIN<br>SCHIFFERSTADT E.V. |  | GER - GERMANY |  |
| 3                                      | BEYERSDÖRFER PHILIP | TEIKYO KARATE<br>TEAM E.V.                     |  | GER - GERMANY |  |
| 5                                      | SCHMAUDER JULIUS    | KARATE-VEREIN<br>LANGEN E.V.                   |  | GER - GERMANY |  |

| Leistungsklasse Kumite -84 kg männlich |                    |                              |  |               |  |
|--|--------------------|------------------------------|--|---------------|--|
| 1                                      | SCHÄFER TIMO MARIA | TEAM FIGHTCLUB<br>WESTERWALD |  | GER - GERMANY |  |
| 2                                      | EUL JAN            | TEAM FIGHTCLUB<br>WESTERWALD |  | GER - GERMANY |  |
| 3                                      | LE MINH-THUONG     | ZANSHIN GRÜN-<br>WEISS FULDA |  | GER - GERMANY |  |
| 3                                      | SCHARF WLAD        | KV LIMBURG                   |  | GER - GERMANY |  |
| 5                                      | ULLRICH THOMAS     | SV DARMSTADT 98              |  | GER - GERMANY |  |

| Leistungsklasse Kumite Team weiblich |   |  |  |               |  |
|--------------------------------------|---|--|--|---------------|--|
| 1                                    | GOJU-RYU SCHIFFERSTADT LK<br>DAMEN<br>- HOLCZER STELLA<br>- WOLZ ANNA<br>- DJAPA SARA         | GOJU-RYU<br>KARATEVEREIN<br>SCHIFFERSTADT E.V. |  | GER - GERMANY |  |
| 2                                    | KARATE TEAM KSC<br>PUDERBACH<br>- WEILER MARIEL<br>- MUJEZINOVIC SAMIRA<br>- BRETTNACHER LARA | KARATE TEAM KSC<br>PUDERBACH                   |  | GER - GERMANY |  |
| 3                                    | KARATE DOJO DIETZENBACH   | KARATE DOJO<br>DIETZENBACH                     |  | GER - GERMANY |  |







Offene Landesmeisterschaft Hessen  
und Rheinland - Pfalz 2024 - 2024-02-03

Offizielle Ergebnisliste

|   |  |  |  |  |
|---|--|--|--|--|
| - KLAUTKE KRISTAMARIE<br>- LANGER LETICIA<br>- MIELKE NELE<br>- OBST TARA ,JENNIFER<br>- WORMS LARA |  |  |  |  |
|---|--|--|--|--|

**Masterklasse Kata Team mixed**

|   |   |                                      |  |               |  |
|---|---|--------------------------------------|--|---------------|--|
| 1 | KATATEAM PSV MAINZ<br>- SACK KLAUS-DIETER<br>- OCHS WILFRIED<br>- KIENLE JÜRGEN | POLIZEI<br>SPORTVEREIN<br>MAINZ E.V. |  | GER - GERMANY |  |
| 2 | PSV MAINZ KATATEAM<br>- LEUCKEL MELANIE<br>- NOWICKI IRIS<br>- MACK KATHARINA   | POLIZEI<br>SPORTVEREIN<br>MAINZ E.V. |  | GER - GERMANY |  |

**U21 Kata Damen**

|   |                  |  |  |               |  |
|---|------------------|--|--|---------------|--|
| 1 | HEBBEL PATRICIA  | SC JUDOKAN E.V.                        |  | GER - GERMANY |  |
| 2 | GRIESEL CAROLINA | 1. SHOTOKAN<br>KARATE VEREIN<br>SPEYER |  | GER - GERMANY |  |
| 3 | FAUL ANNIKA      | IGS BUDOKAN<br>KAISERSLAUTERN          |  | GER - GERMANY |  |
| 3 | DIELMANN JESSICA | SC JUDOKAN E.V.                        |  | GER - GERMANY |  |
| 5 | BOSSERDT VANESSA | KARATE DOJO<br>MAYEN-MENDIG            |  | GER - GERMANY |  |
| 7 | KRAWCZYK JULIA   | BUDOCLUB RHEIN-<br>NECKAR E.V.         |  | GER - GERMANY |  |

**U21 Kata Herren**

|   |                          |   |  |               |  |
|---|--------------------------|---|--|---------------|--|
| 1 | HADIZADEH JULIAN FABRICE | IGS BUDOKAN<br>KAISERSLAUTERN                     |  | GER - GERMANY |  |
| 2 | ZIZA RAYAN               | SHOTOKAN<br>RYU KARATE<br>DO AKADEMIE<br>RÜLZHEIM |  | GER - GERMANY |  |
| 3 | LIEDY JONAS-PASCAL       | SHOTOKAN KARATE<br>DOJO SPIRA E.V.                |  | GER - GERMANY |  |
| 3 | KHEIRI-AHVAZI NIMA       | SC JUDOKAN E.V.                                   |  | GER - GERMANY |  |
| 5 | HEUSER NICK              | KARATE CLUB<br>HATTERSHEIM                        |  | GER - GERMANY |  |

**U21 Kumite Damen -50 kg**

|   |                  |                              |  |               |  |
|---|------------------|------------------------------|--|---------------|--|
| 1 | BRETTNACHER LARA | TEAM FIGHTCLUB<br>WESTERWALD |  | GER - GERMANY |  |
| 2 | REIS NELE        | KARATE CLUB<br>WITTLICH      |  | GER - GERMANY |  |

**U21 Kumite Damen -55 kg**

|   |               |   |  |               |  |
|---|---------------|---|--|---------------|--|
| 1 | HOFFMANN MAJA | SAARLÄNDISCHER<br>KARATE- VERBAND<br>E.V. |  | GER - GERMANY |  |
| 2 | HASIC MINELA  | ZANSHIN GRÜN-<br>WEISS FULDA              |  | GER - GERMANY |  |
| 3 | SIKAVICA DORA | SC JUDOKAN E.V.                           |  | GER - GERMANY |  |





Offene Landesmeisterschaft Hessen  
und Rheinland - Pfalz 2024 - 2024-02-03

Offizielle Ergebnisliste

| U21 Kumite Damen -61 kg |               |                              |  |               |
|-------------------------|---------------|------------------------------|--|---------------|
| 1                       | WEILER MARIEL | KARATE TEAM KSC<br>PUDERBACH |  | GER - GERMANY |

| U21 Kumite Damen -68/+68kg |                           |   |  |               |
|----------------------------|---------------------------|---|--|---------------|
| 1                          | EIZADYARIAGHMIYOUNI PARIA | KARATEVEREIN<br>FRIEDBERG                 |  | GER - GERMANY |
| 2                          | SCHERER JOHANNA           | SAARLÄNDISCHER<br>KARATE- VERBAND<br>E.V. |  | GER - GERMANY |

| U21 Kumite Herren -60 kg |                      |  |  |               |
|--------------------------|----------------------|--|--|---------------|
| 1                        | BLUMENAUER ALEC      | SEN5 KARATE<br>VEREIN E.V.                     |  | GER - GERMANY |
| 2                        | EGERLAND MARVIN-LUCA | GOJU-RYU<br>KARATEVEREIN<br>SCHIFFERSTADT E.V. |  | GER - GERMANY |

| U21 Kumite Herren -67 kg |                        |   |  |               |
|--------------------------|------------------------|---|--|---------------|
| 1                        | THRAN MELVIN           | TEAM FIGHTCLUB<br>WESTERWALD              |  | GER - GERMANY |
| 2                        | QUADT LUKAS            | TEIKYO KARATE<br>TEAM E.V.                |  | GER - GERMANY |
| 3                        | POPA ALEXANDRU-GABRIEL | KARATE-DOJO<br>KELKHEIM E.V.              |  | GER - GERMANY |
| 3                        | ALKATEP AHMAD          | SAARLÄNDISCHER<br>KARATE- VERBAND<br>E.V. |  | GER - GERMANY |
| 5                        | HAMRODI JAN            | SC IDSTEIN                                |  | GER - GERMANY |

| U21 Kumite Herren -75 kg |                     |                              |  |               |
|--------------------------|---------------------|------------------------------|--|---------------|
| 1                        | BEYERSDÖRFER PHILIP | TEIKYO KARATE<br>TEAM E.V.   |  | GER - GERMANY |
| 2                        | SCHMAUDER JULIUS    | KARATE-VEREIN<br>LANGEN E.V. |  | GER - GERMANY |

| U21 Kumite Herren -84/+84kg |                    |                              |  |               |
|-----------------------------|--------------------|------------------------------|--|---------------|
| 1                           | EUL JAN            | TEAM FIGHTCLUB<br>WESTERWALD |  | GER - GERMANY |
| 2                           | SCHÄFER TIMO MARIA | TEAM FIGHTCLUB<br>WESTERWALD |  | GER - GERMANY |
| 3                           | SCHARF WLAD        | KV LIMBURG                   |  | GER - GERMANY |



Offene Landesmeisterschaft Hessen  
und Rheinland - Pfalz 2024 - 2024-02-03

Medaillenspiegel - Verein

| Rang | Verein   | 1. Platz | 2. Platz | 3. Platz |
|------|--|----------|----------|----------|
| 1    | TEAM FIGHTCLUB WESTERWALD, GER                 | 11       | 8        | 3        |
| 2    | SEN5 KARATE VEREIN E.V., GER                   | 8        | 1        | 2        |
| 3    | SC JUDOKAN E.V., GER                           | 6        | 3        | 8        |
| 4    | SV HERKULES 01 KASSEL E.V., GER                | 5        | 3        | 4        |
| 5    | IGS BUDOKAN KAISERSLAUTERN, GER                | 5        | 2        | 1        |
| 6    | GOJU-RYU KARATEVEREIN SCHIFFERSTADT E.V., GER  | 4        | 6        | 6        |
| 7    | SAARLÄNDISCHER KARATE- VERBAND E.V., GER       | 3        | 4        | 4        |
| 8    | KARATE TEAM KSC PUDERBACH, GER                 | 3        | 2        | 1        |
| 9    | POLIZEI SPORTVEREIN MAINZ E.V., GER            | 3        | 1        | 0        |
| 10   | KARATE DOJO DIETZENBACH, GER                   | 2        | 0        | 3        |
| 11   | KARATEVEREIN FRIEDBERG, GER                    | 2        | 0        | 0        |
| 12   | KARATE CLUB WITTLICH, GER                      | 1        | 4        | 0        |
| 13   | KV LIMBURG, GER                                | 1        | 3        | 2        |
| 14   | TEIKYO KARATE TEAM E.V., GER                   | 1        | 2        | 3        |
| 15   | SHOTOKAN RYU KARATE DO AKADEMIE RÜLZHEIM, GER  | 1        | 2        | 1        |
| 16   | KARATE ZANSHIN BERGISCH GLADBACH E.V., GER     | 1        | 1        | 0        |
|      | KARATE ILVESHEIM, GER                          | 1        | 1        | 0        |
| 18   | SKO WISMAR E.V., GER                           | 1        | 0        | 1        |
| 19   | KARATE DOJO MAYEN-MENDIG, GER                  | 1        | 0        | 0        |
|      | KARATE - DOJO HAUSTADT EV, GER                 | 1        | 0        | 0        |
|      | SV UNTERROT, GER                               | 1        | 0        | 0        |
|      | KARATE-DOJO FISCHBACH, GER                     | 1        | 0        | 0        |
| 23   | KARATE MUTTERSTADT, GER                        | 0        | 5        | 1        |
| 24   | ZANSHIN GRÜN-WEISS FULDA, GER                  | 0        | 2        | 3        |
| 25   | 1. SHOTOKAN KARATE VEREIN SPEYER, GER          | 0        | 2        | 0        |
| 26   | KARATE CLUB BUSHIDO BONN, GER                  | 0        | 1        | 5        |
| 27   | KARATE-VEREIN LANGEN E.V., GER                 | 0        | 1        | 1        |
|      | SHOTOKAN KARATE DOJO SPIRA E.V., GER           | 0        | 1        | 1        |
|      | KV ROSBACH, GER                                | 0        | 1        | 1        |
| 30   | PSV MANNHEIM E.V., GER                         | 0        | 1        | 0        |
|      | KARATE-DOJO LICH E.V., GER                     | 0        | 1        | 0        |
|      | SPORTFREUNDE AFFATRA E.V., GER                 | 0        | 1        | 0        |
|      | BUDOCLUB RHEIN NECKAR E.V., GER                | 0        | 1        | 0        |
| 34   | KARATE SPORT VEREIN WIRGES E.V., GER           | 0        | 0        | 3        |
|      | KARATE-DOJO KELKHEIM E.V., GER                 | 0        | 0        | 3        |
| 36   | KARATE DOJO MAINZ BRETZENHEIM E.V, GER         | 0        | 0        | 2        |
|      | BUDOCLUB RHEIN-NECKAR E.V., GER                | 0        | 0        | 2        |
|      | RHEIN-NECKAR KNIGHTS, GER                      | 0        | 0        | 2        |
|      | 1. SHOTOKAN KARATE CLUB FRANKENTHAL E.V., GER  | 0        | 0        | 2        |
| 40   | SFL KARATE BREMERHAVEN, GER                    | 0        | 0        | 1        |
|      | STUTTGART DOJOGEMEINSCHAFT, GER                | 0        | 0        | 1        |
|      | BLACK LION SHOTOKAN KARATE KÖLN E.V., GER      | 0        | 0        | 1        |
|      | SV DARMSTADT 98, GER                           | 0        | 0        | 1        |
|      | KARATE CLUB SPEYER E.V., GER                   | 0        | 0        | 1        |
|      | 1. BONN-BEUELER SHOTOKAN KARATE DOJO E.V., GER | 0        | 0        | 1        |
|      | PSV MANNHEIM, GER                              | 0        | 0        | 1        |
|      | TURNVEREIN HOLZ 02 E.V., GER                   | 0        | 0        | 1        |





Offene Landesmeisterschaft Hessen  
und Rheinland - Pfalz 2024 - 2024-02-03

Medaillenspiegel - Verein

|  |   |   |   |
|--|---|---|---|
|  SV UNSU KARATE MÖMLINGEN E.V., GER | 0 | 0 | 1 |
|  PSV LUDWIGSHAFEN GRÜN WEISS, GER   | 0 | 0 | 1 |

