



RESULTS BOOK

KARATE1 PREMIER LEAGUE - PARIS 2025

2025.01.24 - 2025.01.26

PIERRE DE COUBERTIN STADIUM, AVENUE GEORGE LAFONT
82, 75016 PARIS

FRANCE, FRA

TABLE OF CONTENTS

NUMBER OF ENTRIES	3
NUMBER OF ENTRIES BY CONTINENT	5
ENTRYLIST	8
STATISTICS	17
FEMALE KATA	18
FEMALE KUMITE -50 KG	30
FEMALE KUMITE -55 KG	42
FEMALE KUMITE -61 KG	54
FEMALE KUMITE -68 KG	66
FEMALE KUMITE 68+ KG	78
MALE KATA	90
MALE KUMITE -60 KG	102
MALE KUMITE -67 KG	114
MALE KUMITE -75 KG	126
MALE KUMITE -84 KG	138
MALE KUMITE 84+ KG	150
OFFICIAL RESULTS	162



Karate1 Premier League - Paris 2025

FRANCE

2025.01.24 - 2025.01.26

Pierre de Coubertin Stadium, Avenue George Lafont 82, 75016 Paris



NUMBER OF ENTRIES

#	Code	Country	Male Entries	Female Entries	Total Entries	Total Athletes
1		ALB ALBANIA	2	0	2	2
2		ALG ALGERIA	5	4	9	9
3		ARM ARMENIA	0	1	1	1
4		AUS AUSTRALIA	1	1	2	2
5		AUT AUSTRIA	0	2	2	2
6		AZE AZERBAIJAN	2	1	3	3
7		BEL BELGIUM	5	2	7	7
8		BIH BOSNIA AND HERZEGOVINA	1	3	4	4
9		BRA BRAZIL	1	1	2	2
10		BUL BULGARIA	0	2	2	2
11		CAN CANADA	0	4	4	4
12		CHI CHILE	4	4	8	8
13		TPE CHINESE TAIPEI	1	3	4	4
14		COL COLOMBIA	1	2	3	3
15		CRO CROATIA	3	5	8	8
16		CUR CURACAO	1	0	1	1
17		CYP CYPRUS	0	2	2	2
18		CZE CZECH REPUBLIC	1	1	2	2
19		ECU ECUADOR	1	1	2	2
20		EGY EGYPT	9	7	16	16
21		ESA EL SALVADOR	0	1	1	1
22		ENG ENGLAND	2	3	5	5
23		FIN FINLAND	2	0	2	2
24		FRA FRANCE	13	11	24	24
25		GEO GEORGIA	4	0	4	4
26		GER GERMANY	5	10	15	15
27		GRE GREECE	4	3	7	7
28		GUA GUATEMALA	1	0	1	1
29		HKG HONG KONG, CHINA	1	2	3	3
30		HUN HUNGARY	2	0	2	2
31		INA INDONESIA	0	2	2	2
32		IRL IRELAND	1	0	1	1
33		IRI ISLAMIC REPUBLIC OF IRAN	7	7	14	14
34		ITA ITALY	21	14	35	35
35		JPN JAPAN	15	13	28	28
36		JOR JORDAN	4	0	4	4
37		KAZ KAZAKHSTAN	4	5	9	9
38		KOS KOSOVO	0	2	2	2
39		KUW KUWAIT	3	0	3	3
40		LAT LATVIA	2	2	4	4
41		LBA LIBYA	1	0	1	1
42		LUX LUXEMBOURG	0	1	1	1
43		MAS MALAYSIA	0	1	1	1
44		MNE MONTENEGRO	2	0	2	2
45		MAR MOROCCO	2	4	6	6
46		NED NETHERLANDS	4	4	8	8



Karate1 Premier League - Paris 2025

FRANCE

2025.01.24 - 2025.01.26

Pierre de Coubertin Stadium, Avenue George Lafont 82, 75016 Paris



NUMBER OF ENTRIES

#	Code	Country	Male Entries	Female Entries	Total Entries	Total Athletes
47		MKD NORTH MACEDONIA	1	1	2	2
48		PER PERU	0	1	1	1
49		PHI PHILIPPINES	0	1	1	1
50		POL POLAND	1	4	5	5
51		POR PORTUGAL	4	6	10	10
52		PUR PUERTO RICO	0	1	1	1
53		ROU ROMANIA	3	0	3	3
54		KSA SAUDI ARABIA	1	0	1	1
55		SCO SCOTLAND	0	2	2	2
56		SEN SENEGAL	1	0	1	1
57		SRB SERBIA	1	0	1	1
58		SVK SLOVAKIA	3	1	4	4
59		SLO SLOVENIA	0	1	1	1
60		ESP SPAIN	0	7	7	7
61		SWE SWEDEN	1	3	4	4
62		SUI SWITZERLAND	1	5	6	6
63		THA THAILAND	1	0	1	1
64		TUN TUNISIA	2	3	5	5
65		TUR TURKIYE	13	12	25	25
66		TKM TURKMENISTAN	1	0	1	1
67		UKR UKRAINE	8	4	12	12
68		UAE UNITED ARAB EMIRATES	0	1	1	1
69		USA UNITED STATES	4	2	6	6
70		VEN VENEZUELA	2	3	5	5
Totals:			186	189	375	375



NUMBER OF ENTRIES BY COUNTRY AND CONTINENT



Karate1 Premier League - Paris 2025

As of 27 JAN 2025

Country Code	Continent / Country	Male Entries	Female Entries	Total Entries	Total Athletes
	AFRICA				
ALG	ALGERIA	5	4	9	9
EGY	EGYPT	9	7	16	16
LBA	LIBYA	1	0	1	1
MAR	MOROCCO	2	4	6	6
SEN	SENEGAL	1	0	1	1
TUN	TUNISIA	2	3	5	5
Total	AFRICA	6	20	38	38
	ASIA				
TPE	CHINESE TAIPEI	1	3	4	4
HKG	HONG KONG, CHINA	1	2	3	3
INA	INDONESIA	0	2	2	2
IRI	ISLAMIC REPUBLIC OF IRAN	7	7	14	14
JPN	JAPAN	15	13	28	28
JOR	JORDAN	4	0	4	4
KAZ	KAZAKHSTAN	4	5	9	9
KUW	KUWAIT	3	0	3	3
MAS	MALAYSIA	0	1	1	1
PHI	PHILIPPINES	0	1	1	1
KSA	SAUDI ARABIA	1	0	1	1
THA	THAILAND	1	0	1	1
TKM	TURKMENISTAN	1	0	1	1
UAE	UNITED ARAB EMIRATES	0	1	1	1
Total	ASIA	14	38	73	73
	EUROPE				
ALB	ALBANIA	2	0	2	2
ARM	ARMENIA	0	1	1	1
AUT	AUSTRIA	0	2	2	2
AZE	AZERBAIJAN	2	1	3	3
BEL	BELGIUM	5	2	7	7
BIH	BOSNIA AND HERZEGOVINA	1	3	4	4
BUL	BULGARIA	0	2	2	2
CRO	CROATIA	3	5	8	8
CYP	CYPRUS	0	2	2	2
CZE	CZECH REPUBLIC	1	1	2	2
ENG	ENGLAND	2	3	5	5
FIN	FINLAND	2	0	2	2
FRA	FRANCE	13	11	24	24



NUMBER OF ENTRIES BY COUNTRY AND CONTINENT



Karate1 Premier League - Paris 2025

As of 27 JAN 2025

Country Code	Continent / Country	Male Entries	Female Entries	Total Entries	Total Athletes
GEO	GEORGIA	4	0	4	4
GER	GERMANY	5	10	15	15
GRE	GREECE	4	3	7	7
HUN	HUNGARY	2	0	2	2
IRL	IRELAND	1	0	1	1
ITA	ITALY	21	14	35	35
KOS	KOSOVO	0	2	2	2
LAT	LATVIA	2	2	4	4
LUX	LUXEMBOURG	0	1	1	1
MNE	MONTENEGRO	2	0	2	2
NED	NETHERLANDS	4	4	8	8
MKD	NORTH MACEDONIA	1	1	2	2
POL	POLAND	1	4	5	5
POR	PORTUGAL	4	6	10	10
ROU	ROMANIA	3	0	3	3
SCO	SCOTLAND	0	2	2	2
SRB	SERBIA	1	0	1	1
SVK	SLOVAKIA	3	1	4	4
SLO	SLOVENIA	0	1	1	1
ESP	SPAIN	0	7	7	7
SWE	SWEDEN	1	3	4	4
SUI	SWITZERLAND	1	5	6	6
TUR	TURKIYE	13	12	25	25
UKR	UKRAINE	8	4	12	12
Total	EUROPE	37	112	115	227
	OCEANIA				
AUS	AUSTRALIA	1	1	2	2
Total	OCEANIA	1	1	2	2
	PAN AMERICA				
BRA	BRAZIL	1	1	2	2
CAN	CANADA	0	4	4	4
CHI	CHILE	4	4	8	8
COL	COLOMBIA	1	2	3	3
CUR	CURACAO	1	0	1	1
ECU	ECUADOR	1	1	2	2
ESA	EL SALVADOR	0	1	1	1
GUA	GUATEMALA	1	0	1	1
PER	PERU	0	1	1	1



NUMBER OF ENTRIES BY COUNTRY AND CONTINENT



Karate1 Premier League - Paris 2025

As of 27 JAN 2025

Country Code	Continent / Country	Male Entries	Female Entries	Total Entries	Total Athletes
PUR	PUERTO RICO	0	1	1	1
USA	UNITED STATES	4	2	6	6
VEN	VENEZUELA	2	3	5	5
Total	PAN AMERICA	12	20	35	35
Total		70	186	375	375



Karate1 Premier League - Paris 2025



ENTRIES BY NATIONAL FEDERATION

As of 27 JAN 2025

Country Code	ID	Gender	Name	Event	Seed
ALB	ALB2002	M	ARIFI ORGES	Male Kumite -60 Kg	11
	ALB02650	M	GASHI MELOS	Male Kumite -84 Kg	16
ALG	ALG02552	M	AYOUB ANIS HALASSA	Male Kumite -67 Kg	10
	ALG09842	M	BENMEKHLOUF SABER	Male Kata	21
	ALG2163	M	Daikhi Hocine	Male Kumite 84+ Kg	10
	ALG04850	M	MIDOUNE FALLEH	Male Kumite -84 Kg	15
	ALG04187	M	Zaid Oussama	Male Kumite -75 Kg	18
	ALG02679	F	ABOURICHE LOUIZA	Female Kumite -55 Kg	4
	ALG11679	F	DAHLEB NARIMENE	Female Kata	24
	ALG2482	F	OUDIRA CHAIMA	Female Kumite 68+ Kg	23
	ALG02678	F	Ouikene Cylia	Female Kumite -50 Kg	5
ARM	ARM2003	F	MAKYAN ANITA	Female Kumite -68 Kg	28
AUS	AUS264	M	TIELEN DANIEL	Male Kumite 84+ Kg	25
	AUS2194	F	SULLIVAN HANNAH	Female Kumite 68+ Kg	24
AUT	AUT2066	F	TOPALOVIC LEJLA	Female Kumite -61 Kg	10
	AUT2231	F	VUKOVIC MARINA	Female Kumite -68 Kg	29
AZE	AZE211	M	HASANOV TURGUT	Male Kumite -84 Kg	21
	AZE02341	M	RZAZADE NURAN	Male Kumite -67 Kg	14
	AZE2028	F	TEYMUROVA FIDAN	Female Kumite -50 Kg	20
BEL	BEL2201	M	ABDELMALKI ANASS	Male Kumite -60 Kg	8
	BEL226	M	Dasoul Michael	Male Kumite -60 Kg	21
	BEL2005	M	DEGHALI WALID	Male Kumite -84 Kg	14
	BEL2033	M	MAHAUDEN QUENTIN	Male Kumite -75 Kg	7
	BEL2030	M	OUALAD HAJ AMAR YOUNESS	Male Kumite -67 Kg	23
	BEL02934	F	AJARAY MARYAM	Female Kumite -61 Kg	2
	BEL02370	F	MANCA CHIARA	Female Kata	23
BIH	BIH2179	M	BOSTANDZIC ANES	Male Kumite 84+ Kg	2
	BIH2269	F	KRESIC STEFANI	Female Kumite 68+ Kg	13
	BIH2110	F	Sipovic Emina	Female Kumite -61 Kg	24
	BIH2111	F	SIPOVIC NEJRA	Female Kumite -55 Kg	30
BRA	BRA299	M	FIGUEIRA VINICIUS	Male Kumite -67 Kg	3
	BRA2042	F	RODRIGUES BARBARA	Female Kumite -61 Kg	26
BUL	BUL304	F	GORANOVA IVET	Female Kumite -55 Kg	27
	BUL2210	F	TSANEVA TEODORA	Female Kumite -50 Kg	18
CAN	CAN245	F	FURUMOTO-DESHAIES HANA	Female Kumite -55 Kg	6
	CAN2249	F	LAHYANSSA YAMINA	Female Kumite -50 Kg	9
	CAN2109	F	LAOS-LOO CLAUDIA	Female Kata	29
	CAN2308	F	NOLET LILY-ROSE	Female Kumite 68+ Kg	20
CHI	CHI2097	M	FREIRE FUENTES TOMAS	Male Kumite -67 Kg	9
	CHI128	M	GONZALEZ LAVIN JOAQUIN	Male Kumite -75 Kg	30
	CHI139	M	ROJAS RODRIGO	Male Kumite 84+ Kg	12
	CHI2062	M	VILLALON RUIZ ENRIQUE	Male Kumite -60 Kg	26
	CHI129	F	GONZALEZ LAVIN JAVIERA	Female Kumite 68+ Kg	18



Karate1 Premier League - Paris 2025



ENTRIES BY NATIONAL FEDERATION

As of 27 JAN 2025

Country Code	ID	Gender	Name	Event	Seed
CHI	CHI2361	F	HUAIQUIMAN BARBARA	Female Kumite -61 Kg	29
	CHI2015	F	TORO MENESES VALENTINA	Female Kumite -55 Kg	1
	CHI03118	F	VELOZO ANASTASIIA	Female Kumite -68 Kg	20
TPE	TPE2046	M	SHIH CHENG-CHUNG	Male Kumite -67 Kg	12
	TPE02416	F	CHAN HSIN-YU	Female Kumite -50 Kg	27
	TPE179	F	CHIEN HUI HSUAN	Female Kata	31
	TPE159	F	KU TSUI-PING	Female Kumite -55 Kg	7
COL	COL02565	M	FORERO JUAN DAVID	Male Kumite -60 Kg	9
	COL2195	F	CARDENAS BALCAZAR SOFIA	Female Kumite -50 Kg	7
	COL2228	F	ZAPATA MACHADO VALENTINA	Female Kata	11
CRO	CRO2872	M	GONDI NIKOLA	Male Kumite 84+ Kg	26
	CRO367	M	KVESIC ANDJELO	Male Kumite 84+ Kg	4
	CRO399	M	KVESIC IVAN	Male Kumite -84 Kg	6
	CRO2104	F	BECIROVIC SADEA	Female Kumite -68 Kg	27
	CRO2627	F	CAKCO MIA	Female Kumite -61 Kg	27
	CRO404	F	HASANI ALESSANDRA	Female Kumite -55 Kg	26
	CRO2077	F	LESJAK LUCIJA	Female Kumite 68+ Kg	10
	CRO2250	F	VUKOJA LEA	Female Kumite -68 Kg	15
CUR	CUR2120	M	Timmermans Rob	Male Kumite 84+ Kg	7
CYP	CYP02713	F	GIAMOUKI THEODOSIA	Female Kumite 68+ Kg	22
	CYP2131	F	KONTOU IRENE	Female Kumite -50 Kg	26
CZE	CZE2153	M	BOSAK ONDREJ	Male Kumite 84+ Kg	24
	CZE213	F	MISKOVA VERONIKA	Female Kata	25
ECU	ECU02313	M	Acevedo Jose	Male Kumite -84 Kg	19
	ECU128	F	FACTOS JACQUELIN	Female Kumite -61 Kg	19
EGY	EGY2218	M	Abdelaziz Abdalla	Male Kumite -75 Kg	1
	EGY2524	M	Abdelgawad Abdalla Hesham	Male Kumite -75 Kg	13
	EGY2635	M	Aboukora Amr Alaa	Male Kumite -60 Kg	13
	EGY2208	M	Aly Zyad	Male Kumite -60 Kg	31
	EGY2625	M	Badawy Youssef	Male Kumite -84 Kg	2
	EGY383	M	Elmasry Ahmed	Male Kumite 84+ Kg	18
	EGY319	M	Elsawy Ali	Male Kumite -67 Kg	15
	EGY2205	M	MAHMOUD TAHA TAREK	Male Kumite 84+ Kg	1
	EGY2544	M	Mohamed Hazem	Male Kumite 84+ Kg	22
	EGY2220	F	ABDELAZIZ FERYAL	Female Kumite -68 Kg	24
	EGY2627	F	ALY NOURSIN	Female Kumite -61 Kg	9
	EGY2732	F	HELMY HABIBA	Female Kumite 68+ Kg	30
	EGY2194	F	HENDY HADIR	Female Kumite -68 Kg	18
	EGY387	F	Hesham Aya	Female Kata	15
	EGY2528	F	Salama Reem Ahmed	Female Kumite -50 Kg	3
	EGY2630	F	YOUSSEF AHLAM	Female Kumite -55 Kg	10
ESA	ESA2056	F	IZAGUIRRE GABRIELLA	Female Kumite -50 Kg	22
ENG	ENG2358	M	Harrison James	Male Kata	25
	ENG2372	M	Wilson Joby	Male Kumite -67 Kg	29

Report Created: 27 JAN 2025

2 / 9



Karate1 Premier League - Paris 2025



ENTRIES BY NATIONAL FEDERATION

As of 27 JAN 2025

Country Code	ID	Gender	Name	Event	Seed
ENG	ENG297	F	Pomeroiy Jasmine	Female Kumite -61 Kg	28
	ENG2163	F	Salisbury Lauren	Female Kumite -68 Kg	30
	ENG2406	F	WALTERS ROCHELLE	Female Kumite 68+ Kg	5
FIN	FIN2013	M	Kulovuori Bjorn	Male Kumite -84 Kg	32
	FIN2061	M	Mantere Niko	Male Kumite -84 Kg	31
FRA	FRA02858	M	Assemat Hugo	Male Kumite -75 Kg	31
	FRA2231	M	BERTHON ENZO	Male Kumite -75 Kg	3
	FRA2234	M	CIZO KILIAN	Male Kumite -75 Kg	25
	FRA2077	M	Filali Mehdi	Male Kumite 84+ Kg	6
	FRA02768	M	HELLAL Amine	Male Kumite -60 Kg	23
	FRA04085	M	KLEMZ Thomas	Male Kata	18
	FRA2195	M	LE THANH LIEM	Male Kumite -75 Kg	23
	FRA02889	M	MEZIANE RAYYAN	Male Kumite -60 Kg	12
	FRA2191	M	NGOAN Franck	Male Kata	29
	SD65094	M	Salmi Younesse	Male Kumite -67 Kg	21
	FRA03559	M	TAS SAMI	Male Kumite -60 Kg	30
	FRA03560	M	TAS YANIS	Male Kumite -67 Kg	17
	FRA02870	M	ZOUAOUI AMIR	Male Kumite 84+ Kg	16
	FRA03633	F	ABDESSELEM Silya	Female Kumite -55 Kg	21
	FRA357	F	AGIER ALIZEE	Female Kumite -68 Kg	3
	FRA2379	F	AHMED Niswa	Female Kumite -50 Kg	29
	FRA599	F	Avazeri Lea	Female Kumite -61 Kg	12
	SD68835	F	BONNARDE Tiphaine	Female Kumite -50 Kg	24
	FRA02769	F	BREUZARD CHLOE	Female Kumite -50 Kg	17
	FRA372	F	GARCIA NANCY	Female Kumite 68+ Kg	6
	FRA02723	F	SOMBE Thalya	Female Kumite -68 Kg	4
	FRA02938	F	TAILY Helvetia	Female Kata	22
	FRA02778	F	YVON Sydney	Female Kumite -61 Kg	14
	FRA2566	F	ZAMETO HILLARY JENNIFER	Female Kumite -61 Kg	22
GEO	GEO02419	M	GELASHVILI MERABI	Male Kumite 84+ Kg	17
	GEO02275	M	PONIAVA VALIKO	Male Kumite -75 Kg	20
	GEO154	M	Tkebuchava David	Male Kumite -60 Kg	28
	GEO2152	M	VASADZE LUKA	Male Kumite -84 Kg	13
GER	GER2184	M	HAAS FLORIAN	Male Kumite -60 Kg	20
	GER2481	M	HAUBOLD JANNE	Male Kumite -84 Kg	28
	GER03121	M	OBITZ FLORIAN	Male Kumite -60 Kg	17
	GER2584	M	OEZDEMIR MUHAMMED	Male Kumite -67 Kg	7
	GER03153	M	SEKOT NIKOLAI	Male Kumite 84+ Kg	15
	GER2519	F	BITSCH MIA	Female Kumite -55 Kg	2
	GER2084	F	BUGUR GIZEM	Female Kumite -55 Kg	28
	GER2484	F	Bugur Seden	Female Kumite -50 Kg	23
	GER2252	F	HUBRICH SHARA	Female Kumite -50 Kg	12
	GER289	F	JUETTNER JASMIN	Female Kata	21
	GER03113	F	KHAMIS REEM	Female Kumite -61 Kg	1
	GER2090	F	KNEER JOHANNA	Female Kumite 68+ Kg	3
	GER2565	F	LUECKE AMELIE	Female Kumite 68+ Kg	11



Karate1 Premier League - Paris 2025



ENTRIES BY NATIONAL FEDERATION

As of 27 JAN 2025

Country Code	ID	Gender	Name	Event	Seed
GER	GER2080	F	SCHROETER MADELEINE	Female Kumite -68 Kg	19
	GER411	F	Yildirim Meryem	Female Kumite 68+ Kg	32
GRE	GRE02321	M	BALLOTIS GEORGIOS	Male Kumite -67 Kg	20
	GRE377	M	KARALIS GEORGIOS	Male Kumite -60 Kg	18
	GRE487	M	MASTROGIANNIS KONSTANTINOS	Male Kumite -84 Kg	3
	GRE521	M	XENOS CHRISTOS-STEFANOS	Male Kumite -60 Kg	3
	GRE2036	F	PEPPA KONSTANTINA-EVANGELIA	Female Kumite -68 Kg	22
	GRE2076	F	Stoli Maria	Female Kumite -55 Kg	3
	GRE308	F	XENOU GEORGIA ARCHONTIA	Female Kata	18
GUA	GUA2037	M	MALDONADO ALLAN	Male Kumite -75 Kg	19
HKG	HKG162	M	Hung Ho Wai Howard	Male Kata	27
	HKG177	F	LAU MO SHEUNG GRACE	Female Kata	1
	HKG2148	F	WONG CHEUK LEE	Female Kumite -68 Kg	13
HUN	HUN2338	M	BARDOS ADAM	Male Kata	26
	HUN196	M	NAGY BOTOND	Male Kata	20
INA	INA2001	F	AGUNG SANISTYARANI COK ISTRI	Female Kumite -55 Kg	12
	INA66e2ee6e40fe9	F	ZEFANYA CEYCO GEORGIA	Female Kumite -68 Kg	8
IRL	IRL2137	M	O SULLIVAN CONOR	Male Kumite -67 Kg	22
IRI	IRI2024	M	ABAZARI SALEH	Male Kumite 84+ Kg	3
	IRI187	M	ASGARI GHONCHEH BAHMAN	Male Kumite -75 Kg	10
	SD69128	M	ASHOURI GARMJANI MAHDI	Male Kumite 84+ Kg	20
	IRI03111	M	Borzooeichaghagolani Amirreza	Male Kumite -67 Kg	30
	IRI195	M	GANJZADEH SAJAD	Male Kumite 84+ Kg	27
	IRI2164	M	KHODABAKHSHI MAHDI	Male Kumite -84 Kg	17
	IRI2143	M	Meskini Ali	Male Kumite -60 Kg	29
	IRI291	F	AFSANEH MAHSA	Female Kata	28
	IRI2134	F	BAHMANYAR SARA	Female Kumite -50 Kg	30
	IRI02709	F	GOLSHADNEZHAD ATOUSA	Female Kumite -61 Kg	5
	IRI2132	F	HEYDARIOZOMCHELOE MOBINA	Female Kumite -68 Kg	11
	IRI212	F	Khaksar Taravat	Female Kumite -55 Kg	29
	SD73925	F	MOHSENIAN MASOUMEH	Female Kumite -50 Kg	19
IRI287	F	SADEGHI DASTAK FATEMEH	Female Kata	26	
ITA	ITA04245	M	Astarita Raffaele	Male Kumite -67 Kg	24
	ITA02948	M	AVANZINI matteo	Male Kumite 84+ Kg	8
	ITA322	M	Busato Mattia	Male Kata	12
	ITA266	M	CRESCENZO Angelo	Male Kumite -60 Kg	7
	ITA2510	M	De Vivo Daniele	Male Kumite -75 Kg	11
	ITA259	M	De Vivo Gianluca	Male Kumite -67 Kg	13
	ITA2508	M	Fiore Matteo	Male Kumite -84 Kg	10
	ITA2058	M	Gallo Gianluca	Male Kata	28
	ITA2507	M	GHINAMI ALESSIO	Male Kata	7
	ITA2796	M	GHISLANDI MICHAEL	Male Kumite 84+ Kg	30
	ITA03142	M	Grazia Manuel	Male Kata	31
ITA2137	M	GRECO DANILLO	Male Kumite -60 Kg	10	



Karate1 Premier League - Paris 2025



ENTRIES BY NATIONAL FEDERATION

As of 27 JAN 2025

Country Code	ID	Gender	Name	Event	Seed	
ITA	ITA327	M	Iodice Alessandro	Male Kata	15	
	ITA2509	M	Luciano Carmine	Male Kumite -60 Kg	15	
	ITA329	M	Maresca Luca	Male Kumite -67 Kg	4	
	ITA396	M	marino simone	Male Kumite 84+ Kg	29	
	ITA494	M	Martina Michele	Male Kumite -84 Kg	11	
	ITA552	M	Pietromarchi Lorenzo	Male Kumite -75 Kg	15	
	ITA2746	M	Rossi Joseph	Male Kumite -75 Kg	24	
	ITA2511	M	Ruggiero Rosario	Male Kumite -67 Kg	26	
	ITA03865	M	Sabatino Christian	Male Kumite -60 Kg	24	
	ITA2512	F	AGUS ASIA	Female Kumite -50 Kg	14	
	ITA2128	F	amato carolina	Female Kata	27	
	ITA2385	F	Bodei Pamela	Female Kumite -68 Kg	14	
	ITA2132	F	BRUNORI VERONICA	Female Kumite -55 Kg	13	
	ITA2129	F	Casale Carola	Female Kata	14	
	ITA04298	F	COLLETTI EMMA	Female Kumite -50 Kg	16	
	ITA308	F	D ONOFRIO Terryana	Female Kata	7	
	ITA04269	F	DESIDERIO ANNA PIA	Female Kumite -68 Kg	17	
	ITA570	F	Ferracuti Clio	Female Kumite 68+ Kg	4	
	ITA03155	F	Graziosi Aurora	Female Kumite -61 Kg	23	
	ITA395	F	Lallo viola	Female Kumite -55 Kg	8	
	ITA2401	F	Mancinelli Syria	Female Kumite -55 Kg	16	
	ITA376	F	Perfetto Erminia	Female Kumite -50 Kg	6	
	ITA377	F	SEMERARO Silvia	Female Kumite -68 Kg	7	
	JPN	JPN2396	M	ETO JUNYA	Male Kumite -84 Kg	18
		JPN03258	M	HASHIMOTO HIROMU	Male Kumite -60 Kg	1
		JPN2278	M	Ikeda Ryusei	Male Kata	5
		JPN2182	M	Kikuchi Ryonosuke	Male Kata	10
		JPN2077	M	Kozaki Yugo	Male Kumite -67 Kg	2
		SD59454	M	MACHIDA YASUHIRO	Male Kata	8
		JPN2058	M	Moto Kazumasa	Male Kata	4
		JPN2290	M	Moto Ryuji	Male Kata	6
		JPN2470	M	Nishiyama Kakeru	Male Kata	1
		JPN2313	M	Sakiyama Yusei	Male Kumite -75 Kg	9
SD59618		M	Sato Yuki	Male Kata	24	
JPN2314		M	Shimada Rikito	Male Kumite -84 Kg	5	
JPN2661		M	Suzuki Shunji	Male Kumite -75 Kg	26	
SD63542		M	yatoji yoshihito	Male Kumite -60 Kg	16	
JPN02706		M	Yoshimura Fumiya	Male Kumite 84+ Kg	14	
JPN02844		F	Azuma Saeko	Female Kata	6	
SD65523		F	hisami Nakaji	Female Kata	16	
JPN03040		F	KAMA TSUBASA	Female Kumite -68 Kg	2	
SD70419		F	Kitaguchi Kao	Female Kata	20	
SD77050		F	KODO RINA	Female Kumite -55 Kg	15	
JPN03368		F	MISHIMA KIRI	Female Kata	3	
SD79143		F	Nagai Kanna	Female Kumite -68 Kg	26	
JPN02704		F	OKAZAKI AIKA	Female Kumite -50 Kg	15	
JPN2451		F	Ono Maho	Female Kata	2	



Karate1 Premier League - Paris 2025



ENTRIES BY NATIONAL FEDERATION

As of 27 JAN 2025

Country Code	ID	Gender	Name	Event	Seed
JPN	JPN2072	F	SHIMA AIRI	Female Kumite -55 Kg	5
	JPN02840	F	Shimada Sarara	Female Kumite -61 Kg	4
	JPN253	F	Shimizu Natsuki	Female Kata	17
	JPN03042	F	TSUTSUMI SARA	Female Kumite -50 Kg	11
JOR	JOR2281	M	ALJAFARI MOHAMMAD	Male Kumite -84 Kg	1
	JOR2159	M	GHAITH AFEEF	Male Kumite -67 Kg	5
	JOR2164	M	MASARWEH HASAN	Male Kumite -75 Kg	14
	JOR2161	M	Shaqrah Omar	Male Kumite -60 Kg	27
KAZ	KAZ2006	M	ALPYSBAY KAISAR	Male Kumite -60 Kg	5
	KAZ2300	M	ANARBEKOV DIAS	Male Kumite 84+ Kg	13
	KAZ2028	M	AZHIKANOV NURKANAT	Male Kumite -75 Kg	2
	KAZ212	M	YULDASHEV DANİYAR	Male Kumite -84 Kg	9
	KAZ2140	F	BERULTSEVA SOFYA	Female Kumite 68+ Kg	1
	KAZ2198	F	KANAY ASSEL	Female Kumite -61 Kg	3
	KAZ02650	F	SAGYNBEK LAURA	Female Kumite -68 Kg	23
	KAZ66e2ee6e1e9d6	F	USSENOVA GULMIRA	Female Kumite -55 Kg	11
	KAZ2019	F	ZHANGBYRBAY MOLDIR	Female Kumite -50 Kg	2
KOS	KOS2051	F	ISTOGU ELMEDINA	Female Kumite -61 Kg	30
	KOS2014	F	ORANA FORTESA	Female Kumite 68+ Kg	27
KUW	KUW2002	M	ALJENAEI OMAR	Male Kumite -75 Kg	21
	KUW186	M	ALMOSAWI SAYED SALMAN	Male Kata	14
	KUW188	M	SHAABAN ABDULLAH	Male Kumite -60 Kg	2
LAT	SD24496	M	SADIKOV DENS	Male Kumite -84 Kg	26
	LAT2084	M	STEPANOV ARTUR	Male Kumite -67 Kg	18
	LAT02561	F	GIRVICA BEATA	Female Kumite -61 Kg	25
	LAT2021	F	MUIZNIECE MARIJA LUIZE	Female Kumite -55 Kg	22
LBA	LBA02377	M	ABUDABOVS MOHAMED	Male Kumite -75 Kg	12
LUX	LUX124	F	WARLING JENNIFER	Female Kumite -55 Kg	14
MAS	MAS02418	F	CHANDRAN SHAHMALARANI	Female Kumite -50 Kg	8
MNE	MNE246	M	MALOVIC NIKOLA	Male Kumite -84 Kg	22
	MNE2045	M	MIKULIC NEMANJA	Male Kumite -75 Kg	17
MAR	MAR2271	M	OUBAYA SAID	Male Kumite -67 Kg	1
	MAR2275	M	SRITI MEHDI	Male Kumite -84 Kg	12
	MAR2238	F	BROUK NISRINE	Female Kumite -68 Kg	31
	MAR2270	F	chajai fatima-zahra	Female Kumite -61 Kg	7
	MAR02618	F	EDDARHRI Maroua	Female Kumite 68+ Kg	12
	MAR2034	F	EN-NESYRY AYA	Female Kata	8
NED	NED02684	M	FRANKEN RICARDO	Male Kumite -75 Kg	16
	NED2271	M	Najdi Issam	Male Kumite 84+ Kg	28
	NED2342	M	Teeffelen van Sebastiaan	Male Kumite -75 Kg	27
	NED2028	M	Timmermans Brian	Male Kumite -84 Kg	8
	NED221	F	Creemers Ingrid	Female Kumite 68+ Kg	21



Karate1 Premier League - Paris 2025



ENTRIES BY NATIONAL FEDERATION

As of 27 JAN 2025

Country Code	ID	Gender	Name	Event	Seed
NED	NED02396	F	Kakiay Ashley	Female Kumite -61 Kg	20
	NED2346	F	van Wezel Robin	Female Kumite 68+ Kg	31
	NED02464	F	YALCIN Samina	Female Kumite -50 Kg	31
MKD	MKD285	M	Spasenovski Petar	Male Kumite -84 Kg	27
	MKD367	F	KOSTOVSKA VERONIKA	Female Kumite -61 Kg	21
PER	PER129	F	Grande Alexandra	Female Kumite -61 Kg	11
PHI	PHI02129	F	ALFORTE SAKURA	Female Kata	12
POL	POL2671	M	FLORCZAK MICHAL	Male Kumite -84 Kg	29
	POL4033	F	DANISZEWSKA JULIA	Female Kumite 68+ Kg	14
	POL08881	F	DRONCHANKA KSENIYA	Female Kumite -55 Kg	19
	POL3057	F	GREJNER WIKTORIA	Female Kumite -68 Kg	21
	POL06896	F	LEWANDOWSKA KATARZYNA	Female Kumite -61 Kg	18
POR	POR2265	M	Duarte Rafael	Male Kumite -67 Kg	25
	POR2177	M	Duarte Tiago	Male Kumite -75 Kg	22
	POR2170	M	MENDES JOAQUIM	Male Kumite -67 Kg	8
	POR2086	M	NUNES RIBEIRO DIOGO MIGUEL	Male Kumite -67 Kg	16
	POR2092	F	Almeida Baptista Renata	Female Kumite -61 Kg	31
	POR228	F	CRUZ ANA	Female Kata	13
	POR2262	F	Fernandes Natacha	Female Kata	30
	POR02873	F	MARQUES RITA	Female Kata	9
	POR251	F	OLIVEIRA ANA RITA	Female Kumite 68+ Kg	17
	POR2187	F	Rodrigues Catarina	Female Kumite -50 Kg	10
PUR	PUR2007	F	FONSECA ROMERO JANESEA MICHELLE	Female Kumite -68 Kg	6
ROU	ROU2273	M	BAICU ORLANDO	Male Kumite -67 Kg	28
	ROU2480	M	COMANESCU PETRU	Male Kata	22
	ROU267	M	GOGOLOSI BOGDAN MARIAN FLORIN	Male Kumite -60 Kg	14
KSA	KSA03353	M	ALARIANI ALI	Male Kumite -60 Kg	25
SCO	SCO171	F	Connell Amy	Female Kumite -55 Kg	32
	SCO2098	F	JUNNER NIAMH	Female Kumite 68+ Kg	9
SEN	SEN02471	M	DIOP MAKHTAR	Male Kumite -84 Kg	25
SRB	SRB526	M	Tesanovic Djordje	Male Kumite 84+ Kg	21
SVK	SVK296	M	HOMOLA MATEJ	Male Kumite -67 Kg	11
	SVK2199	M	HRCKA ROMAN	Male Kata	30
	SVK327	M	Smoliga Julian Enrik	Male Kumite -84 Kg	30
	SVK2293	F	VARGOVA NATALIA	Female Kumite -50 Kg	4
SLO	SLO2448	F	ZIBRET ZALA MARIA	Female Kumite 68+ Kg	26
ESP	ESP02672	F	GARCIA LOZANO PAOLA	Female Kata	10
	ESP2197	F	LORENZO COUSO RUTH	Female Kumite -55 Kg	31
	ESP2359	F	NIETO MEJIAS MARIA ISABEL	Female Kumite -68 Kg	5
	ESP2263	F	PEREIRA VILLALOBOS SONIA	Female Kumite -55 Kg	25



Karate1 Premier League - Paris 2025



ENTRIES BY NATIONAL FEDERATION

As of 27 JAN 2025

Country Code	ID	Gender	Name	Event	Seed
ESP	ESP03590	F	RODRIGUEZ LOREDO EVA	Female Kumite -50 Kg	28
	ESP2007	F	TORRES GARCIA MARIA	Female Kumite 68+ Kg	2
	ESP02988	F	ZUNIGA GARCIA INDIRA	Female Kumite -61 Kg	15
SWE	SWE02584	M	VU ANTHONY	Male Kata	9
	SWE02480	F	BAO BEDNARSKI SOPHIE	Female Kumite 68+ Kg	28
	SWE201	F	NILSSON ANNA-JOHANNA	Female Kumite -61 Kg	8
	SWE2151	F	ROSENLIND MATILDA	Female Kumite -55 Kg	17
SUI	SUI2121	M	UJIHARA YUKI	Male Kata	19
	SUI2030	F	BONJOUR PAULINE	Female Kumite 68+ Kg	19
	SUI2005	F	KAUFMANN FABIENNE	Female Kumite 68+ Kg	7
	SUI202	F	QUIRICI ELENA	Female Kumite -68 Kg	1
	SUI2015	F	RADJENOVIC NINA	Female Kumite -61 Kg	17
	SUI267	F	SCHAERER MAYA	Female Kumite -55 Kg	23
THA	THA2221	M	MUEKTHONG SIWAKON	Male Kumite -60 Kg	22
TUN	TUN2275	M	CHOIYA HOUSSEM EDIN	Male Kumite 84+ Kg	9
	TUN02791	M	HADDAJI LAITH	Male Kumite -67 Kg	27
	TUN02803	F	ETTALEB MERIAME	Female Kumite -68 Kg	25
	TUN02793	F	EZZAR WISSAL	Female Kumite -68 Kg	12
	TUN203	F	JEMI CHEHINEZ	Female Kumite 68+ Kg	8
TUR	TUR2211	M	ARSLAN HASAN	Male Kumite -84 Kg	7
	TUR644	M	BULUT ENES	Male Kumite -75 Kg	5
	TUR04289	M	GUNDOG UMUT EREN	Male Kumite 84+ Kg	19
	TUR2663	M	HALICI MERT	Male Kumite -60 Kg	6
	TUR802	M	KAYALI FURKAN	Male Kumite 84+ Kg	23
	TUR3045	M	KOC TARIK	Male Kata	17
	TUR675	M	OZDEMIR BURAK	Male Kumite -60 Kg	19
	TUR2430	M	OZDEMIR ENES	Male Kata	11
	TUR2050	M	OZER OMER ABDURRAHIM	Male Kumite -67 Kg	6
	TUR632	M	SAMDAN ERAY	Male Kumite -60 Kg	4
	TUR353	M	SOFUOGLU ALI	Male Kata	3
	TUR03291	M	TEMIZEL YUSUF EREN	Male Kumite -84 Kg	23
	TUR2674	M	YURUR OMER FARUK	Male Kumite -75 Kg	4
	TUR2420	F	AKSOY SUDENUR	Female Kumite -68 Kg	9
	TUR713	F	BOZAN DILARA	Female Kata	5
	TUR2858	F	COLAK KEYDA NUR	Female Kata	19
	TUR786	F	ELTEMUR EDA	Female Kumite -68 Kg	16
	TUR04113	F	gaballa zeyna	Female Kumite 68+ Kg	29
	TUR794	F	GOZUTOK GULBAHAR	Female Kumite -61 Kg	16
	TUR308	F	HOCAGLU AKYOL MELTEM	Female Kumite 68+ Kg	15
	TUR03944	F	IM ZUMRA REZZAN	Female Kumite -55 Kg	20
	TUR552	F	KUCUKOGLU SELVA NUR AKKURT	Female Kumite -50 Kg	21
	TUR2415	F	UYGUR FATMA	Female Kumite 68+ Kg	25
	TUR2023	F	YAKAN TUBA	Female Kumite -55 Kg	9
	TUR2604	F	YENEN FATMA NAZ	Female Kumite -61 Kg	6
TKM	TKM02089	M	NAZMYRADOV DAVUT	Male Kumite -75 Kg	29



Karate1 Premier League - Paris 2025



ENTRIES BY NATIONAL FEDERATION

As of 27 JAN 2025

Country Code	ID	Gender	Name	Event	Seed
UKR	UKR274	M	CHOBOTAR VALERII	Male Kumite -84 Kg	4
	UKR02683	M	Pitsul Heorhii	Male Kumite -75 Kg	8
	UKR02715	M	RAHOZENKO ERIK	Male Kumite -75 Kg	28
	UKR2087	M	SONNYKH VALERII	Male Kumite -84 Kg	24
	UKR2020	M	TALIBOV RYZVAN	Male Kumite 84+ Kg	5
	UKR2021	M	TOROSHANKO ANDRII	Male Kumite -84 Kg	20
	UKR2368	M	YANOVSKYI DAVYD	Male Kumite -67 Kg	19
	UKR2204	M	ZAPLITNYI ANDRII	Male Kumite -75 Kg	6
	UKR2269	F	PALASHEVSKA YULIYA	Female Kumite -50 Kg	13
	UKR02524	F	RUSU YULIA	Female Kumite 68+ Kg	16
	UKR2280	F	SHOLOHOVA OLEKSANDRA	Female Kumite -61 Kg	13
	UKR2373	F	SIELIEMIENIEVA ELINA	Female Kumite -68 Kg	10
	UAE	UAE2003	F	Alajmi Hawraa	Female Kumite -50 Kg
USA	USA2080	M	CHINEN REY	Male Kata	13
	USA03000	M	SAGILYAN EDUARD	Male Kumite 84+ Kg	11
	USA283	M	TORRES GUTIERREZ ARIEL	Male Kata	2
	USA182	M	TOZAKI GAKUJI	Male Kata	23
	USA2034	F	ALLEN TRINITY	Female Kumite -55 Kg	18
	USA196	F	KOKUMAI SAKURA	Female Kata	4
VEN	VEN192	M	CASANOVA GUERRERO CLEIVER	Male Kata	16
	VEN2329	M	Perez De Abreu Ricardo	Male Kata	32
	VEN232	F	ARMADA RUIZ ANDREA	Female Kata	32
	VEN2096	F	Perez Barbara	Female Kumite -55 Kg	24
	VEN297	F	salazar yorgelis	Female Kumite -50 Kg	1



Karate1 Premier League - Paris 2025



Statistics

Participating Countries: 70

	Competitors	Entries
Female	189	189
Male	186	186
Total	375	375

Entries per Category

	Entries	Teams
Female Kata	32	-
Female Kumite -50 Kg	31	-
Female Kumite -55 Kg	32	-
Female Kumite -61 Kg	31	-
Female Kumite -68 Kg	31	-
Female Kumite 68+ Kg	32	-
Male Kata	32	-
Male Kumite -60 Kg	31	-
Male Kumite -67 Kg	30	-
Male Kumite -75 Kg	31	-
Male Kumite -84 Kg	32	-
Male Kumite 84+ Kg	30	-
Totals:	375	0

FEMALE KATA



Karate1 Premier League - Paris 2025

ENTRIES BY WEIGHT CATEGORY



Female Kata

As of 27 JAN 2025

Country Code	ID	Gender	Name	Seeding
ALG	ALG11679	F	DAHLEB NARIMENE	24
BEL	BEL02370	F	MANCA CHIARA	23
CAN	CAN2109	F	LAOS-LOO CLAUDIA	29
COL	COL2228	F	ZAPATA MACHADO VALENTINA	11
CZE	CZE213	F	MISKOVA VERONIKA	25
EGY	EGY387	F	Hesham Aya	15
ESP	ESP02672	F	GARCIA LOZANO PAOLA	10
FRA	FRA02938	F	TAILY Helvetia	22
GER	GER289	F	JUETTNER JASMIN	21
GRE	GRE308	F	XENOU GEORGIA ARCHONTIA	18
HKG	HKG177	F	LAU MO SHEUNG GRACE	1
IRI	IRI291	F	AFSANEH MAHSA	28
IRI	IRI287	F	SADEGHI DASTAK FATEMEH	26
ITA	ITA2128	F	amato carolina	27
ITA	ITA2129	F	Casale Carola	14
ITA	ITA308	F	D ONOFRIO Terryana	7
JPN	JPN02844	F	Azuma Saeko	6
JPN	SD65523	F	hisami Nakaji	16
JPN	SD70419	F	Kitaguchi Kao	20
JPN	JPN03368	F	MISHIMA KIRI	3
JPN	JPN2451	F	Ono Maho	2
JPN	JPN253	F	Shimizu Natsuki	17
MAR	MAR2034	F	EN-NESYRY AYA	8
PHI	PHI02129	F	ALFORTE SAKURA	12
POR	POR228	F	CRUZ ANA	13
POR	POR2262	F	Fernandes Natacha	30
POR	POR02873	F	MARQUES RITA	9
TPE	TPE179	F	CHIEN HUI HSUAN	31
TUR	TUR713	F	BOZAN DILARA	5
TUR	TUR2858	F	COLAK KEYDA NUR	19
USA	USA196	F	KOKUMAI SAKURA	4
VEN	VEN232	F	ARMADA RUIZ ANDREA	32

Female Kata - Round Robin (each against each)

Karate1 Premier League - Paris 2025, Pierre de Coubertin Stadium, Avenue George Lafont 82, 75016 Paris, FRA

Tatami

Pool
1/8



1	(*17) SHIMIZU N. (JPN)	048 Kusanku #1 / 24.01	4100	(*17) SHIMIZU N. (JPN)
2	(*32) ARMADA RUIZ A. (VEN)	009 Chibana No Kushanku	3950	
3	(*18) XENOU G. (GRE)	002 Anan Dai #2 / 24.01	3950	(*18) XENOU G. (GRE)
4	(*27) AMATO C. (ITA)	068 Papuren	3890	
5	(*32) ARMADA RUIZ A. (VEN)	064 Ohan Dai #5 / 24.01	3830	(*18) XENOU G. (GRE)
6	(*18) XENOU G. (GRE)	008 Chatanyara Kushanku	3970	
7	(*17) SHIMIZU N. (JPN)	068 Papuren #6 / 24.01	4140	(*17) SHIMIZU N. (JPN)
8	(*27) AMATO C. (ITA)	008 Chatanyara Kushanku	3790	
9	(*17) SHIMIZU N. (JPN)	047 Kururunfa #9 / 24.01	4140	(*17) SHIMIZU N. (JPN)
10	(*18) XENOU G. (GRE)	068 Papuren	3920	
11	(*32) ARMADA RUIZ A. (VEN)	068 Papuren #10 / 24.01	3850	(*32) ARMADA RUIZ A. (VEN)
12	(*27) AMATO C. (ITA)	092 Suparinpei	3820	

1. SHIMIZU NATSUKI (JPN)
2. XENOU GEORGIA ARCHONTIA (GRE)
3. ARMADA RUIZ ANDREA (VEN)
4. AMATO CAROLINA (ITA)

1. ONO MAHO (JPN)
2. LAU MO SHEUNG GRACE (HKG)
3. MISHIMA KIRI (JPN)
3. AZUMA SAEKO (JPN)
5. GARCIA LOZANO PAOLA (ESP)
5. MISKOVA VERONIKA (CZE)
7. SHIMIZU NATSUKI (JPN)
7. KOKUMAI SAKURA (USA)

*Seeded

Referees:			

Female Kata - Round Robin (each against each)

Karate1 Premier League - Paris 2025, Pierre de Coubertin Stadium, Avenue George Lafont 82, 75016 Paris, FRA

Tatami

Pool
2/8



1	(*14) CASALE C. (ITA)	092 Suparinpei #3 / 24.01	4020	(*14) CASALE C. (ITA)
2	(*15) HESHAM A. (EGY)	021 Gojushiho Sho	3930	
3	(*26) SADEGHI DASTAK F. (IRI)	002 Anan Dai #4 / 24.01	3950	(*3) MISHIMA K. (JPN)
4	(*3) MISHIMA K. (JPN)	068 Papuren	4150	
5	(*15) HESHAM A. (EGY)	020 Gojushiho Dai #7 / 24.01	4030	(*26) SADEGHI DASTAK F. (IRI)
6	(*26) SADEGHI DASTAK F. (IRI)	092 Suparinpei	4140	
7	(*14) CASALE C. (ITA)	068 Papuren #8 / 24.01	3940	(*3) MISHIMA K. (JPN)
8	(*3) MISHIMA K. (JPN)	067 Paiku	4200	
9	(*14) CASALE C. (ITA)	008 Chatanyara Kushanku #11 / 24.01	3980	(*26) SADEGHI DASTAK F. (IRI)
10	(*26) SADEGHI DASTAK F. (IRI)	068 Papuren	3980	
11	(*15) HESHAM A. (EGY)	041 Kanku Sho #12 / 24.01	3880	(*3) MISHIMA K. (JPN)
12	(*3) MISHIMA K. (JPN)	008 Chatanyara Kushanku	4200	

1. MISHIMA KIRI (JPN)
2. SADEGHI DASTAK FATEMEH (IRI)
3. CASALE CAROLA (ITA)
4. HESHAM AYA (EGY)

1. ONO MAHO (JPN)
2. LAU MO SHEUNG GRACE (HKG)
3. MISHIMA KIRI (JPN)
3. AZUMA SAEKO (JPN)
5. GARCIA LOZANO PAOLA (ESP)
5. MISKOVA VERONIKA (CZE)
7. SHIMIZU NATSUKI (JPN)
7. KOKUMAI SAKURA (USA)

*Seeded

Referees:			

Female Kata - Round Robin (each against each)

Karate1 Premier League - Paris 2025, Pierre de Coubertin Stadium, Avenue George Lafont 82, 75016 Paris, FRA

Tatami

Pool
3/8



1	(*12) ALFORTE S. (PHI) 047 Kururunfa #73 / 24.01 3950	(*13) CRUZ A. (POR) 002 Anan Dai 3980
2	(*13) CRUZ A. (POR) 002 Anan Dai 3980	(*10) GARCIA LOZANO P. (ESP) 068 Papuren 3990
3	(*20) KITAGUCHI K. (JPN) 009 Chibana No Kushanku #74 / 24.01 3850	(*10) GARCIA LOZANO P. (ESP) 068 Papuren 3990
4	(*10) GARCIA LOZANO P. (ESP) 068 Papuren 3990	(*20) KITAGUCHI K. (JPN) 068 Papuren 3830
5	(*13) CRUZ A. (POR) 008 Chatanyara Kushanku #77 / 24.01 3830	(*20) KITAGUCHI K. (JPN) 068 Papuren 3830
6	(*20) KITAGUCHI K. (JPN) 068 Papuren 3830	(*12) ALFORTE S. (PHI) 064 Ohan Dai #78 / 24.01 3790
7	(*12) ALFORTE S. (PHI) 064 Ohan Dai #78 / 24.01 3790	(*10) GARCIA LOZANO P. (ESP) 009 Chibana No Kushanku 3910
8	(*10) GARCIA LOZANO P. (ESP) 009 Chibana No Kushanku 3910	(*12) ALFORTE S. (PHI) 002 Anan Dai #81 / 24.01 3940
9	(*12) ALFORTE S. (PHI) 002 Anan Dai #81 / 24.01 3940	(*20) KITAGUCHI K. (JPN) 008 Chatanyara Kushanku 3870
10	(*20) KITAGUCHI K. (JPN) 008 Chatanyara Kushanku 3870	(*12) ALFORTE S. (PHI) 002 Anan Dai #81 / 24.01 3940
11	(*13) CRUZ A. (POR) 068 Papuren #82 / 24.01 3910	(*10) GARCIA LOZANO P. (ESP) 068 Papuren 3990
12	(*10) GARCIA LOZANO P. (ESP) 068 Papuren 3990	(*10) GARCIA LOZANO P. (ESP) 092 Suparinpei 4060

1. GARCIA LOZANO PAOLA (ESP)
2. KITAGUCHI KAO (JPN)
3. CRUZ ANA (POR)
4. ALFORTE SAKURA (PHI)

1. ONO MAHO (JPN)
2. LAU MO SHEUNG GRACE (HKG)
3. MISHIMA KIRI (JPN)
3. AZUMA SAEKO (JPN)
5. GARCIA LOZANO PAOLA (ESP)
5. MISKOVA VERONIKA (CZE)
7. SHIMIZU NATSUKI (JPN)
7. KOKUMAI SAKURA (USA)

*Seeded

Referees:			

Female Kata - Round Robin (each against each)

Karate1 Premier League - Paris 2025, Pierre de Coubertin Stadium, Avenue George Lafont 82, 75016 Paris, FRA

Tatami

Pool
4/8



1	(*11) ZAPATA MACHADO V. (COL)	009 Chibana No Kushanku3830 #75 / 24.01	(*11) ZAPATA MACHADO V. (COL)
2	(*22) TAILY H. (FRA)	020 Gojushiho Dai 3770	
3	(*19) COLAK K. (TUR)	001 Anan 3850 #76 / 24.01	(*2) ONO M. (JPN)
4	(*2) ONO M. (JPN)	061 Nipaipo 4180	
5	(*22) TAILY H. (FRA)	021 Gojushiho Sho 3920 #79 / 24.01	(*22) TAILY H. (FRA)
6	(*19) COLAK K. (TUR)	008 Chatanyara Kushanku3880	
7	(*11) ZAPATA MACHADO V. (COL)	008 Chatanyara Kushanku3980 #80 / 24.01	(*2) ONO M. (JPN)
8	(*2) ONO M. (JPN)	068 Papuren 4260	
9	(*11) ZAPATA MACHADO V. (COL)	068 Papuren 4050 #83 / 24.01	(*11) ZAPATA MACHADO V. (COL)
10	(*19) COLAK K. (TUR)	068 Papuren 3880	
11	(*22) TAILY H. (FRA)	015 Gankaku 4020 #84 / 24.01	(*2) ONO M. (JPN)
12	(*2) ONO M. (JPN)	092 Suparinpei 4270	

1. ONO MAHO (JPN)
2. ZAPATA MACHADO VALENTINA (COL)
3. TAILY HELVETIA (FRA)
4. COLAK KEYDA NUR (TUR)

1. ONO MAHO (JPN)
2. LAU MO SHEUNG GRACE (HKG)
3. MISHIMA KIRI (JPN)
3. AZUMA SAEKO (JPN)
5. GARCIA LOZANO PAOLA (ESP)
5. MISKOVA VERONIKA (CZE)
7. SHIMIZU NATSUKI (JPN)
7. KOKUMAI SAKURA (USA)

*Seeded

Referees:			

Female Kata - Round Robin (each against each)

Karate1 Premier League - Paris 2025, Pierre de Coubertin Stadium, Avenue George Lafont 82, 75016 Paris, FRA

Tatami

Pool
5/8



1	(*7) D ONOFRIO T. (ITA)	068 Papuren #142 / 24.01	4060	(*7) D ONOFRIO T. (ITA)
2	(*28) AFSANEH M. (IRI)	009 Chibana No Kushanku	3850	
3	(*6) AZUMA S. (JPN)	092 Suparinpei #143 / 24.01	4140	(*6) AZUMA S. (JPN)
4	(*30) FERNANDES N. (POR)	008 Chatanyara Kushanku	3860	
5	(*28) AFSANEH M. (IRI)	043 Kishimoto No Kushanku #146 / 24.01	3950	(*6) AZUMA S. (JPN)
6	(*6) AZUMA S. (JPN)	065 Oyadomari No Passai	4150	
7	(*7) D ONOFRIO T. (ITA)	092 Suparinpei #147 / 24.01	4180	(*7) D ONOFRIO T. (ITA)
8	(*30) FERNANDES N. (POR)	092 Suparinpei	3930	
9	(*7) D ONOFRIO T. (ITA)	009 Chibana No Kushanku #150 / 24.01	4060	(*6) AZUMA S. (JPN)
10	(*6) AZUMA S. (JPN)	009 Chibana No Kushanku	4200	
11	(*28) AFSANEH M. (IRI)	008 Chatanyara Kushanku #151 / 24.01	3940	(*30) FERNANDES N. (POR)
12	(*30) FERNANDES N. (POR)	068 Papuren	4000	

1. AZUMA SAEKO (JPN)
2. D ONOFRIO TERRYANA (ITA)
3. FERNANDES NATACHA (POR)
4. AFSANEH MAHSA (IRI)

1. ONO MAHO (JPN)
2. LAU MO SHEUNG GRACE (HKG)
3. MISHIMA KIRI (JPN)
3. AZUMA SAEKO (JPN)
5. GARCIA LOZANO PAOLA (ESP)
5. MISKOVA VERONIKA (CZE)
7. SHIMIZU NATSUKI (JPN)
7. KOKUMAI SAKURA (USA)

*Seeded

Referees:			

Female Kata - Round Robin (each against each)

Karate1 Premier League - Paris 2025, Pierre de Coubertin Stadium, Avenue George Lafont 82, 75016 Paris, FRA

Tatami

Pool
6/8



1	(*24) DAHLEB N. (ALG)	099 Unsu #144 / 24.01	3880	(*5) BOZAN D. (TUR)
2	(*5) BOZAN D. (TUR)	047 Kururunfa	3990	
3	(*23) MANCA C. (BEL)	008 Chatanyara Kushanku #145 / 24.01	3900	(*4) KOKUMAI S. (USA)
4	(*4) KOKUMAI S. (USA)	047 Kururunfa	4070	
5	(*5) BOZAN D. (TUR)	002 Anan Dai #148 / 24.01	3960	(*5) BOZAN D. (TUR)
6	(*23) MANCA C. (BEL)	068 Papuren	3820	
7	(*24) DAHLEB N. (ALG)	020 Gojushiho Dai #149 / 24.01	3880	(*4) KOKUMAI S. (USA)
8	(*4) KOKUMAI S. (USA)	009 Chibana No Kushanku	4050	
9	(*24) DAHLEB N. (ALG)	015 Gankaku #152 / 24.01	3770	(*23) MANCA C. (BEL)
10	(*23) MANCA C. (BEL)	064 Ohan Dai	3960	
11	(*5) BOZAN D. (TUR)	068 Papuren #153 / 24.01	4080	(*4) KOKUMAI S. (USA)
12	(*4) KOKUMAI S. (USA)	068 Papuren	4080	

1. KOKUMAI SAKURA (USA)
2. BOZAN DILARA (TUR)
3. MANCA CHIARA (BEL)
4. DAHLEB NARIMENE (ALG)

1. ONO MAHO (JPN)
2. LAU MO SHEUNG GRACE (HKG)
3. MISHIMA KIRI (JPN)
3. AZUMA SAEKO (JPN)
5. GARCIA LOZANO PAOLA (ESP)
5. MISKOVA VERONIKA (CZE)
7. SHIMIZU NATSUKI (JPN)
7. KOKUMAI SAKURA (USA)

*Seeded

Referees:			

Female Kata - Round Robin (each against each)

Karate1 Premier League - Paris 2025, Pierre de Coubertin Stadium, Avenue George Lafont 82, 75016 Paris, FRA

Tatami

Pool
7/8



1	(*8) EN-NESYRY A. (MAR)	015 Gankaku #214 / 24.01	3870	(*16) HISAMI N. (JPN)
2	(*16) HISAMI N. (JPN)	068 Papuren	4060	
3	(*31) CHIEN H. (TPE)	001 Anan #215 / 24.01	3970	(*25) MISKOVA V. (CZE)
4	(*25) MISKOVA V. (CZE)	068 Papuren	3940	
5	(*16) HISAMI N. (JPN)	046 Kousukun Sho #218 / 24.01	3970	(*16) HISAMI N. (JPN)
6	(*31) CHIEN H. (TPE)	064 Ohan Dai	3920	
7	(*8) EN-NESYRY A. (MAR)	020 Gojushiho Dai #219 / 24.01	3850	(*25) MISKOVA V. (CZE)
8	(*25) MISKOVA V. (CZE)	092 Suparinpei	4010	
9	(*8) EN-NESYRY A. (MAR)	021 Gojushiho Sho #222 / 24.01	3880	(*31) CHIEN H. (TPE)
10	(*31) CHIEN H. (TPE)	063 Ohan	3930	
11	(*16) HISAMI N. (JPN)	049 Kyan No Chinto #223 / 24.01	3870	(*25) MISKOVA V. (CZE)
12	(*25) MISKOVA V. (CZE)	052 Matsumura Bassai	3950	

1. MISKOVA VERONIKA (CZE)
2. HISAMI NAKAJI (JPN)
3. CHIEN HUI HSUAN (TPE)
4. EN-NESYRY AYA (MAR)

1. ONO MAHO (JPN)
2. LAU MO SHEUNG GRACE (HKG)
3. MISHIMA KIRI (JPN)
3. AZUMA SAEKO (JPN)
5. GARCIA LOZANO PAOLA (ESP)
5. MISKOVA VERONIKA (CZE)
7. SHIMIZU NATSUKI (JPN)
7. KOKUMAI SAKURA (USA)

*Seeded

Referees:			

Female Kata - Round Robin (each against each)

Karate1 Premier League - Paris 2025, Pierre de Coubertin Stadium, Avenue George Lafont 82, 75016 Paris, FRA

Tatami

Pool
8/8



1	(*9) MARQUES R. (POR)	047 Kururunfa #216 / 24.01	3850	(*9) MARQUES R. (POR)
2	(*29) LAOS-LOO C. (CAN)	068 Papuren	3750	
3	(*21) JUETTNER J. (GER)	021 Gojushiho Sho #217 / 24.01	3850	(*1) LAU M. (HKG)
4	(*1) LAU M. (HKG)	068 Papuren	4000	
5	(*29) LAOS-LOO C. (CAN)	065 Oyadomari No Passai #220 / 24.01	3750	(*21) JUETTNER J. (GER)
6	(*21) JUETTNER J. (GER)	092 Suparinpei	3970	
7	(*9) MARQUES R. (POR)	092 Suparinpei #221 / 24.01	3850	(*1) LAU M. (HKG)
8	(*1) LAU M. (HKG)	097 Tomari Bassai	4070	
9	(*9) MARQUES R. (POR)	064 Ohan Dai #224 / 24.01	3750	(*21) JUETTNER J. (GER)
10	(*21) JUETTNER J. (GER)	078 Sansai	4050	
11	(*29) LAOS-LOO C. (CAN)	092 Suparinpei #225 / 24.01	3800	(*1) LAU M. (HKG)
12	(*1) LAU M. (HKG)	009 Chibana No Kushanku	4100	

1. LAU MO SHEUNG GRACE (HKG)
2. JUETTNER JASMIN (GER)
3. MARQUES RITA (POR)
4. LAOS-LOO CLAUDIA (CAN)

1. ONO MAHO (JPN)
2. LAU MO SHEUNG GRACE (HKG)
3. MISHIMA KIRI (JPN)
3. AZUMA SAEKO (JPN)
5. GARCIA LOZANO PAOLA (ESP)
5. MISKOVA VERONIKA (CZE)
7. SHIMIZU NATSUKI (JPN)
7. KOKUMAI SAKURA (USA)

*Seeded

Referees:			

Pool winner-Female Kata

Karate1 Premier League - Paris 2025, Pierre de Coubertin Stadium, Avenue George Lafont 82, 75016 Paris, FRA

Tatami

Pool
1/1

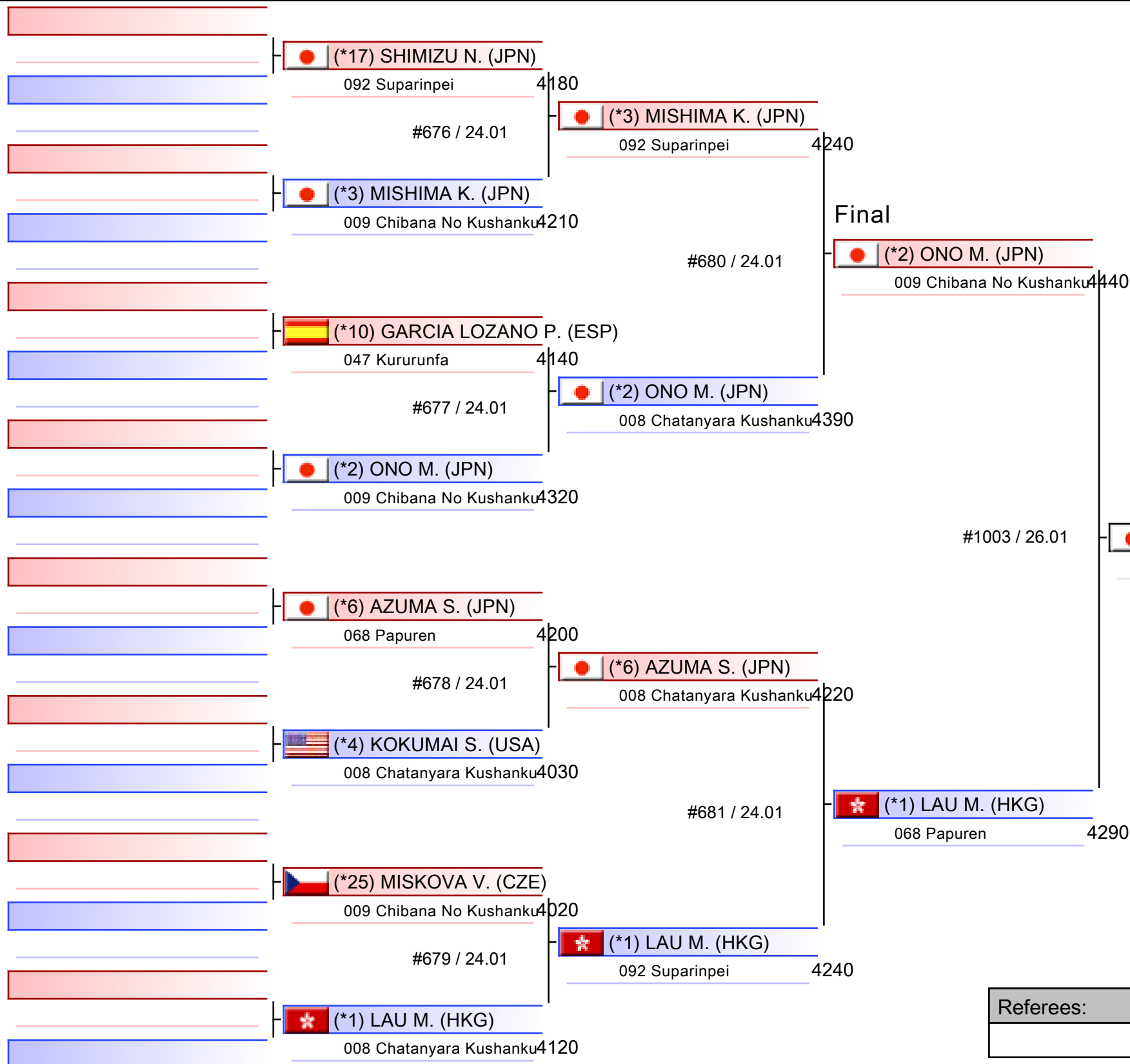

1. ONO MAHO (JPN)
2. LAU MO SHEUNG GRACE (HKG)
3. MISHIMA KIRI (JPN)
3. AZUMA SAEKO (JPN)
5. GARCIA LOZANO PAOLA (ESP)
5. MISKOVA VERONIKA (CZE)
7. SHIMIZU NATSUKI (JPN)
7. KOKUMAI SAKURA (USA)

*Seeded

Referees:			

Female Kata

Karate1 Premier League - Paris 2025

Tatami

Pool
1,2,3,4,5,6,7,8

(c)sportdata GmbH & Co KG 2000-2025 (2025-01-27 23:36) v 10.2.0 build 1 (2025-01-18 23:49 CET) License: SDIL 2025 (expire 2025-12-31)

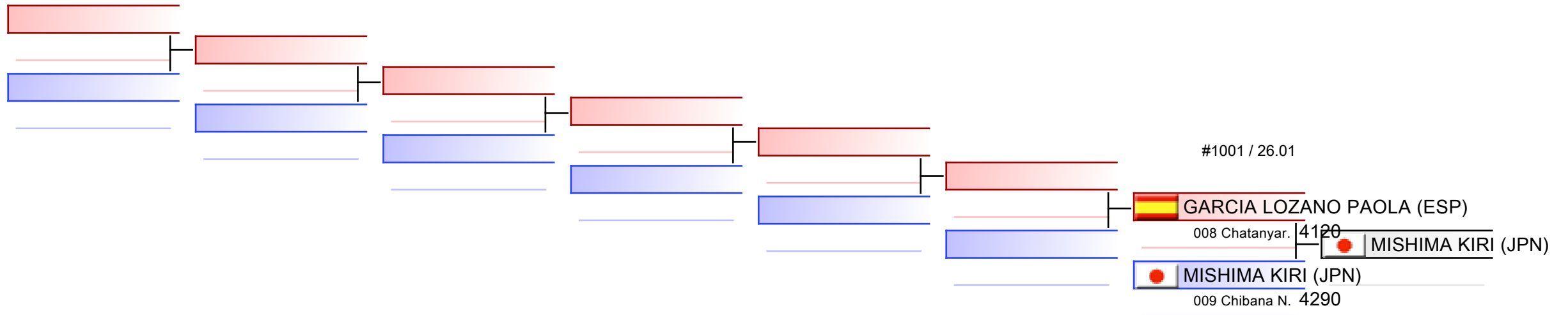

REPECHAGE: (1,2,3,4,5,6,7,8)

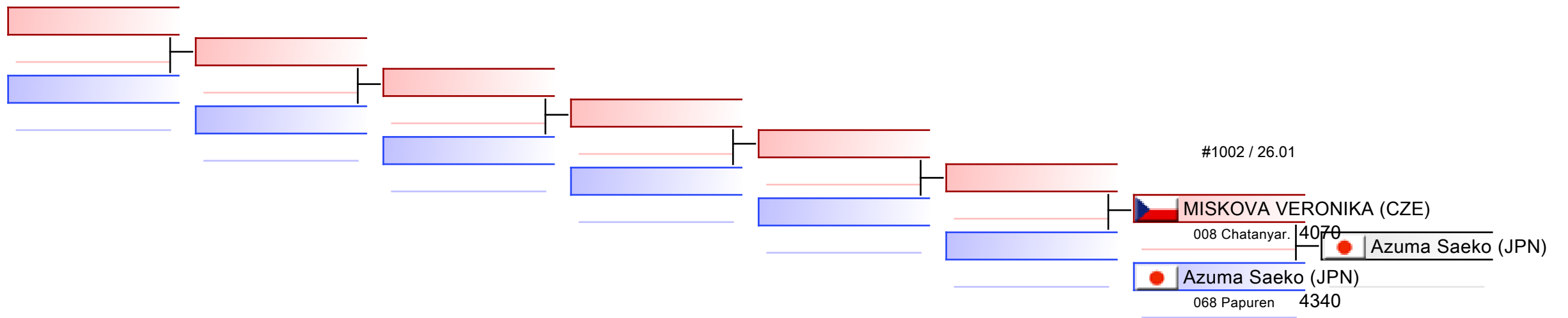

Referees:							
-----------	--	--	--	--	--	--	--

FEMALE KUMITE -50 KG



Karate1 Premier League - Paris 2025

ENTRIES BY WEIGHT CATEGORY



Female Kumite -50 Kg

As of 27 JAN 2025

Country Code	ID	Gender	Name	Seeding
ALG	ALG02678	F	Ouikene Cylia	5
AZE	AZE2028	F	TEYMUROVA FIDAN	20
BUL	BUL2210	F	TSANEVA TEODORA	18
CAN	CAN2249	F	LAHYANSSA YAMINA	9
COL	COL2195	F	CARDENAS BALCAZAR SOFIA	7
CYP	CYP2131	F	KONTOU IRENE	26
EGY	EGY2528	F	Salama Reem Ahmed	3
ESA	ESA2056	F	IZAGUIRRE GABRIELLA	22
ESP	ESP03590	F	RODRIGUEZ LOREDO EVA	28
FRA	FRA2379	F	AHMED Niswa	29
FRA	SD68835	F	BONNARDE Tiphaine	24
FRA	FRA02769	F	BREUZARD CHLOE	17
GER	GER2484	F	Bugur Seden	23
GER	GER2252	F	HUBRICH SHARA	12
IRI	IRI2134	F	BAHMANYAR SARA	30
IRI	SD73925	F	MOHSENIAN MASOUMEH	19
ITA	ITA2512	F	AGUS ASIA	14
ITA	ITA04298	F	COLLETTI EMMA	16
ITA	ITA376	F	Perfetto Erminia	6
JPN	JPN02704	F	OKAZAKI AIKA	15
JPN	JPN03042	F	TSUTSUMI SARA	11
KAZ	KAZ2019	F	ZHANGBYRBAY MOLDIR	2
MAS	MAS02418	F	CHANDRAN SHAHMALARANI	8
NED	NED02464	F	YALCIN Samina	31
POR	POR2187	F	Rodrigues Catarina	10
SVK	SVK2293	F	VARGOVA NATALIA	4
TPE	TPE02416	F	CHAN HSIN-YU	27
TUR	TUR552	F	KUCUKOGLU SELVA NUR AKKURT	21
UAE	UAE2003	F	Alajmi Hawraa	25
UKR	UKR2269	F	PALASHEVSKA YULIIA	13
VEN	VEN297	F	salazar yorgelis	1

Female Kumite -50 Kg - Round Robin (each against each)

Karate1 Premier League - Paris 2025, Pierre de Coubertin Stadium, Avenue George Lafont 82, 75016 Paris, FRA

Tatami

Pool
1/8



1	(*25) ALAJMI H. (UAE)	PTS	#25 / 24.01	1	(*25) ALAJMI H. (UAE)
2	(*10) RODRIGUES C. (POR)	PTS	0		
3	(*16) COLLETTI E. (ITA)	PTS	#26 / 24.01	3	(*22) IZAGUIRRE G. (ESA)
4	(*22) IZAGUIRRE G. (ESA)	PTS	4		
5	(*10) RODRIGUES C. (POR)	PTS	#29 / 24.01	1	(*10) RODRIGUES C. (POR)
6	(*16) COLLETTI E. (ITA)	PTS	0		
7	(*25) ALAJMI H. (UAE)	PTS	#30 / 24.01	0	(*22) IZAGUIRRE G. (ESA)
8	(*22) IZAGUIRRE G. (ESA)	PTS	1		
9	(*25) ALAJMI H. (UAE)	PTS	#33 / 24.01	4	(*25) ALAJMI H. (UAE)
10	(*16) COLLETTI E. (ITA)	PTS	2		
11	(*10) RODRIGUES C. (POR)	PTS	#34 / 24.01	0	(*22) IZAGUIRRE G. (ESA)
12	(*22) IZAGUIRRE G. (ESA)	PTS	3		

1. IZAGUIRRE GABRIELLA (ESA)
2. ALAJMI HAWRAA (UAE)
3. RODRIGUES CATARINA (POR)
4. COLLETTI EMMA (ITA)

1. BAHMANYAR SARA (IRI)
2. MOHSENIAN MASOUMEH (IRI)
3. ZHANGBYRBAY MOLDIR (KAZ)
3. SALAZAR YORGELIS (VEN)
5. OKAZAKI AIKA (JPN)
5. VARGOVA NATALIA (SVK)
7. IZAGUIRRE GABRIELLA (ESA)
7. CHANDRAN SHAHMALARANI (MAS)

*Seeded

Referees:			

Female Kumite -50 Kg - Round Robin (each against each)

Karate1 Premier League - Paris 2025, Pierre de Coubertin Stadium, Avenue George Lafont 82, 75016 Paris, FRA

Tatami

Pool
2/8



1	(*29) AHMED N. (FRA)	
	#27 / 24.01	3
2	(*12) HUBRICH S. (GER)	
	SEN	3
	PTS	
3	(*15) OKAZAKI A. (JPN)	
	#28 / 24.01	4
4	(*3) SALAMA R. (EGY)	
		1
5	(*12) HUBRICH S. (GER)	
	#31 / 24.01	0
	PTS	
6	(*15) OKAZAKI A. (JPN)	
		1
	SEN	
7	(*29) AHMED N. (FRA)	
	#32 / 24.01	1
8	(*3) SALAMA R. (EGY)	
		1
9	(*29) AHMED N. (FRA)	
	#35 / 24.01	3
	PTS	
10	(*15) OKAZAKI A. (JPN)	
		5
11	(*12) HUBRICH S. (GER)	
	#36 / 24.01	0
12	(*3) SALAMA R. (EGY)	
		0

1. OKAZAKI AIKA (JPN)
2. HUBRICH SHARA (GER)
3. AHMED NISWA (FRA)
4. SALAMA REEM AHMED (EGY)

1. BAHMANYAR SARA (IRI)
2. MOHSENIAN MASOUMEH (IRI)
3. ZHANGBYRBAY MOLDIR (KAZ)
3. SALAZAR YORGELIS (VEN)
5. OKAZAKI AIKA (JPN)
5. VARGOVA NATALIA (SVK)
7. IZAGUIRRE GABRIELLA (ESA)
7. CHANDRAN SHAHMALARANI (MAS)

*Seeded

Referees:			

Female Kumite -50 Kg - Round Robin (each against each)

Karate1 Premier League - Paris 2025, Pierre de Coubertin Stadium, Avenue George Lafont 82, 75016 Paris, FRA

Tatami

Pool
3/8



1	(*6) PERFETTO E. (ITA)	3	(*6) PERFETTO E. (ITA)
	#97 / 24.01		
2	(*31) YALCIN S. (NED)	0	
3	(*26) KONTOU I. (CYP)	2	(*30) BAHMANYAR S. (IRI)
	#98 / 24.01		
4	(*30) BAHMANYAR S. (IRI)	6	
5	(*31) YALCIN S. (NED)	1	(*26) KONTOU I. (CYP)
	#101 / 24.01		
6	(*26) KONTOU I. (CYP)	4	
7	(*6) PERFETTO E. (ITA)	2	(*30) BAHMANYAR S. (IRI)
	#102 / 24.01		
8	(*30) BAHMANYAR S. (IRI)	4	
	PTS		
9	(*6) PERFETTO E. (ITA)	5	(*6) PERFETTO E. (ITA)
	#105 / 24.01		
10	(*26) KONTOU I. (CYP)	1	
11	(*31) YALCIN S. (NED)	2	(*30) BAHMANYAR S. (IRI)
	#106 / 24.01		
12	(*30) BAHMANYAR S. (IRI)	3	

1. BAHMANYAR SARA (IRI)
2. PERFETTO ERMINIA (ITA)
3. KONTOU IRENE (CYP)
4. YALCIN SAMINA (NED)

1. BAHMANYAR SARA (IRI)
2. MOHSENIAN MASOUMEH (IRI)
3. ZHANGBYRBAY MOLDIR (KAZ)
3. SALAZAR YORGELIS (VEN)
5. OKAZAKI AIKA (JPN)
5. VARGOVA NATALIA (SVK)
7. IZAGUIRRE GABRIELLA (ESA)
7. CHANDRAN SHAHMALARANI (MAS)

*Seeded

Referees:			

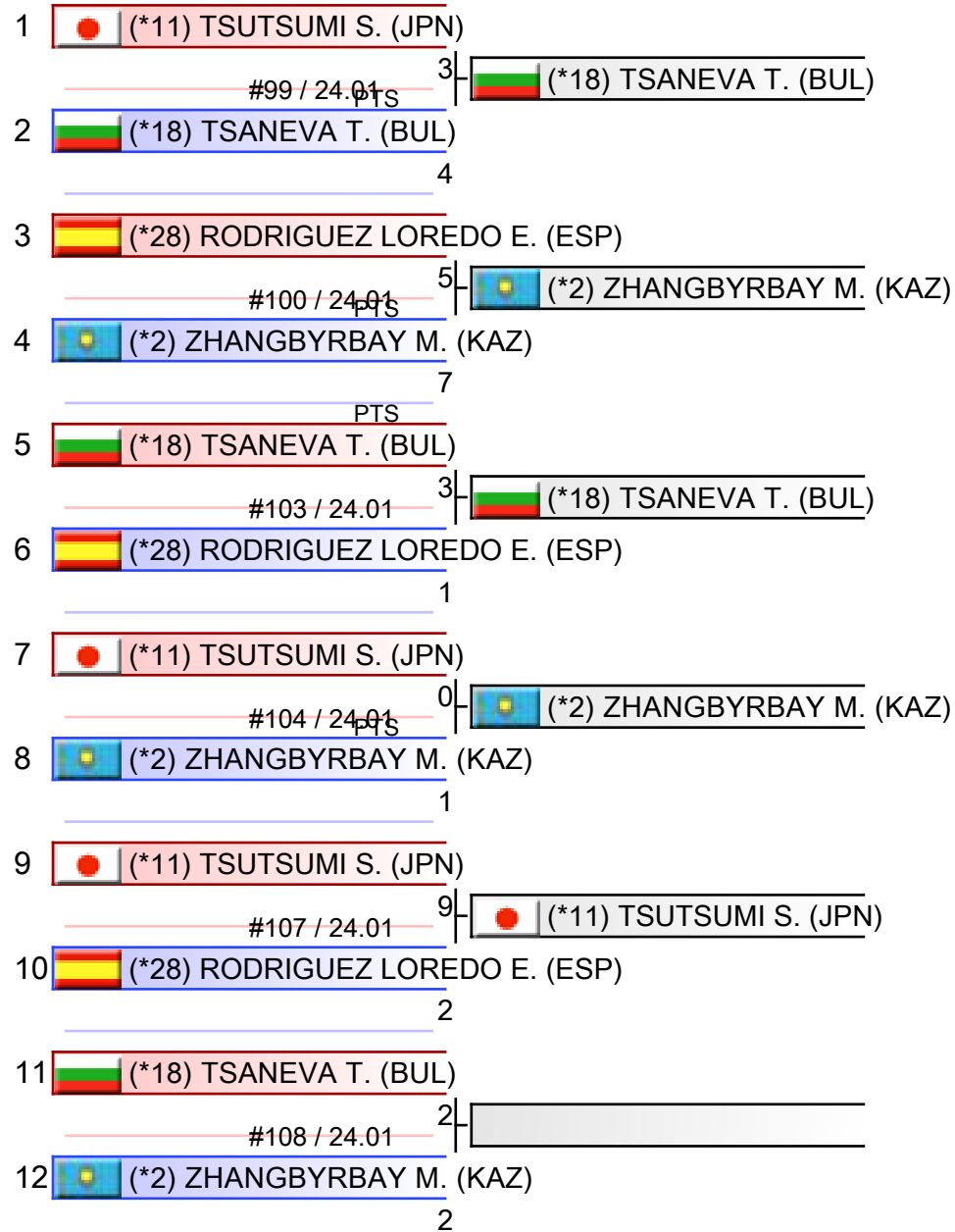

- ZHANGBYRBAY MOLDIR (KAZ)
- TSANEVA TEODORA (BUL)
- TSUTSUMI SARA (JPN)
- RODRIGUEZ LOREDO EVA (ESP)

1. BAHMANYAR SARA (IRI)
2. MOHSENIAN MASOUMEH (IRI)
3. ZHANGBYRBAY MOLDIR (KAZ)
3. SALAZAR YORGELIS (VEN)
5. OKAZAKI AIKA (JPN)
5. VARGOVA NATALIA (SVK)
7. IZAGUIRRE GABRIELLA (ESA)
7. CHANDRAN SHAHMALARANI (MAS)

*Seeded

Referees:			

Female Kumite -50 Kg - Round Robin (each against each)

Karate1 Premier League - Paris 2025, Pierre de Coubertin Stadium, Avenue George Lafont 82, 75016 Paris, FRA

Tatami

Pool
5/8



1	(*5) OUIKENE C. (ALG)	#166 / 24.01	3	(*5) OUIKENE C. (ALG)
2	(*24) BONNARDE T. (FRA)		1	
3	(*13) PALASHEVSKA Y. (UKR)	#167 / 24.01	1	(*8) CHANDRAN S. (MAS)
4	(*8) CHANDRAN S. (MAS)		2	
5	(*24) BONNARDE T. (FRA)	#170 / 24.01	0	(*13) PALASHEVSKA Y. (UKR)
6	(*13) PALASHEVSKA Y. (UKR)		6	
7	(*5) OUIKENE C. (ALG)	#171 / 24.01	0	(*8) CHANDRAN S. (MAS)
8	(*8) CHANDRAN S. (MAS)		5	
9	(*5) OUIKENE C. (ALG)	#174 / 24.01	5	(*5) OUIKENE C. (ALG)
10	(*13) PALASHEVSKA Y. (UKR)		2	
11	(*24) BONNARDE T. (FRA)	#175 / 24.01	3	(*8) CHANDRAN S. (MAS)
12	(*8) CHANDRAN S. (MAS)		3	

1. CHANDRAN SHAHMALARANI (MAS)
2. OUIKENE CYLIA (ALG)
3. PALASHEVSKA YULIYA (UKR)
4. BONNARDE TIPHAINE (FRA)

1. BAHMANYAR SARA (IRI)
2. MOHSENIAN MASOUMEH (IRI)
3. ZHANGBYRBAY MOLDIR (KAZ)
3. SALAZAR YORGELIS (VEN)
5. OKAZAKI AIKA (JPN)
5. VARGOVA NATALIA (SVK)
7. IZAGUIRRE GABRIELLA (ESA)
7. CHANDRAN SHAHMALARANI (MAS)

*Seeded

Referees:			



1	(*23) BUGUR S. (GER)	#168 / 24-015	1	(*20) TEYMUROVA F. (AZE)
2	(*20) TEYMUROVA F. (AZE)		3	
3	(*17) BREUZARD C. (FRA)	#169 / 24-015	2	(*4) VARGOVA N. (SVK)
4	(*4) VARGOVA N. (SVK)		3	
5	(*20) TEYMUROVA F. (AZE)	#172 / 24-015	2	(*17) BREUZARD C. (FRA)
6	(*17) BREUZARD C. (FRA)		5	
7	(*23) BUGUR S. (GER)	#173 / 24-015	4	(*4) VARGOVA N. (SVK)
8	(*4) VARGOVA N. (SVK)		5	
9	(*23) BUGUR S. (GER)	#176 / 24-015	0	(*17) BREUZARD C. (FRA)
10	(*17) BREUZARD C. (FRA)		2	
11	(*20) TEYMUROVA F. (AZE)	#177 / 24-015	0	(*4) VARGOVA N. (SVK)
12	(*4) VARGOVA N. (SVK)		7	

1. VARGOVA NATALIA (SVK)
2. BREUZARD CHLOE (FRA)
3. TEYMUROVA FIDAN (AZE)
4. BUGUR SEDEN (GER)

1. BAHMANYAR SARA (IRI)
2. MOHSENIAN MASOUMEH (IRI)
3. ZHANGBYRBAY MOLDIR (KAZ)
3. SALAZAR YORGELIS (VEN)
5. OKAZAKI AIKA (JPN)
5. VARGOVA NATALIA (SVK)
7. IZAGUIRRE GABRIELLA (ESA)
7. CHANDRAN SHAHMALARANI (MAS)

*Seeded

Referees:			

Female Kumite -50 Kg - Round Robin (each against each)

Karate1 Premier League - Paris 2025, Pierre de Coubertin Stadium, Avenue George Lafont 82, 75016 Paris, FRA

Tatami

Pool
7/8



1	(*9) LAHYANSSA Y. (CAN)	#235 / 24.01	0	(*19) MOHSENIAN M. (IRI)
2	(*19) MOHSENIAN M. (IRI)		1	
3	(*14) AGUS A. (ITA)	#236 / 24.01	0	(*21) KUCUKOGLU S. (TUR)
4	(*21) KUCUKOGLU S. (TUR)		3	
5	(*19) MOHSENIAN M. (IRI)	#238 / 24.01	2	(*14) AGUS A. (ITA)
6	(*14) AGUS A. (ITA)		3	
7	(*9) LAHYANSSA Y. (CAN)	#239 / 24.01	2	(*21) KUCUKOGLU S. (TUR)
8	(*21) KUCUKOGLU S. (TUR)		2	
9	(*9) LAHYANSSA Y. (CAN)	#241 / 24.01	3	(*14) AGUS A. (ITA)
10	(*14) AGUS A. (ITA)		4	
11	(*19) MOHSENIAN M. (IRI)	#242 / 24.01	5	(*19) MOHSENIAN M. (IRI)
12	(*21) KUCUKOGLU S. (TUR)		2	

1. MOHSENIAN MASOUMEH (IRI)
2. KUCUKOGLU SELVA NUR AKKURT (TUR)
3. AGUS ASIA (ITA)
4. LAHYANSSA YAMINA (CAN)

1. BAHMANYAR SARA (IRI)
2. MOHSENIAN MASOUMEH (IRI)
3. ZHANGBYRBAY MOLDIR (KAZ)
3. SALAZAR YORGELIS (VEN)
5. OKAZAKI AIKA (JPN)
5. VARGOVA NATALIA (SVK)
7. IZAGUIRRE GABRIELLA (ESA)
7. CHANDRAN SHAHMALARANI (MAS)

*Seeded

Referees:			

Female Kumite -50 Kg - Round Robin (each against each)

Karate1 Premier League - Paris 2025, Pierre de Coubertin Stadium, Avenue George Lafont 82, 75016 Paris, FRA

Tatami

Pool
8/8



1	(*27) CHAN H. (TPE)	2	(*7) CARDENAS BALCAZAR S. (COL)
	#237 / 24-01		
2	(*7) CARDENAS BALCAZAR S. (COL)	4	
3	(*27) CHAN H. (TPE)	0	(*1) SALAZAR Y. (VEN)
	#243 / 24-01		
4	(*1) SALAZAR Y. (VEN)	1	
5	(*7) CARDENAS BALCAZAR S. (COL)	2	(*1) SALAZAR Y. (VEN)
	#240 / 24-01		
6	(*1) SALAZAR Y. (VEN)	6	

1. SALAZAR YORGELIS (VEN)
2. CARDENAS BALCAZAR SOFIA (COL)
3. CHAN HSIN-YU (TPE)

1. BAHMANYAR SARA (IRI)
2. MOHSENIAN MASOUMEH (IRI)
3. ZHANGBYRBAY MOLDIR (KAZ)
3. SALAZAR YORGELIS (VEN)
5. OKAZAKI AIKA (JPN)
5. VARGOVA NATALIA (SVK)
7. IZAGUIRRE GABRIELLA (ESA)
7. CHANDRAN SHAHMALARANI (MAS)

*Seeded

Referees:			

Pool winner-Female Kumite -50 Kg

Karate1 Premier League - Paris 2025, Pierre de Coubertin Stadium, Avenue George Lafont 82, 75016 Paris, FRA

Tatami

Pool
1/1

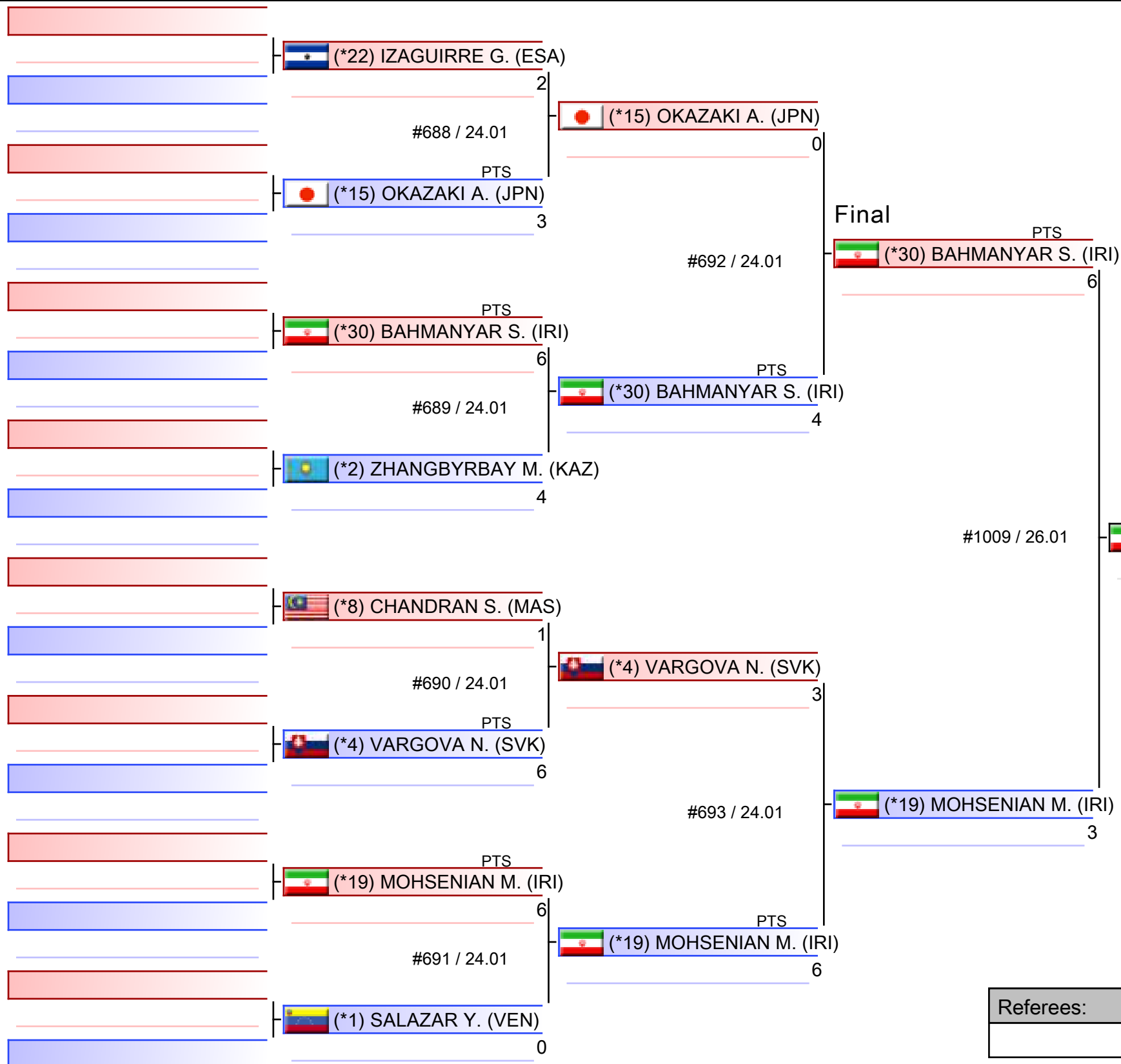

1. BAHMANYAR SARA (IRI)
2. MOHSENIAN MASOUMEH (IRI)
3. ZHANGBYRBAY MOLDIR (KAZ)
3. SALAZAR YORGELIS (VEN)
5. OKAZAKI AIKA (JPN)
5. VARGOVA NATALIA (SVK)
7. IZAGUIRRE GABRIELLA (ESA)
7. CHANDRAN SHAHMALARANI (MAS)

*Seeded

Referees:			

Female Kumite -50 Kg

Karate1 Premier League - Paris 2025

Tatami

Pool
1,2,3,4,5,6,7,8

(c)sportdata GmbH & Co KG 2000-2025 (2025-01-27 23:36) v 10.2.0 build 1 (2025-01-18 23:49 CET) License: SDIL 2025 (expire 2025-12-31)

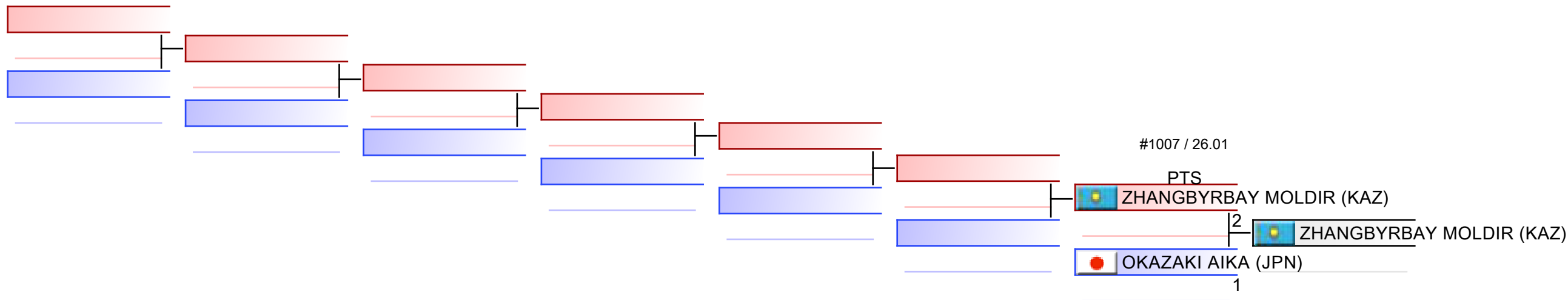

REPECHAGE: (1,2,3,4,5,6,7,8)

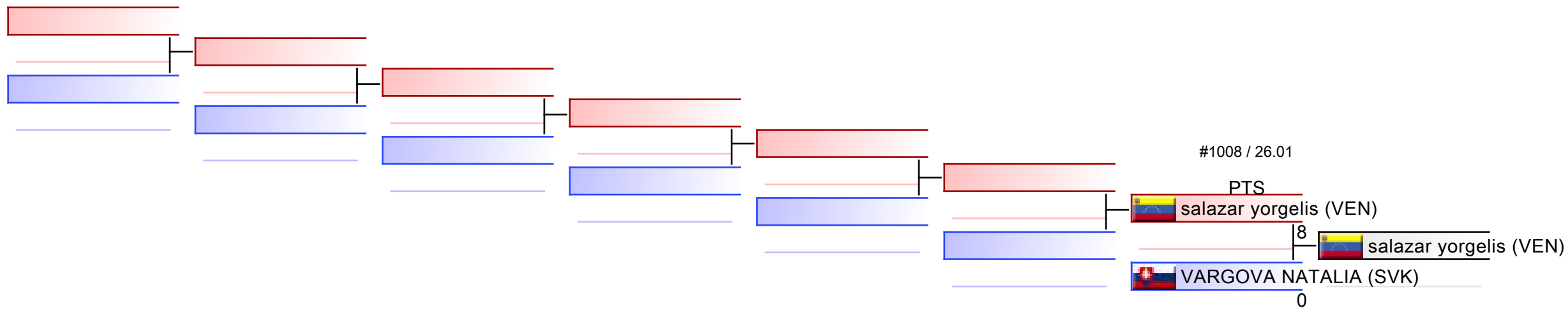

Referees:							
-----------	--	--	--	--	--	--	--

FEMALE KUMITE -55 KG



Karate1 Premier League - Paris 2025

ENTRIES BY WEIGHT CATEGORY



Female Kumite -55 Kg

As of 27 JAN 2025

Country Code	ID	Gender	Name	Seeding
ALG	ALG02679	F	ABOURICHE LOUIZA	4
BIH	BIH2111	F	SIPOVIC NEJRA	30
BUL	BUL304	F	GORANOVA IVET	27
CAN	CAN245	F	FURUMOTO-DESHAIES HANA	6
CHI	CHI2015	F	TORO MENESES VALENTINA	1
CRO	CRO404	F	HASANI ALESSANDRA	26
EGY	EGY2630	F	YOUSSEF AHLAM	10
ESP	ESP2197	F	LORENZO COUSO RUTH	31
ESP	ESP2263	F	PEREIRA VILLALOBOS SONIA	25
FRA	FRA03633	F	ABDESSELEM Silya	21
GER	GER2519	F	BITSCH MIA	2
GER	GER2084	F	BUGUR GIZEM	28
GRE	GRE2076	F	Stoli Maria	3
INA	INA2001	F	AGUNG SANISTYARANI COK ISTRI	12
IRI	IRI212	F	Khaksar Taravat	29
ITA	ITA2132	F	BRUNORI VERONICA	13
ITA	ITA395	F	Lallo viola	8
ITA	ITA2401	F	Mancinelli Syria	16
JPN	SD77050	F	KODO RINA	15
JPN	JPN2072	F	SHIMA AIRI	5
KAZ	KAZ66e2ee6e1e9d6	F	USSENOVA GULMIRA	11
LAT	LAT2021	F	MUIZNIECE MARIJA LUIZE	22
LUX	LUX124	F	WARLING JENNIFER	14
POL	POL08881	F	DRONCHANKA KSENIYA	19
SCO	SCO171	F	Connell Amy	32
SUI	SUI267	F	SCHAERER MAYA	23
SWE	SWE2151	F	ROSENLIND MATILDA	17
TPE	TPE159	F	KU TSUI-PING	7
TUR	TUR03944	F	IM ZUMRA REZZAN	20
TUR	TUR2023	F	YAKAN TUBA	9
USA	USA2034	F	ALLEN TRINITY	18
VEN	VEN2096	F	Perez Barbara	24



1	(*25) PEREIRA VILLALOBOS S. (ESP)	#49 / 24.01	0
2	(*22) MUIZNIECE M. (LAT)		0
3	(*32) CONNELL A. (SCO)	#50 / 24.01	1
4	(*10) YOUSSEF A. (EGY)		2
5	(*22) MUIZNIECE M. (LAT)	#53 / 24.01	1
6	(*32) CONNELL A. (SCO)		0
7	(*25) PEREIRA VILLALOBOS S. (ESP)	#54 / 24.01	0
8	(*10) YOUSSEF A. (EGY)		7
9	(*25) PEREIRA VILLALOBOS S. (ESP)	#57 / 24.01	3
10	(*32) CONNELL A. (SCO)		2
11	(*22) MUIZNIECE M. (LAT)	#58 / 24.01	2
12	(*10) YOUSSEF A. (EGY)		3

1. YOUSSEF AHLAM (EGY)
2. MUIZNIECE MARIJA LUIZE (LAT)
3. PEREIRA VILLALOBOS SONIA (ESP)
4. CONNELL AMY (SCO)

1. YOUSSEF AHLAM (EGY)
2. FURUMOTO-DESHAIES HANA (CAN)
3. YAKAN TUBA (TUR)
3. ALLEN TRINITY (USA)
5. STOLI MARIA (GRE)
5. KODO RINA (JPN)
7. AGUNG SANISTYARANI COK ISTRY (INA)
7. GORANOVA IVET (BUL)

*Seeded

Referees:			

Female Kumite -55 Kg - Round Robin (each against each)

Karate1 Premier League - Paris 2025, Pierre de Coubertin Stadium, Avenue George Lafont 82, 75016 Paris, FRA

Tatami

Pool
2/8

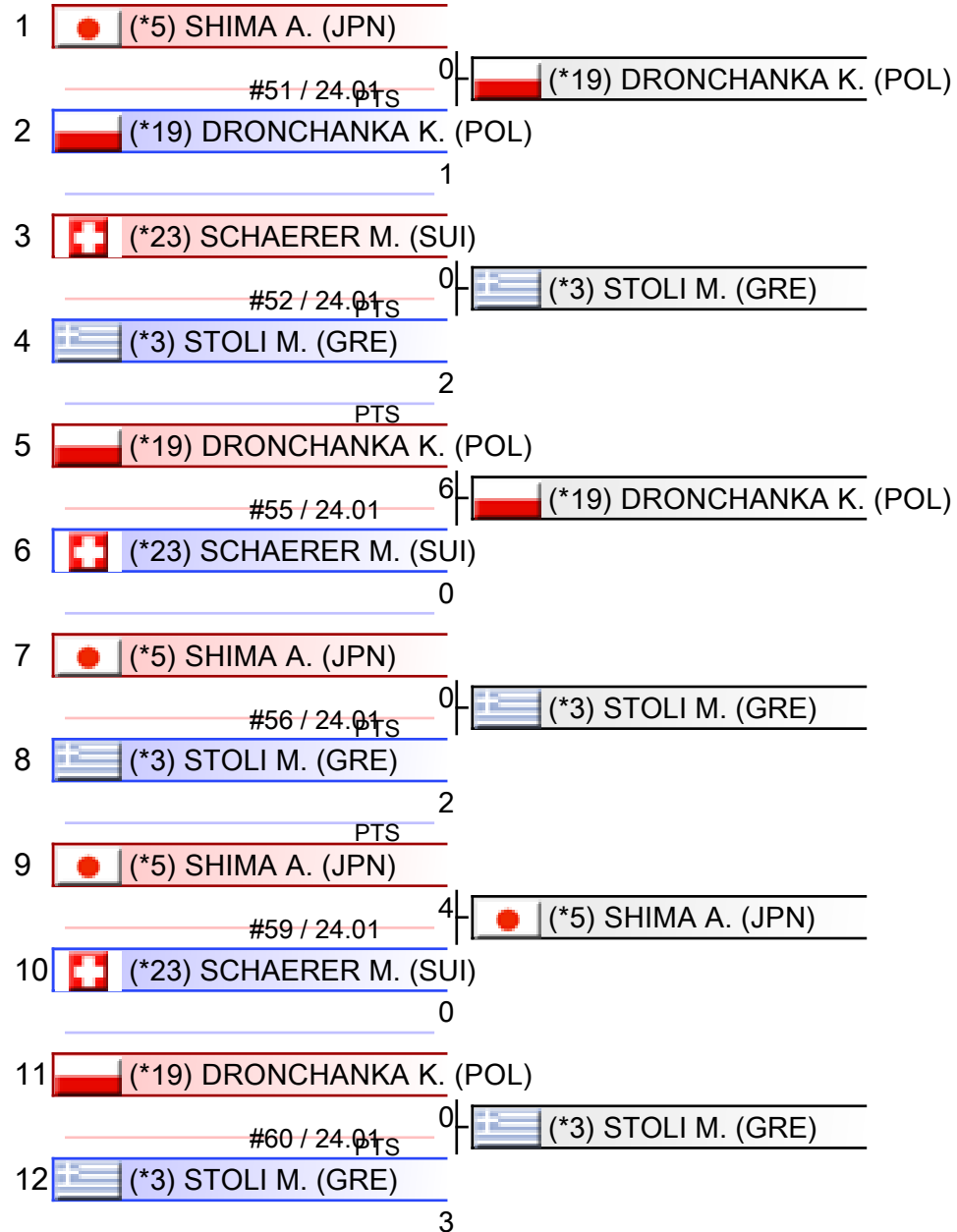

1. STOLI MARIA (GRE)
2. DRONCHANKA KSENIYA (POL)
3. SHIMA AIRI (JPN)
4. SCHAEERER MAYA (SUI)

1. YOUSSEF AHLAM (EGY)
2. FURUMOTO-DESHAIES HANA (CAN)
3. YAKAN TUBA (TUR)
3. ALLEN TRINITY (USA)
5. STOLI MARIA (GRE)
5. KODO RINA (JPN)
7. AGUNG SANISTYARANI COK ISTRY (INA)
7. GORANOVA IVET (BUL)

*Seeded

Referees:			

Female Kumite -55 Kg - Round Robin (each against each)

Karate1 Premier League - Paris 2025, Pierre de Coubertin Stadium, Avenue George Lafont 82, 75016 Paris, FRA

Tatami

Pool
3/8



1	(*26) HASANI A. (CRO)	#118 / 24.01	1	(*11) USSENOVA G. (KAZ)
2	(*11) USSENOVA G. (KAZ)		4	
3	(*28) BUGUR G. (GER)	#119 / 24.01	0	(*9) YAKAN T. (TUR)
4	(*9) YAKAN T. (TUR)		3	
5	(*11) USSENOVA G. (KAZ)	#122 / 24.01	5	(*11) USSENOVA G. (KAZ)
6	(*28) BUGUR G. (GER)		0	
7	(*26) HASANI A. (CRO)	#123 / 24.01	1	(*9) YAKAN T. (TUR)
8	(*9) YAKAN T. (TUR)		5	
9	(*26) HASANI A. (CRO)	#126 / 24.01	2	(*28) BUGUR G. (GER)
10	(*28) BUGUR G. (GER)		3	
11	(*11) USSENOVA G. (KAZ)	#127 / 24.01	2	(*9) YAKAN T. (TUR)
12	(*9) YAKAN T. (TUR)		10	

1. YAKAN TUBA (TUR)
2. USSENOVA GULMIRA (KAZ)
3. BUGUR GIZEM (GER)
4. HASANI ALESSANDRA (CRO)

1. YOUSSEF AHLAM (EGY)
2. FURUMOTO-DESHAIES HANA (CAN)
3. YAKAN TUBA (TUR)
3. ALLEN TRINITY (USA)
5. STOLI MARIA (GRE)
5. KODO RINA (JPN)
7. AGUNG SANISTYARANI COK ISTRY (INA)
7. GORANOVA IVET (BUL)

*Seeded

Referees:			

Female Kumite -55 Kg - Round Robin (each against each)

Karate1 Premier League - Paris 2025, Pierre de Coubertin Stadium, Avenue George Lafont 82, 75016 Paris, FRA

Tatami

Pool
4/8



1	(*29) KHAKSAR T. (IRI)	3	(*29) KHAKSAR T. (IRI)
	#120 / 24.01		
2	(*24) PEREZ B. (VEN)	2	
	PTS		
3	(*12) AGUNG SANISTYARANI C. (INA)	1	(*12) AGUNG SANISTYARANI C. (INA)
	#121 / 24.01		
4	(*2) BITSCH M. (GER)	8	
5	(*24) PEREZ B. (VEN)	0	(*12) AGUNG SANISTYARANI C. (INA)
	#124 / 24.01		
6	(*12) AGUNG SANISTYARANI C. (INA)	3	
	PTS		
7	(*29) KHAKSAR T. (IRI)	0	(*2) BITSCH M. (GER)
	#125 / 24.01		
8	(*2) BITSCH M. (GER)	6	
9	(*29) KHAKSAR T. (IRI)	5	(*12) AGUNG SANISTYARANI C. (INA)
	#128 / 24.01		
10	(*12) AGUNG SANISTYARANI C. (INA)	7	
	PTS		
11	(*24) PEREZ B. (VEN)	0	(*2) BITSCH M. (GER)
	#129 / 24.01		
12	(*2) BITSCH M. (GER)	1	

1. AGUNG SANISTYARANI COK ISTRI (INA)
2. BITSCH MIA (GER)
3. KHAKSAR TARAVAT (IRI)
4. PEREZ BARBARA (VEN)

1. YOUSSEF AHLAM (EGY)
2. FURUMOTO-DESHAIES HANA (CAN)
3. YAKAN TUBA (TUR)
3. ALLEN TRINITY (USA)
5. STOLI MARIA (GRE)
5. KODO RINA (JPN)
7. AGUNG SANISTYARANI COK ISTRI (INA)
7. GORANOVA IVET (BUL)

*Seeded

Referees:			

Female Kumite -55 Kg - Round Robin (each against each)

Karate1 Premier League - Paris 2025, Pierre de Coubertin Stadium, Avenue George Lafont 82, 75016 Paris, FRA

Tatami

Pool

5/8

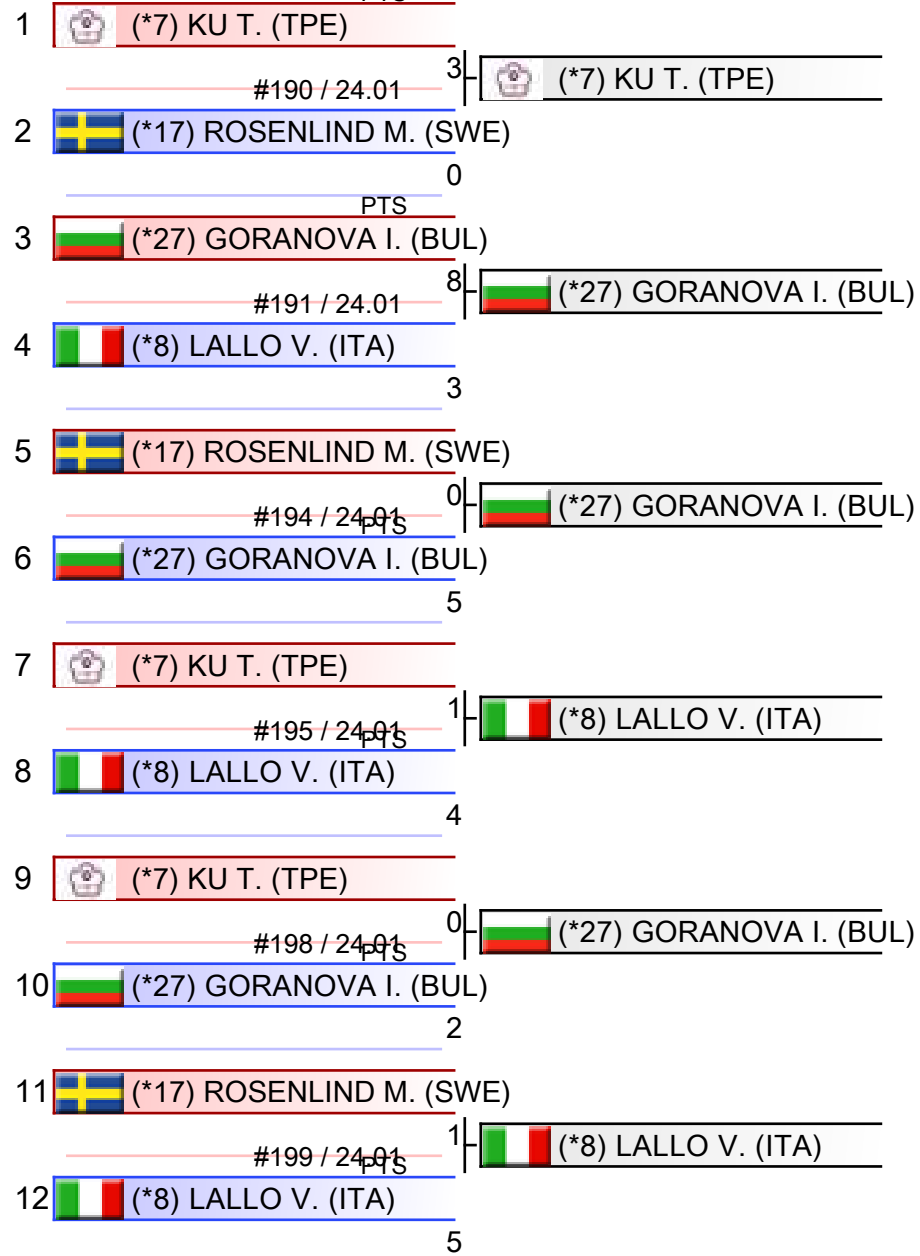

1. GORANOVA IVET (BUL)
2. LALLO VIOLA (ITA)
3. KU TSUI-PING (TPE)
4. ROSENLIND MATILDA (SWE)

1. YOUSSEF AHLAM (EGY)
2. FURUMOTO-DESHAIES HANA (CAN)
3. YAKAN TUBA (TUR)
3. ALLEN TRINITY (USA)
5. STOLI MARIA (GRE)
5. KODO RINA (JPN)
7. AGUNG SANISTYARANI COK ISTRY (INA)
7. GORANOVA IVET (BUL)

*Seeded

Referees:			

Female Kumite -55 Kg - Round Robin (each against each)

Karate1 Premier League - Paris 2025, Pierre de Coubertin Stadium, Avenue George Lafont 82, 75016 Paris, FRA

Tatami

Pool
6/8



1	(*18) ALLEN T. (USA)	
	#192 / 24.01	2 (*18) ALLEN T. (USA)
2	(*13) BRUNORI V. (ITA)	1
3	(*30) SIPOVIC N. (BIH)	0 (*4) ABOURICHE L. (ALG)
	#193 / 24.01	
4	(*4) ABOURICHE L. (ALG)	2
5	(*13) BRUNORI V. (ITA)	0 (*30) SIPOVIC N. (BIH)
	#196 / 24.01	
6	(*30) SIPOVIC N. (BIH)	3
7	(*18) ALLEN T. (USA)	0
	#197 / 24.01	
8	(*4) ABOURICHE L. (ALG)	0
	PTS	
9	(*18) ALLEN T. (USA)	7 (*18) ALLEN T. (USA)
	#200 / 24.01	
10	(*30) SIPOVIC N. (BIH)	0
11	(*13) BRUNORI V. (ITA)	4 (*4) ABOURICHE L. (ALG)
	#201 / 24.01	
12	(*4) ABOURICHE L. (ALG)	5

1. ALLEN TRINITY (USA)
2. ABOURICHE LOUIZA (ALG)
3. SIPOVIC NEJRA (BIH)
4. BRUNORI VERONICA (ITA)

1. YOUSSEF AHLAM (EGY)
2. FURUMOTO-DESHAIES HANA (CAN)
3. YAKAN TUBA (TUR)
3. ALLEN TRINITY (USA)
5. STOLI MARIA (GRE)
5. KODO RINA (JPN)
7. AGUNG SANISTYARANI COK ISTRY (INA)
7. GORANOVA IVET (BUL)

*Seeded

Referees:			

Female Kumite -55 Kg - Round Robin (each against each)

Karate1 Premier League - Paris 2025, Pierre de Coubertin Stadium, Avenue George Lafont 82, 75016 Paris, FRA

Tatami

Pool
7/8



1. KODO RINA (JPN)
2. ABDESSELEM SILYA (FRA)
3. WARLING JENNIFER (LUX)
4. LORENZO COUSO RUTH (ESP)

1. YOUSSEF AHLAM (EGY)
2. FURUMOTO-DESHAIES HANA (CAN)
3. YAKAN TUBA (TUR)
3. ALLEN TRINITY (USA)
5. STOLI MARIA (GRE)
5. KODO RINA (JPN)
7. AGUNG SANISTYARANI COK ISTRY (INA)
7. GORANOVA IVET (BUL)

*Seeded

Referees:			

Female Kumite -55 Kg - Round Robin (each against each)

Karate1 Premier League - Paris 2025, Pierre de Coubertin Stadium, Avenue George Lafont 82, 75016 Paris, FRA

Tatami

Pool

8/8



1	(*16) MANCINELLI S. (ITA)	#255 / 24.01	0	(*20) IM Z. (TUR)
2	(*20) IM Z. (TUR)		3	
3	(*6) FURUMOTO-DESHAIES H. (CAN)	#256 / 24.01	1	
4	(*1) TORO MENESES V. (CHI)		1	
5	(*20) IM Z. (TUR)	#259 / 24.01	0	(*6) FURUMOTO-DESHAIES H. (CAN)
6	(*6) FURUMOTO-DESHAIES H. (CAN)		5	
7	(*16) MANCINELLI S. (ITA)	#260 / 24.01	1	(*1) TORO MENESES V. (CHI)
8	(*1) TORO MENESES V. (CHI)		2	
9	(*16) MANCINELLI S. (ITA)	#263 / 24.01	1	(*6) FURUMOTO-DESHAIES H. (CAN)
10	(*6) FURUMOTO-DESHAIES H. (CAN)		6	
11	(*20) IM Z. (TUR)	#264 / 24.01	2	(*20) IM Z. (TUR)
12	(*1) TORO MENESES V. (CHI)		0	

1. FURUMOTO-DESHAIES HANA (CAN)
2. IM ZUMRA REZZAN (TUR)
3. TORO MENESES VALENTINA (CHI)
4. MANCINELLI SYRIA (ITA)

1. YOUSSEF AHLAM (EGY)
2. FURUMOTO-DESHAIES HANA (CAN)
3. YAKAN TUBA (TUR)
3. ALLEN TRINITY (USA)
5. STOLI MARIA (GRE)
5. KODO RINA (JPN)
7. AGUNG SANISTYARANI COK ISTRY (INA)
7. GORANOVA IVET (BUL)

*Seeded

Referees:			

Pool winner-Female Kumite -55 Kg

Karate1 Premier League - Paris 2025, Pierre de Coubertin Stadium, Avenue George Lafont 82, 75016 Paris, FRA

Tatami

Pool
1/1

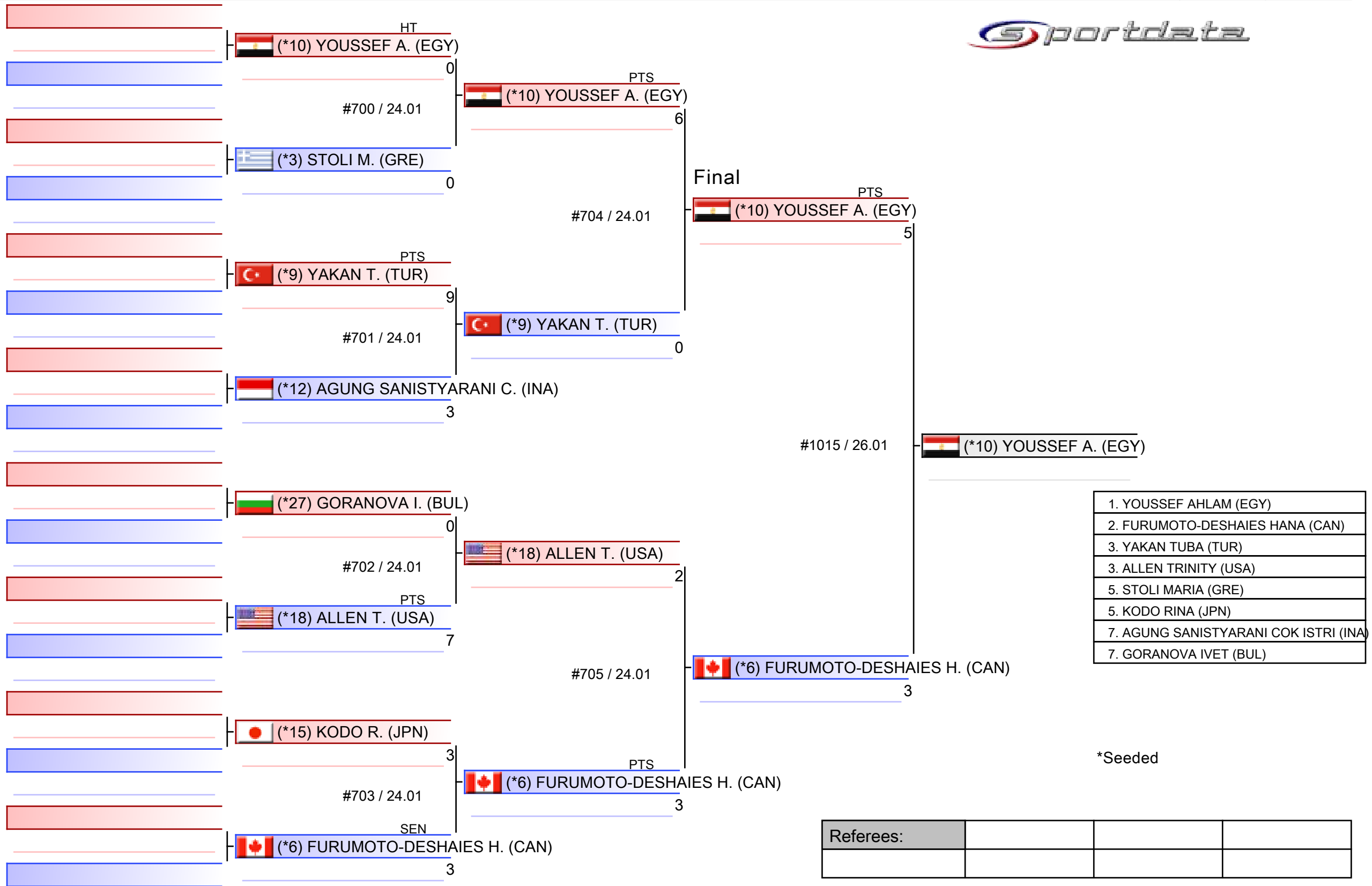

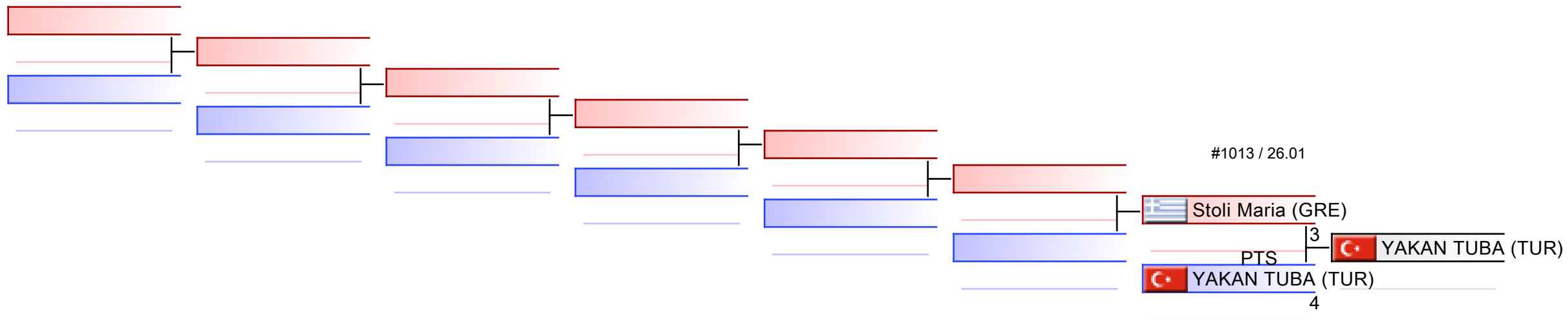

REPECHAGE: (1,2,3,4,5,6,7,8)

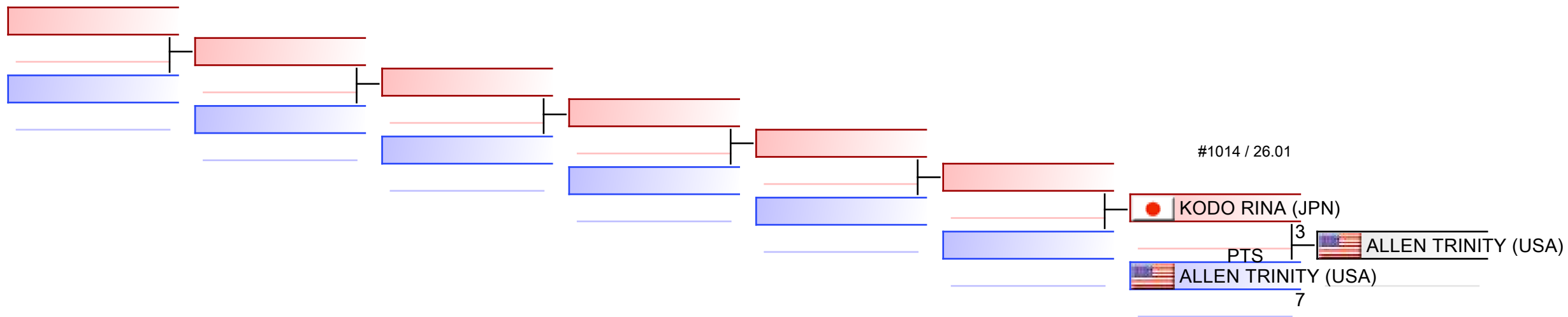

Referees:							
-----------	--	--	--	--	--	--	--

FEMALE KUMITE -61 KG



Karate1 Premier League - Paris 2025

ENTRIES BY WEIGHT CATEGORY



Female Kumite -61 Kg

As of 27 JAN 2025

Country Code	ID	Gender	Name	Seeding
AUT	AUT2066	F	TOPALOVIC LEJLA	10
BEL	BEL02934	F	AJARAY MARYAM	2
BIH	BIH2110	F	Sipovic Emina	24
BRA	BRA2042	F	RODRIGUES BARBARA	26
CHI	CHI2361	F	HUAIQUIMAN BARBARA	29
CRO	CRO2627	F	CACKO MIA	27
ECU	ECU128	F	FACTOS JACQUELIN	19
EGY	EGY2627	F	ALY NOURSIN	9
ENG	ENG297	F	Pomeroy Jasmine	28
ESP	ESP02988	F	ZUNIGA GARCIA INDIRA	15
FRA	FRA599	F	Avazeri Lea	12
FRA	FRA02778	F	YVON Sydney	14
FRA	FRA2566	F	ZAMETO HILLARY JENNIFER	22
GER	GER03113	F	KHAMIS REEM	1
IRI	IRI02709	F	GOLSHADNEZHAD ATOUSA	5
ITA	ITA03155	F	Graziosi Aurora	23
JPN	JPN02840	F	Shimada Sarara	4
KAZ	KAZ2198	F	KANAY ASSEL	3
KOS	KOS2051	F	ISTOGU ELMEDINA	30
LAT	LAT02561	F	GIRVICA BEATA	25
MAR	MAR2270	F	chajai fatima-zahra	7
MKD	MKD367	F	KOSTOVSKA VERONIKA	21
NED	NED02396	F	Kakiay Ashley	20
PER	PER129	F	Grande Alexandra	11
POL	POL06896	F	LEWANDOWSKA KATARZYNA	18
POR	POR2092	F	Almeida Baptista Renata	31
SUI	SUI2015	F	RADJENOVIC NINA	17
SWE	SWE201	F	NILSSON ANNA-JOHANNA	8
TUR	TUR794	F	GOZUTOK GULBAHAR	16
TUR	TUR2604	F	YENEN FATMA NAZ	6
UKR	UKR2280	F	SHOLOHOVA OLEKSANDRA	13

Female Kumite -61 Kg - Round Robin (each against each)

Karate1 Premier League - Paris 2025, Pierre de Coubertin Stadium, Avenue George Lafont 82, 75016 Paris, FRA

Tatami

Pool

1/8

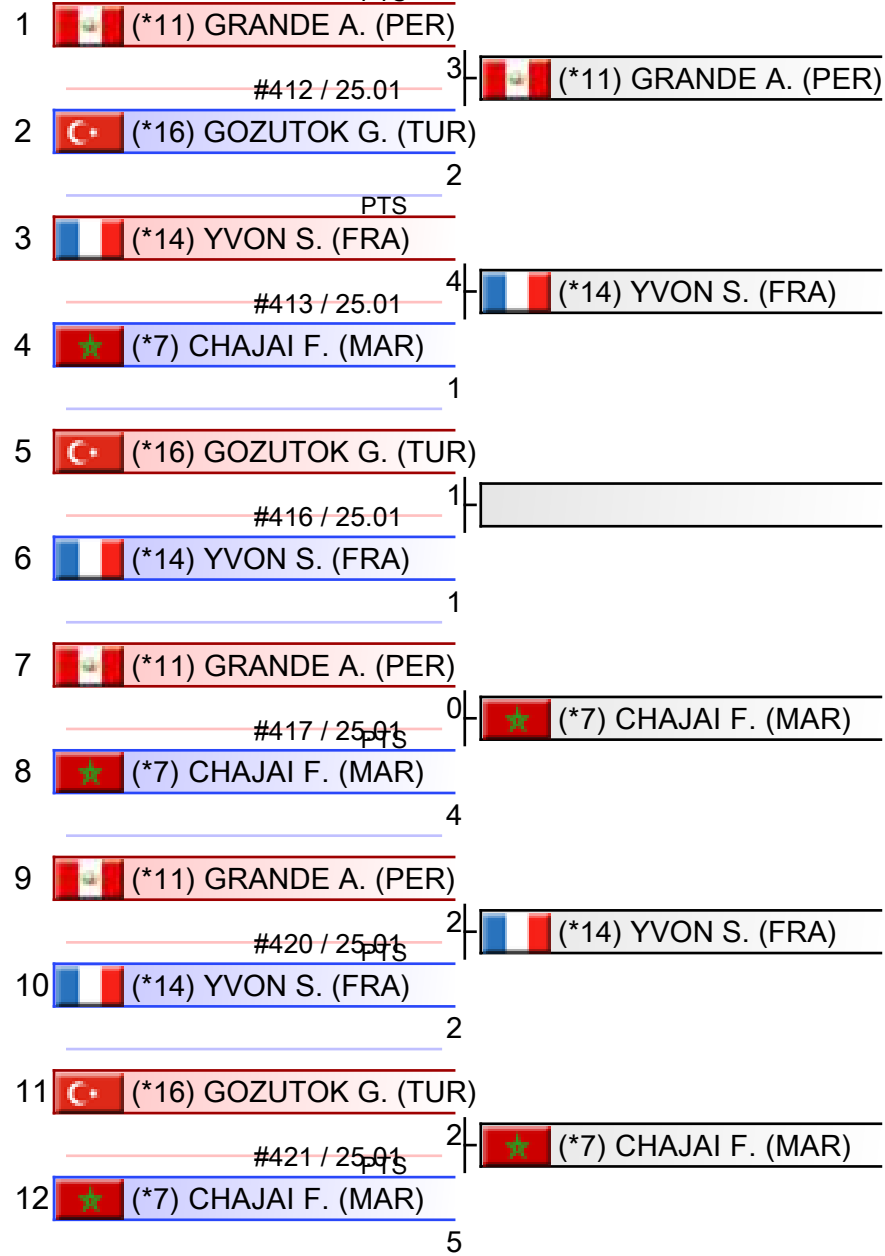

1. YVON SYDNEY (FRA)
2. CHAJAI FATIMA-ZAHRA (MAR)
3. GRANDE ALEXANDRA (PER)
4. GOZUTOK GULBAHAR (TUR)

1. SHIMADA SARARA (JPN)
2. KANAY ASSEL (KAZ)
3. GIRVICA BEATA (LAT)
3. YVON SYDNEY (FRA)
5. AVAZERI LEA (FRA)
5. KAKIAY ASHLEY (NED)
7. RADJENOVIC NINA (SUI)
7. NILSSON ANNA-JOHANNA (SWE)

*Seeded

Referees:			



1	(*29) HUAIQUIMAN B. (CHI)	#414 / 25.01	0	(*18) LEWANDOWSKA K. (POL)
2	(*18) LEWANDOWSKA K. (POL)		1	
3	(*5) GOLSHADNEZHAD A. (IRI)	#415 / 25.01	0	(*3) KANAY A. (KAZ)
4	(*3) KANAY A. (KAZ)		3	
5	(*18) LEWANDOWSKA K. (POL)	#418 / 25.01	1	(*5) GOLSHADNEZHAD A. (IRI)
6	(*5) GOLSHADNEZHAD A. (IRI)		2	
7	(*29) HUAIQUIMAN B. (CHI)	#419 / 25.01	0	(*3) KANAY A. (KAZ)
8	(*3) KANAY A. (KAZ)		2	
9	(*29) HUAIQUIMAN B. (CHI)	#422 / 25.01	0	
10	(*5) GOLSHADNEZHAD A. (IRI)		0	
11	(*18) LEWANDOWSKA K. (POL)	#423 / 25.01	0	(*3) KANAY A. (KAZ)
12	(*3) KANAY A. (KAZ)		6	

1. KANAY ASSEL (KAZ)
2. GOLSHADNEZHAD ATOUSA (IRI)
3. LEWANDOWSKA KATARZYNA (POL)
4. HUAIQUIMAN BARBARA (CHI)

1. SHIMADA SARARA (JPN)
2. KANAY ASSEL (KAZ)
3. GIRVICA BEATA (LAT)
3. YVON SYDNEY (FRA)
5. AVAZERI LEA (FRA)
5. KAKIAY ASHLEY (NED)
7. RADJENOVIC NINA (SUI)
7. NILSSON ANNA-JOHANNA (SWE)

*Seeded

Referees:			

Female Kumite -61 Kg - Round Robin (each against each)

Karate1 Premier League - Paris 2025, Pierre de Coubertin Stadium, Avenue George Lafont 82, 75016 Paris, FRA

Tatami

Pool
3/8



1	(*13) SHOLOHOVA O. (UKR)	6	(*13) SHOLOHOVA O. (UKR)
	#484 / 25.01		
2	(*17) RADJENOVIC N. (SUI)	4	
3	(*10) TOPALOVIC L. (AUT)	1	(*23) GRAZIOSI A. (ITA)
	#485 / 25.01		
4	(*23) GRAZIOSI A. (ITA)	7	
	PTS		
5	(*17) RADJENOVIC N. (SUI)	8	(*17) RADJENOVIC N. (SUI)
	#488 / 25.01		
6	(*10) TOPALOVIC L. (AUT)	5	
7	(*13) SHOLOHOVA O. (UKR)	2	(*23) GRAZIOSI A. (ITA)
	#489 / 25.01		
8	(*23) GRAZIOSI A. (ITA)	7	
9	(*13) SHOLOHOVA O. (UKR)	0	(*10) TOPALOVIC L. (AUT)
	#492 / 25.01		
10	(*10) TOPALOVIC L. (AUT)	8	
	HA		
11	(*17) RADJENOVIC N. (SUI)	6	(*17) RADJENOVIC N. (SUI)
	#493 / 25.01		
12	(*23) GRAZIOSI A. (ITA)	3	

1. RADJENOVIC NINA (SUI)
2. GRAZIOSI AURORA (ITA)
3. TOPALOVIC LEJLA (AUT)
4. SHOLOHOVA OLEKSANDRA (UKR)

1. SHIMADA SARARA (JPN)
2. KANAY ASSEL (KAZ)
3. GIRVICA BEATA (LAT)
3. YVON SYDNEY (FRA)
5. AVAZERI LEA (FRA)
5. KAKIAY ASHLEY (NED)
7. RADJENOVIC NINA (SUI)
7. NILSSON ANNA-JOHANNA (SWE)

*Seeded

Referees:			

Female Kumite -61 Kg - Round Robin (each against each)

Karate1 Premier League - Paris 2025, Pierre de Coubertin Stadium, Avenue George Lafont 82, 75016 Paris, FRA

Tatami

Pool
4/8



1	(*21) KOSTOVSKA V. (MKD)	#486 / 25.01	1
2	(*12) AVAZERI L. (FRA)	HA	1
3	(*24) SIPOVIC E. (BIH)	#487 / 25.01	4
4	(*2) AJARAY M. (BEL)		0
5	(*12) AVAZERI L. (FRA)	#490 / 25.01	
6	(*24) SIPOVIC E. (BIH)		
7	(*21) KOSTOVSKA V. (MKD)	#491 / 25.01	3
8	(*2) AJARAY M. (BEL)	PTS	6
9	(*21) KOSTOVSKA V. (MKD)	#494 / 25.01	
10	(*24) SIPOVIC E. (BIH)		
11	(*12) AVAZERI L. (FRA)	PTS	1
12	(*2) AJARAY M. (BEL)	#495 / 25.01	1

1. AVAZERI LEA (FRA)
2. AJARAY MARYAM (BEL)
3. KOSTOVSKA VERONIKA (MKD)
4. SIPOVIC EMINA (BIH)

1. SHIMADA SARARA (JPN)
2. KANAY ASSEL (KAZ)
3. GIRVICA BEATA (LAT)
3. YVON SYDNEY (FRA)
5. AVAZERI LEA (FRA)
5. KAKIAY ASHLEY (NED)
7. RADJENOVIC NINA (SUI)
7. NILSSON ANNA-JOHANNA (SWE)

*Seeded

Referees:			

Female Kumite -61 Kg - Round Robin (each against each)

Karate1 Premier League - Paris 2025, Pierre de Coubertin Stadium, Avenue George Lafont 82, 75016 Paris, FRA

Tatami

Pool
5/8



1	(*25) GIRVICA B. (LAT)	#553 / 25.01	8	(*25) GIRVICA B. (LAT)
2	(*22) ZAMETO H. (FRA)	PTS	0	
3	(*26) RODRIGUES B. (BRA)	#554 / 25.01	8	(*26) RODRIGUES B. (BRA)
4	(*28) POMEROY J. (ENG)	PTS	1	
5	(*22) ZAMETO H. (FRA)	#557 / 25.01	1	(*26) RODRIGUES B. (BRA)
6	(*26) RODRIGUES B. (BRA)	PTS	3	
7	(*25) GIRVICA B. (LAT)	#558 / 25.01	2	(*25) GIRVICA B. (LAT)
8	(*28) POMEROY J. (ENG)	HA	0	
9	(*25) GIRVICA B. (LAT)	#561 / 25.01	3	(*25) GIRVICA B. (LAT)
10	(*26) RODRIGUES B. (BRA)	PTS	4	
11	(*22) ZAMETO H. (FRA)	#562 / 25.01	9	(*22) ZAMETO H. (FRA)
12	(*28) POMEROY J. (ENG)	PTS	2	

1. GIRVICA BEATA (LAT)
2. RODRIGUES BARBARA (BRA)
3. ZAMETO HILLARY JENNIFER (FRA)
4. POMEROY JASMINE (ENG)

1. SHIMADA SARARA (JPN)
2. KANAY ASSEL (KAZ)
3. GIRVICA BEATA (LAT)
3. YVON SYDNEY (FRA)
5. AVAZERI LEA (FRA)
5. KAKIAY ASHLEY (NED)
7. RADJENOVIC NINA (SUI)
7. NILSSON ANNA-JOHANNA (SWE)

*Seeded

Referees:			

Female Kumite -61 Kg - Round Robin (each against each)

Karate1 Premier League - Paris 2025, Pierre de Coubertin Stadium, Avenue George Lafont 82, 75016 Paris, FRA

Tatami

Pool
6/8



1	(*27) CACKO M. (CRO)	#555 / 25-015	0	(*19) FACTOS J. (ECU)
2	(*19) FACTOS J. (ECU)		3	
3	(*6) YENEN F. (TUR)	#556 / 25-015	0	(*4) SHIMADA S. (JPN)
4	(*4) SHIMADA S. (JPN)		6	
5	(*19) FACTOS J. (ECU)	#559 / 25-015	0	(*6) YENEN F. (TUR)
6	(*6) YENEN F. (TUR)		4	
7	(*27) CACKO M. (CRO)	#560 / 25-015	0	(*4) SHIMADA S. (JPN)
8	(*4) SHIMADA S. (JPN)		1	
9	(*27) CACKO M. (CRO)	#563 / 25-015	1	(*6) YENEN F. (TUR)
10	(*6) YENEN F. (TUR)		4	
11	(*19) FACTOS J. (ECU)	#564 / 25-015	1	(*4) SHIMADA S. (JPN)
12	(*4) SHIMADA S. (JPN)		3	

1. SHIMADA SARARA (JPN)
2. YENEN FATMA NAZ (TUR)
3. FACTOS JACQUELIN (ECU)
4. CACKO MIA (CRO)

1. SHIMADA SARARA (JPN)
2. KANAY ASSEL (KAZ)
3. GIRVICA BEATA (LAT)
3. YVON SYDNEY (FRA)
5. AVAZERI LEA (FRA)
5. KAKIAY ASHLEY (NED)
7. RADJENOVIC NINA (SUI)
7. NILSSON ANNA-JOHANNA (SWE)

*Seeded

Referees:			

Female Kumite -61 Kg - Round Robin (each against each)

Karate1 Premier League - Paris 2025, Pierre de Coubertin Stadium, Avenue George Lafont 82, 75016 Paris, FRA

Tatami

Pool
7/8



1. KAKIAY ASHLEY (NED)
2. ISTOGU ELMEDINA (KOS)
3. ALMEIDA BAPTISTA RENATA (POR)
4. ALY NOURSIN (EGY)

1. SHIMADA SARARA (JPN)
2. KANAY ASSEL (KAZ)
3. GIRVICA BEATA (LAT)
3. YVON SYDNEY (FRA)
5. AVAZERI LEA (FRA)
5. KAKIAY ASHLEY (NED)
7. RADJENOVIC NINA (SUI)
7. NILSSON ANNA-JOHANNA (SWE)

*Seeded

Referees:			

Female Kumite -61 Kg - Round Robin (each against each)

Karate1 Premier League - Paris 2025, Pierre de Coubertin Stadium, Avenue George Lafont 82, 75016 Paris, FRA

Tatami

Pool
8/8

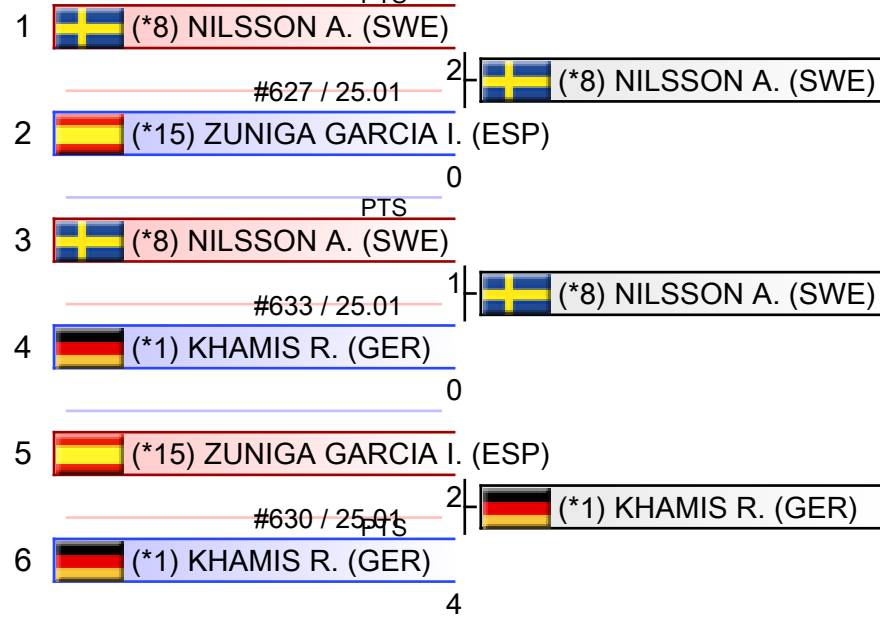

1. NILSSON ANNA-JOHANNA (SWE)
2. KHAMIS REEM (GER)
3. ZUNIGA GARCIA INDIRA (ESP)

1. SHIMADA SARARA (JPN)
2. KANAY ASSEL (KAZ)
3. GIRVICA BEATA (LAT)
3. YVON SYDNEY (FRA)
5. AVAZERI LEA (FRA)
5. KAKIAY ASHLEY (NED)
7. RADJENOVIC NINA (SUI)
7. NILSSON ANNA-JOHANNA (SWE)

*Seeded

Referees:			

Pool winner-Female Kumite -61 Kg

Karate1 Premier League - Paris 2025, Pierre de Coubertin Stadium, Avenue George Lafont 82, 75016 Paris, FRA

Tatami

Pool
1/1

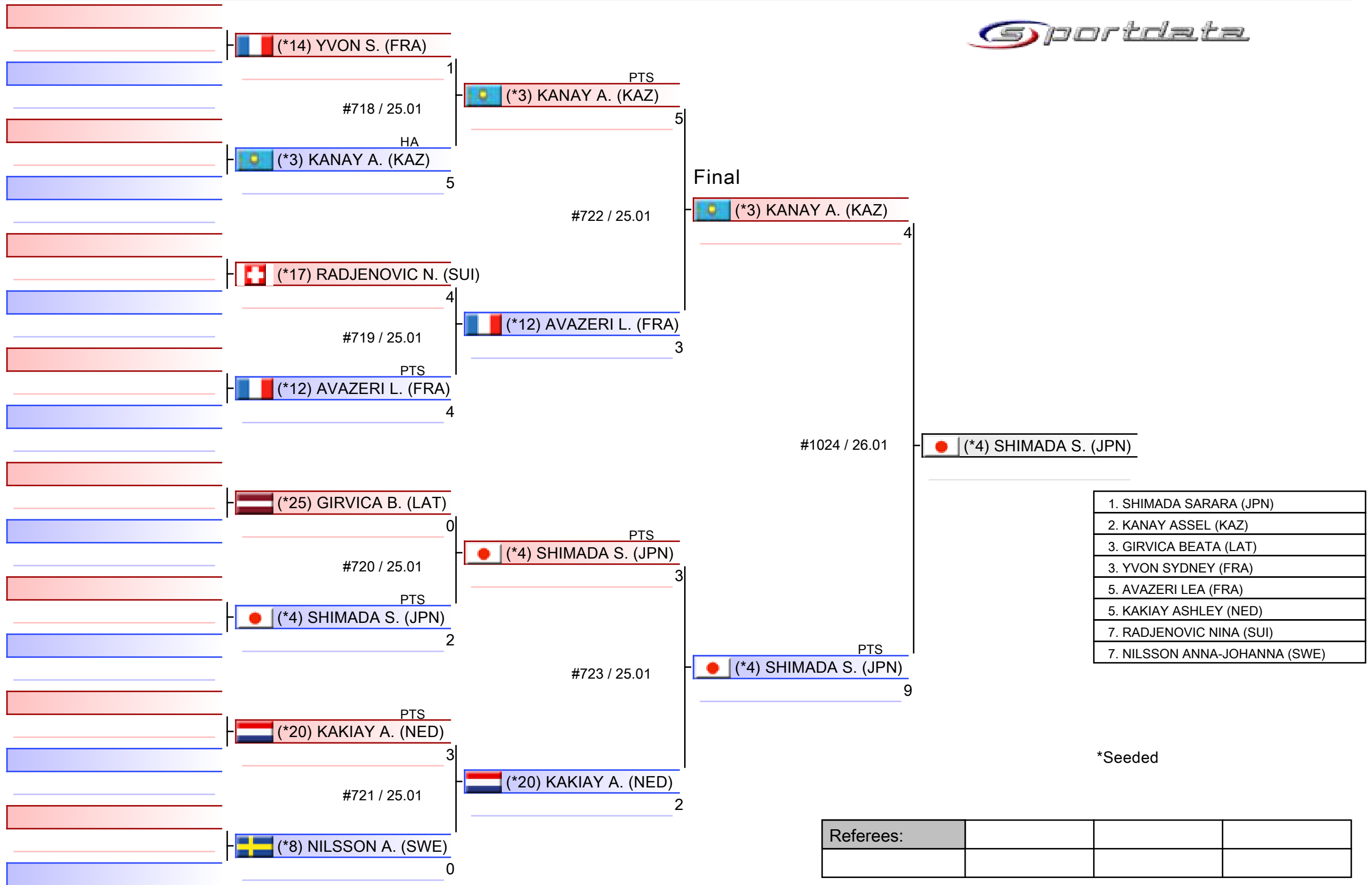

Female Kumite -61 Kg

Karate1 Premier League - Paris 2025

Tatami

Pool
1,2,3,4,5,6,7,8

(c)sportdata GmbH & Co KG 2000-2025 (2025-01-27 23:36) v 10.2.0 build 1 (2025-01-18 23:49 CET) License: SDIL 2025 (expire 2025-12-31)

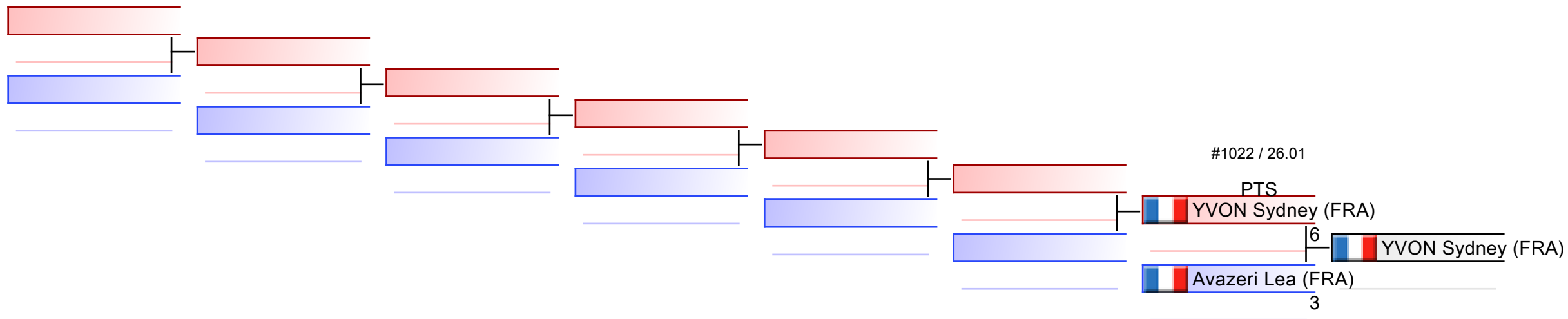

REPECHAGE: (1,2,3,4,5,6,7,8)

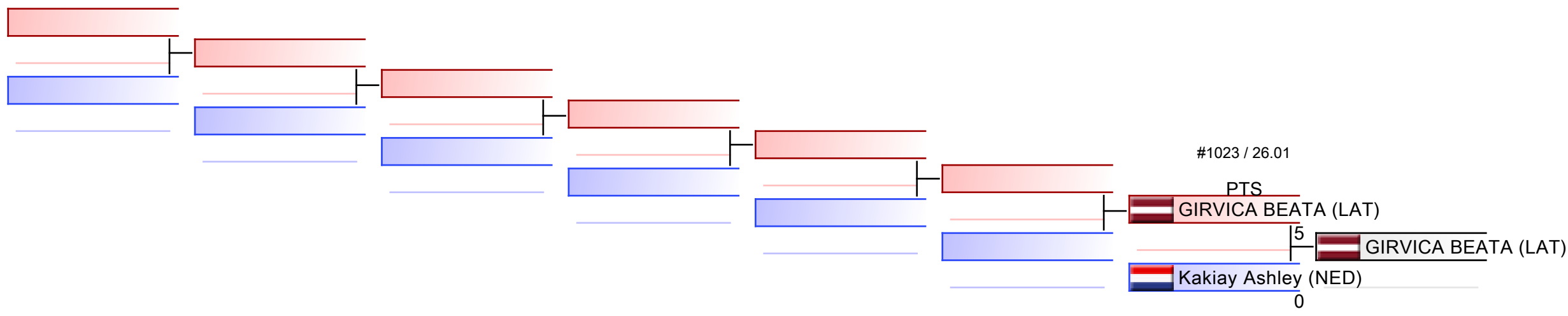

Referees:							
-----------	--	--	--	--	--	--	--

FEMALE KUMITE -68 KG



Karate1 Premier League - Paris 2025

ENTRIES BY WEIGHT CATEGORY



Female Kumite -68 Kg

As of 27 JAN 2025

Country Code	ID	Gender	Name	Seeding
ARM	ARM2003	F	MAKYAN ANITA	28
AUT	AUT2231	F	VUKOVIC MARINA	29
CHI	CHI03118	F	VELOZO ANASTASIIA	20
CRO	CRO2104	F	BECIROVIC SADEA	27
CRO	CRO2250	F	VUKOJA LEA	15
EGY	EGY2220	F	ABDELAZIZ FERYAL	24
EGY	EGY2194	F	HENDY HADIR	18
ENG	ENG2163	F	Salisbury Lauren	30
ESP	ESP2359	F	NIETO MEJIAS MARIA ISABEL	5
FRA	FRA357	F	AGIER ALIZEE	3
FRA	FRA02723	F	SOMBE Thalya	4
GER	GER2080	F	SCHROETER MADELEINE	19
GRE	GRE2036	F	PEPPA KONSTANTINA-EVANGELIA	22
HKG	HKG2148	F	WONG CHEUK LEE	13
INA	INA66e2ee6e40fe9	F	ZEFANYA CEYCO GEORGIA	8
IRI	IRI2132	F	HEYDARIOZOMCHELOE MOBINA	11
ITA	ITA2385	F	Bodei Pamela	14
ITA	ITA04269	F	DESIDERIO ANNA PIA	17
ITA	ITA377	F	SEMERARO Silvia	7
JPN	JPN03040	F	KAMA TSUBASA	2
JPN	SD79143	F	Nagai Kanna	26
KAZ	KAZ02650	F	SAGYNBEK LAURA	23
MAR	MAR2238	F	BROUK NISRINE	31
POL	POL3057	F	GREJNER WIKTORIA	21
PUR	PUR2007	F	FONSECA ROMERO JANESSA MICHELLE	6
SUI	SUI202	F	QUIRICI ELENA	1
TUN	TUN02803	F	ETTALEB MERIAME	25
TUN	TUN02793	F	EZZAR WISSAL	12
TUR	TUR2420	F	AKSOY SUDENUR	9
TUR	TUR786	F	ELTEMUR EDA	16
UKR	UKR2373	F	SIELIEMIENIEVA ELINA	10

Female Kumite -68 Kg - Round Robin (each against each)

Karate1 Premier League - Paris 2025, Pierre de Coubertin Stadium, Avenue George Lafont 82, 75016 Paris, FRA

Tatami

Pool
1/8



1	(*23) SAGYNBEK L. (KAZ)	#436 / 25.01	1	(*23) SAGYNBEK L. (KAZ)
2	(*21) GREJNER W. (POL)		0	
3	(*7) SEMERARO S. (ITA)	#437 / 25.01	0	
4	(*16) ELTEMUR E. (TUR)		0	
5	(*21) GREJNER W. (POL)	#440 / 25.01	0	(*7) SEMERARO S. (ITA)
6	(*7) SEMERARO S. (ITA)		1	
7	(*23) SAGYNBEK L. (KAZ)	#441 / 25.01	1	(*16) ELTEMUR E. (TUR)
8	(*16) ELTEMUR E. (TUR)		6	
9	(*23) SAGYNBEK L. (KAZ)	#444 / 25.01	0	(*7) SEMERARO S. (ITA)
10	(*7) SEMERARO S. (ITA)		0	
11	(*21) GREJNER W. (POL)	#445 / 25.01	0	(*16) ELTEMUR E. (TUR)
12	(*16) ELTEMUR E. (TUR)		6	

1. ELTEMUR EDA (TUR)
2. SEMERARO SILVIA (ITA)
3. SAGYNBEK LAURA (KAZ)
4. GREJNER WIKTORIA (POL)

1. SOMBE THALYA (FRA)
2. KAMA TSUBASA (JPN)
3. QUIRICI ELENA (SUI)
3. ELTEMUR EDA (TUR)
5. NIETO MEJIAS MARIA ISABEL (ESP)
5. FONSECA ROMERO JANESEA MICHELLE (PUR)
7. HENDY HADIR (EGY)
7. BECIROVIC SADEA (CRO)

*Seeded

Referees:			

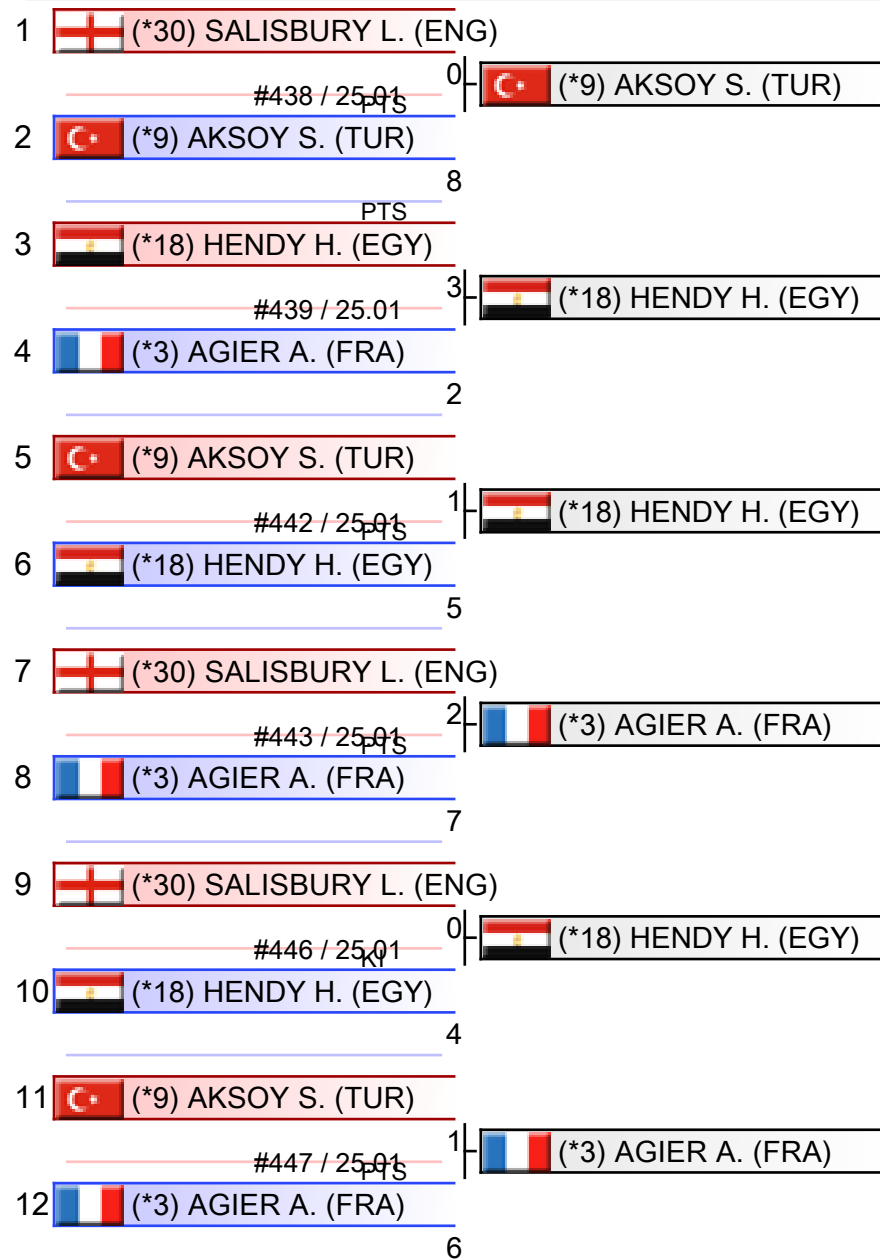

1. HENDY HADIR (EGY)
2. AGIER ALIZEE (FRA)
3. AKSOY SUDENUR (TUR)
4. SALISBURY LAUREN (ENG)

1. SOMBE THALYA (FRA)
2. KAMA TSUBASA (JPN)
3. QUIRICI ELENA (SUI)
3. ELTEMUR EDA (TUR)
5. NIETO MEJIAS MARIA ISABEL (ESP)
5. FONSECA ROMERO JANESEA MICHELLE (PUR)
7. HENDY HADIR (EGY)
7. BECIROVIC SADEA (CRO)

*Seeded

Referees:			

Female Kumite -68 Kg - Round Robin (each against each)

Karate1 Premier League - Paris 2025, Pierre de Coubertin Stadium, Avenue George Lafont 82, 75016 Paris, FRA

Tatami

Pool
3/8



1	(*22) PEPPA K. (GRE)	3	(*8) ZEFANYA C. (INA)
	#508 / 25.01		
2	(*8) ZEFANYA C. (INA)	6	
	PTS		
3	(*5) NIETO MEJIAS M. (ESP)	6	(*5) NIETO MEJIAS M. (ESP)
	#509 / 25.01		
4	(*28) MAKYAN A. (ARM)	6	
5	(*8) ZEFANYA C. (INA)	7	(*5) NIETO MEJIAS M. (ESP)
	#512 / 25.01		
6	(*5) NIETO MEJIAS M. (ESP)	10	
7	(*22) PEPPA K. (GRE)	6	(*28) MAKYAN A. (ARM)
	#513 / 25.01		
8	(*28) MAKYAN A. (ARM)	6	
9	(*22) PEPPA K. (GRE)	1	(*5) NIETO MEJIAS M. (ESP)
	#516 / 25.01		
10	(*5) NIETO MEJIAS M. (ESP)	4	
	PTS		
11	(*8) ZEFANYA C. (INA)	6	(*8) ZEFANYA C. (INA)
	#517 / 25.01		
12	(*28) MAKYAN A. (ARM)	1	

1. NIETO MEJIAS MARIA ISABEL (ESP)
2. ZEFANYA CEYCO GEORGIA (INA)
3. MAKYAN ANITA (ARM)
4. PEPPA KONSTANTINA-EVANGELIA (GRE)

1. SOMBE THALYA (FRA)
2. KAMA TSUBASA (JPN)
3. QUIRICI ELENA (SUI)
3. ELTEMUR EDA (TUR)
5. NIETO MEJIAS MARIA ISABEL (ESP)
5. FONSECA ROMERO JANESSA MICHELLE (PUR)
7. HENDY HADIR (EGY)
7. BECIROVIC SADEA (CRO)

*Seeded

Referees:			

Female Kumite -68 Kg - Round Robin (each against each)

Karate1 Premier League - Paris 2025, Pierre de Coubertin Stadium, Avenue George Lafont 82, 75016 Paris, FRA

Tatami

Pool
4/8



1	(*20) VELOZO A. (CHI)	2	(*17) DESIDERIO A. (ITA)
	#510 / 25.01		
2	(*17) DESIDERIO A. (ITA)	3	
3	(*12) EZZAR W. (TUN)	3	(*2) KAMA T. (JPN)
	#511 / 25.01		
4	(*2) KAMA T. (JPN)	5	
	PTS		
5	(*17) DESIDERIO A. (ITA)	1	(*17) DESIDERIO A. (ITA)
	#514 / 25.01		
6	(*12) EZZAR W. (TUN)	1	
	PTS		
7	(*20) VELOZO A. (CHI)	1	(*2) KAMA T. (JPN)
	#515 / 25.01		
8	(*2) KAMA T. (JPN)	6	
	PTS		
9	(*20) VELOZO A. (CHI)	10	(*20) VELOZO A. (CHI)
	#518 / 25.01		
10	(*12) EZZAR W. (TUN)	2	
	PTS		
11	(*17) DESIDERIO A. (ITA)	3	(*2) KAMA T. (JPN)
	#519 / 25.01		
12	(*2) KAMA T. (JPN)	5	

1. KAMA TSUBASA (JPN)
2. DESIDERIO ANNA PIA (ITA)
3. VELOZO ANASTASIIA (CHI)
4. EZZAR WISSAL (TUN)

1. SOMBE THALYA (FRA)
2. KAMA TSUBASA (JPN)
3. QUIRICI ELENA (SUI)
3. ELTEMUR EDA (TUR)
5. NIETO MEJIAS MARIA ISABEL (ESP)
5. FONSECA ROMERO JANESSA MICHELLE (PUR)
7. HENDY HADIR (EGY)
7. BECIROVIC SADEA (CRO)

*Seeded

Referees:			

Female Kumite -68 Kg - Round Robin (each against each)

Karate1 Premier League - Paris 2025, Pierre de Coubertin Stadium, Avenue George Lafont 82, 75016 Paris, FRA

Tatami

Pool
5/8



1	(*11) HEYDARIOZOMCHELOE M. (IRI)	9	(*11) HEYDARIOZOMCHELOE M. (IRI)
	#577 / 25.01		
2	(*29) VUKOVIC M. (AUT)	1	
3	(*6) FONSECA ROMERO J. (PUR)	3	
	#578 / 25.01		
4	(*24) ABDELAZIZ F. (EGY)	3	
5	(*29) VUKOVIC M. (AUT)	2	(*6) FONSECA ROMERO J. (PUR)
	#581 / 25.01		
6	(*6) FONSECA ROMERO J. (PUR)	7	
	PTS		
7	(*11) HEYDARIOZOMCHELOE M. (IRI)	3	(*11) HEYDARIOZOMCHELOE M. (IRI)
	#582 / 25.01		
8	(*24) ABDELAZIZ F. (EGY)	1	
9	(*11) HEYDARIOZOMCHELOE M. (IRI)	0	(*6) FONSECA ROMERO J. (PUR)
	#585 / 25.01		
10	(*6) FONSECA ROMERO J. (PUR)	4	
11	(*29) VUKOVIC M. (AUT)	0	(*24) ABDELAZIZ F. (EGY)
	#586 / 25.01		
12	(*24) ABDELAZIZ F. (EGY)	2	

1. FONSECA ROMERO JANESEA MICHELLE (PUR)
2. HEYDARIOZOMCHELOE MOBINA (IRI)
3. ABDELAZIZ FERYAL (EGY)
4. VUKOVIC MARINA (AUT)

1. SOMBE THALYA (FRA)
2. KAMA TSUBASA (JPN)
3. QUIRICI ELENA (SUI)
3. ELTEMUR EDA (TUR)
5. NIETO MEJIAS MARIA ISABEL (ESP)
5. FONSECA ROMERO JANESEA MICHELLE (PUR)
7. HENDY HADIR (EGY)
7. BECIROVIC SADEA (CRO)

*Seeded

Referees:			

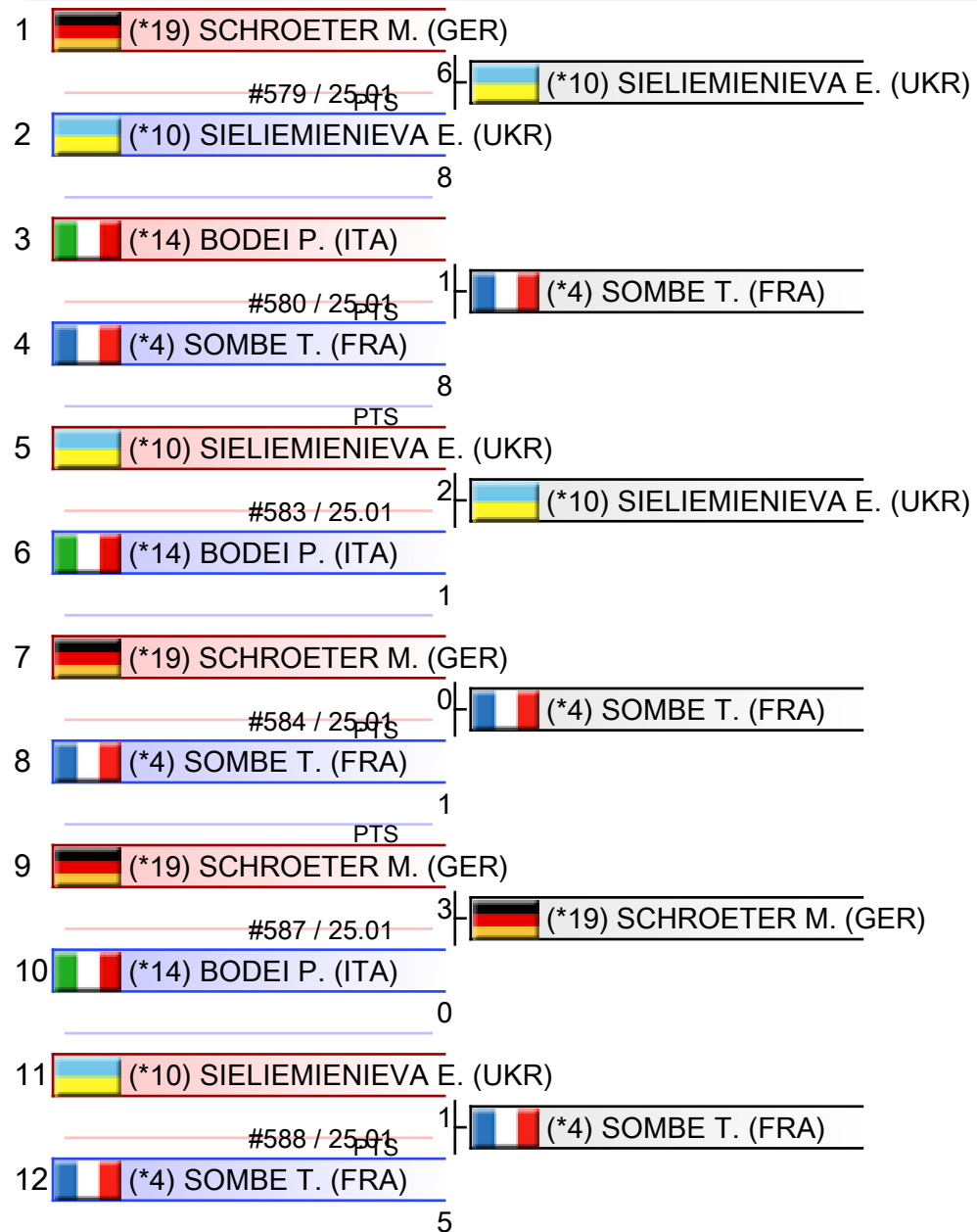

1. SOMBE THALYA (FRA)
2. SIELIEMIENIEVA ELINA (UKR)
3. SCHROETER MADELEINE (GER)
4. BODEI PAMELA (ITA)

1. SOMBE THALYA (FRA)
2. KAMA TSUBASA (JPN)
3. QUIRICI ELENA (SUI)
3. ELTEMUR EDA (TUR)
5. NIETO MEJIAS MARIA ISABEL (ESP)
5. FONSECA ROMERO JANESSA MICHELLE (PUR)
7. HENDY HADIR (EGY)
7. BECIROVIC SADEA (CRO)

*Seeded

Referees:			

Female Kumite -68 Kg - Round Robin (each against each)

Karate1 Premier League - Paris 2025, Pierre de Coubertin Stadium, Avenue George Lafont 82, 75016 Paris, FRA

Tatami

Pool
7/8



1	(*27) BECIROVIC S. (CRO)	#646 / 25.01	4	(*27) BECIROVIC S. (CRO)
2	(*25) ETTALEB M. (TUN)		1	
3	(*26) NAGAI K. (JPN)	#647 / 25.01	5	(*26) NAGAI K. (JPN)
4	(*31) BROUK N. (MAR)		4	
5	(*25) ETTALEB M. (TUN)	#649 / 25.01	0	(*26) NAGAI K. (JPN)
6	(*26) NAGAI K. (JPN)		5	
7	(*27) BECIROVIC S. (CRO)	#650 / 25.01	4	(*27) BECIROVIC S. (CRO)
8	(*31) BROUK N. (MAR)		2	
9	(*27) BECIROVIC S. (CRO)	#652 / 25.01	4	(*27) BECIROVIC S. (CRO)
10	(*26) NAGAI K. (JPN)		0	
11	(*25) ETTALEB M. (TUN)	#653 / 25.01	5	(*31) BROUK N. (MAR)
12	(*31) BROUK N. (MAR)		14	

1. BECIROVIC SADEA (CRO)
2. NAGAI KANNA (JPN)
3. BROUK NISRINE (MAR)
4. ETTALEB MERIAME (TUN)

1. SOMBE THALYA (FRA)
2. KAMA TSUBASA (JPN)
3. QUIRICI ELENA (SUI)
3. ELTEMUR EDA (TUR)
5. NIETO MEJIAS MARIA ISABEL (ESP)
5. FONSECA ROMERO JANESEA MICHELLE (PUR)
7. HENDY HADIR (EGY)
7. BECIROVIC SADEA (CRO)

*Seeded

Referees:			

Female Kumite -68 Kg - Round Robin (each against each)

Karate1 Premier League - Paris 2025, Pierre de Coubertin Stadium, Avenue George Lafont 82, 75016 Paris, FRA

Tatami

Pool
8/8



1	(*13) WONG C. (HKG)	
	#648 / 25-015	1 (*15) VUKOJA L. (CRO)
2	(*15) VUKOJA L. (CRO)	2
3	(*13) WONG C. (HKG)	
	#654 / 25-015	1 (*1) QUIRICI E. (SUI)
4	(*1) QUIRICI E. (SUI)	5
5	(*15) VUKOJA L. (CRO)	
	#651 / 25-015	0 (*1) QUIRICI E. (SUI)
6	(*1) QUIRICI E. (SUI)	3

1. QUIRICI ELENA (SUI)
2. VUKOJA LEA (CRO)
3. WONG CHEUK LEE (HKG)

1. SOMBE THALYA (FRA)
2. KAMA TSUBASA (JPN)
3. QUIRICI ELENA (SUI)
3. ELTEMUR EDA (TUR)
5. NIETO MEJIAS MARIA ISABEL (ESP)
5. FONSECA ROMERO JANESEA MICHELLE (PUR)
7. HENDY HADIR (EGY)
7. BECIROVIC SADEA (CRO)

*Seeded

Referees:			

Pool winner-Female Kumite -68 Kg

Karate1 Premier League - Paris 2025, Pierre de Coubertin Stadium, Avenue George Lafont 82, 75016 Paris, FRA

Tatami

Pool
1/1

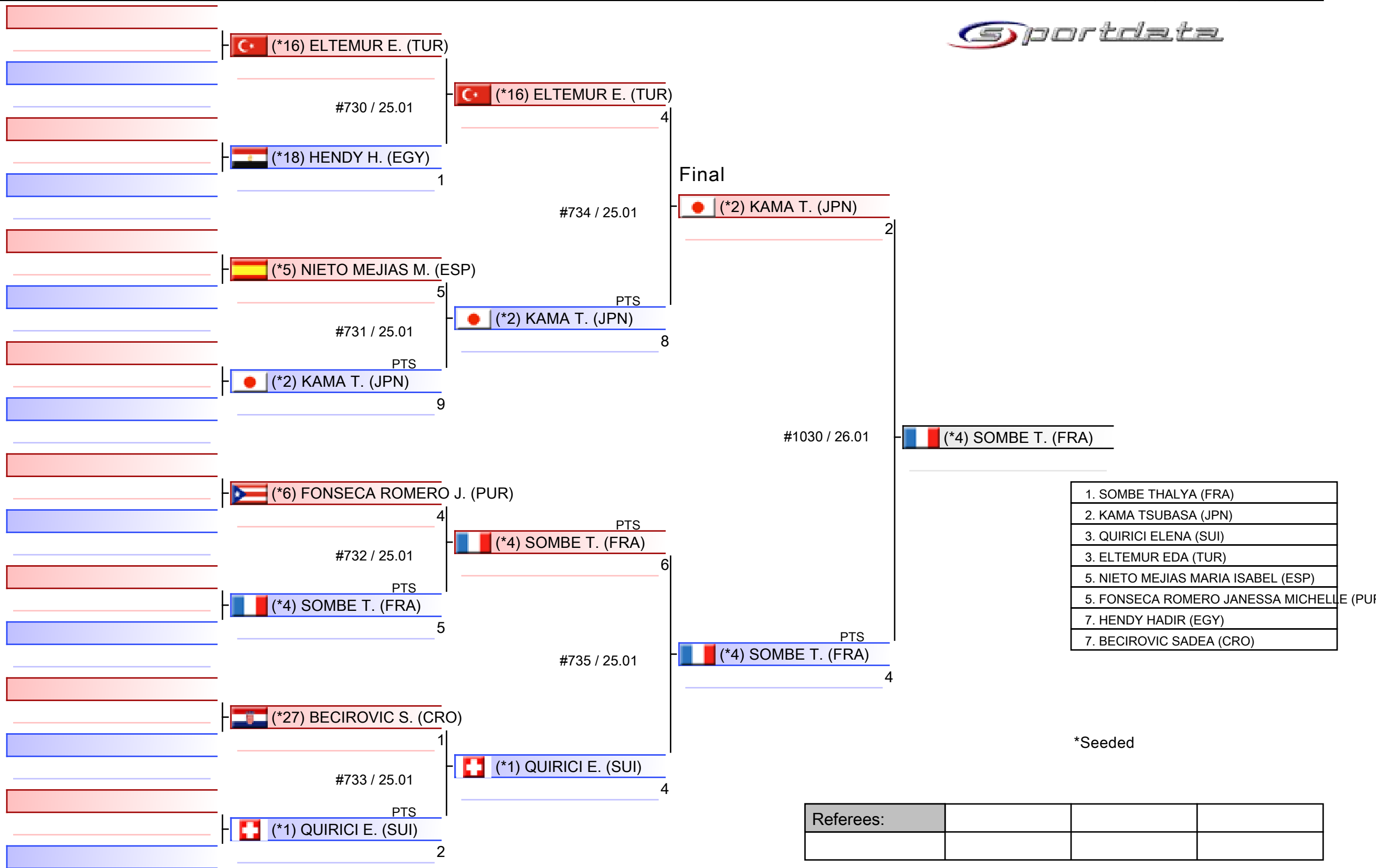

Female Kumite -68 Kg

Karate1 Premier League - Paris 2025

Tatami

Pool

1,2,3,4,5,6,7,8

(c)sportdata GmbH & Co KG 2000-2025 (2025-01-27 23:36) v 10.2.0 build 1 (2025-01-18 23:49 CET) License: SDIL 2025 (expire 2025-12-31)

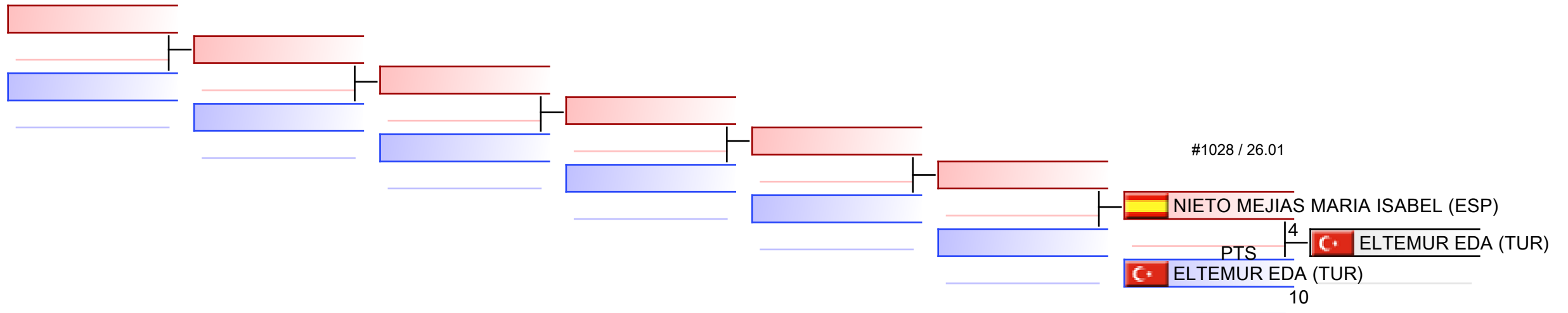

REPECHAGE: (1,2,3,4,5,6,7,8)

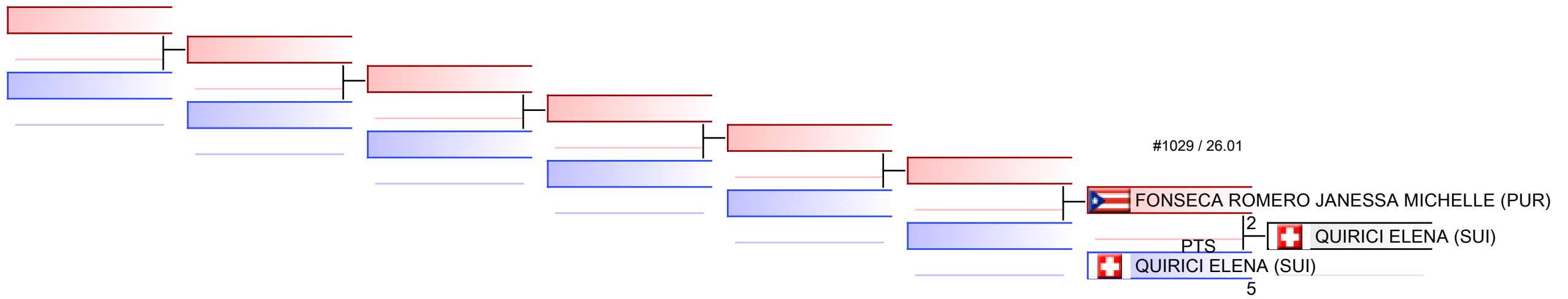

Referees:							
-----------	--	--	--	--	--	--	--

FEMALE KUMITE 68+ KG



Karate1 Premier League - Paris 2025

ENTRIES BY WEIGHT CATEGORY



Female Kumite 68+ Kg

As of 27 JAN 2025

Country Code	ID	Gender	Name	Seeding
ALG	ALG2482	F	OUDIRA CHAIMA	23
AUS	AUS2194	F	SULLIVAN HANNAH	24
BIH	BIH2269	F	KRESIC STEFANI	13
CAN	CAN2308	F	NOLET LILY-ROSE	20
CHI	CHI129	F	GONZALEZ LAVIN JAVIERA	18
CRO	CRO2077	F	LESJAK LUCIJA	10
CYP	CYP02713	F	GIAMOUKI THEODOSIA	22
EGY	EGY2732	F	HELMY HABIBA	30
ENG	ENG2406	F	WALTERS ROCHELLE	5
ESP	ESP2007	F	TORRES GARCIA MARIA	2
FRA	FRA372	F	GARCIA NANCY	6
GER	GER2090	F	KNEER JOHANNA	3
GER	GER2565	F	LUECKE AMELIE	11
GER	GER411	F	Yildirim Meryem	32
ITA	ITA570	F	Ferracuti Clio	4
KAZ	KAZ2140	F	BERULTSEVA SOFYA	1
KOS	KOS2014	F	ORANA FORTESA	27
MAR	MAR02618	F	EDDARHRI Maroua	12
NED	NED221	F	Creemers Ingrid	21
NED	NED2346	F	van Wezel Robin	31
POL	POL4033	F	DANISZEWSKA JULIA	14
POR	POR251	F	OLIVEIRA ANA RITA	17
SCO	SCO2098	F	JUNNER NIAMH	9
SLO	SLO2448	F	ZIBRET ZALA MARIA	26
SUI	SUI2030	F	BONJOUR PAULINE	19
SUI	SUI2005	F	KAUFMANN FABIENNE	7
SWE	SWE02480	F	BAO BEDNARSKI SOPHIE	28
TUN	TUN203	F	JEMI CHEHINEZ	8
TUR	TUR04113	F	gaballa zeyna	29
TUR	TUR308	F	HOCAOGLU AKYOL MELTEM	15
TUR	TUR2415	F	UYGUR FATMA	25
UKR	UKR02524	F	RUSU YULIA	16

Female Kumite 68+ Kg - Round Robin (each against each)

Karate1 Premier League - Paris 2025, Pierre de Coubertin Stadium, Avenue George Lafont 82, 75016 Paris, FRA

Tatami

Pool

1/8



1	(*30) HELMY H. (EGY)	
	#460 / 25.01	3
2	(*9) JUNNER N. (SCO)	
		3
3	(*10) LESJAK L. (CRO)	
	#461 / 25.01	1
4	(*14) DANISZEWSKA J. (POL)	
		4
	PTS	
5	(*9) JUNNER N. (SCO)	
	#464 / 25.01	2
6	(*10) LESJAK L. (CRO)	
		1
	PTS	
7	(*30) HELMY H. (EGY)	
	#465 / 25.01	2
8	(*14) DANISZEWSKA J. (POL)	
		0
9	(*30) HELMY H. (EGY)	
	#468 / 25.01	1
10	(*10) LESJAK L. (CRO)	
		5
11	(*9) JUNNER N. (SCO)	
	#469 / 25.01	5
12	(*14) DANISZEWSKA J. (POL)	
		7

1. DANISZEWSKA JULIA (POL)
2. JUNNER NIAMH (SCO)
3. HELMY HABIBA (EGY)
4. LESJAK LUCIJA (CRO)

1. TORRES GARCIA MARIA (ESP)
2. BERULTSEVA SOFYA (KAZ)
3. WALTERS ROCHELLE (ENG)
3. EDDARHRI MAROUA (MAR)
5. KNEER JOHANNA (GER)
5. CREEMERS INGRID (NED)
7. DANISZEWSKA JULIA (POL)
7. FERRACUTI CLIO (ITA)

*Seeded

Referees:			

Female Kumite 68+ Kg - Round Robin (each against each)

Karate1 Premier League - Paris 2025, Pierre de Coubertin Stadium, Avenue George Lafont 82, 75016 Paris, FRA

Tatami

Pool
2/8

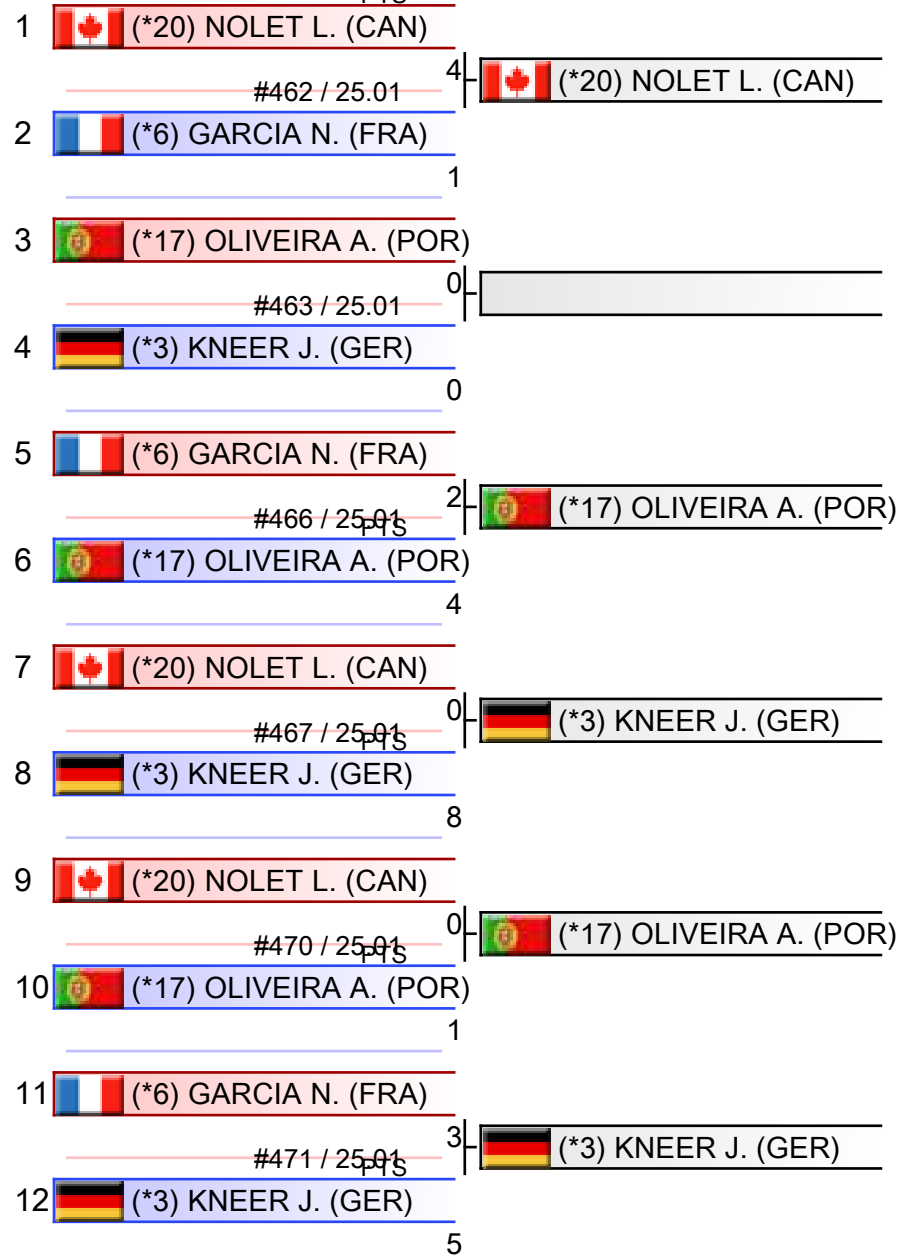

1. KNEER JOHANNA (GER)
2. OLIVEIRA ANA RITA (POR)
3. NOLET LILY-ROSE (CAN)
4. GARCIA NANCY (FRA)

1. TORRES GARCIA MARIA (ESP)
2. BERULTSEVA SOFYA (KAZ)
3. WALTERS ROCHELLE (ENG)
3. EDDARHRI MAROUA (MAR)
5. KNEER JOHANNA (GER)
5. CREEMERS INGRID (NED)
7. DANISZEWSKA JULIA (POL)
7. FERRACUTI CLIO (ITA)

*Seeded

Referees:			

Female Kumite 68+ Kg - Round Robin (each against each)

Karate1 Premier League - Paris 2025, Pierre de Coubertin Stadium, Avenue George Lafont 82, 75016 Paris, FRA

Tatami

Pool
3/8



1	(*8) JEMI C. (TUN)	2	(*8) JEMI C. (TUN)
	#529 / 25.01		
2	(*29) GABALLA Z. (TUR)	1	
3	(*26) ZIBRET Z. (SLO)	5	(*5) WALTERS R. (ENG)
	#530 / 25.01		
4	(*5) WALTERS R. (ENG)	6	
5	(*29) GABALLA Z. (TUR)	5	(*26) ZIBRET Z. (SLO)
	#533 / 25.01		
6	(*26) ZIBRET Z. (SLO)	9	
7	(*8) JEMI C. (TUN)	3	(*5) WALTERS R. (ENG)
	#534 / 25.01		
8	(*5) WALTERS R. (ENG)	8	
9	(*8) JEMI C. (TUN)	0	
	#537 / 25.01		
10	(*26) ZIBRET Z. (SLO)	0	
11	(*29) GABALLA Z. (TUR)	4	(*5) WALTERS R. (ENG)
	#538 / 25.01		
12	(*5) WALTERS R. (ENG)	5	

1. WALTERS ROCHELLE (ENG)
2. ZIBRET ZALA MARIA (SLO)
3. JEMI CHEHINEZ (TUN)
4. GABALLA ZEYNA (TUR)

1. TORRES GARCIA MARIA (ESP)
2. BERULTSEVA SOFYA (KAZ)
3. WALTERS ROCHELLE (ENG)
3. EDDARHRI MAROUA (MAR)
5. KNEER JOHANNA (GER)
5. CREEMERS INGRID (NED)
7. DANISZEWSKA JULIA (POL)
7. FERRACUTI CLIO (ITA)

*Seeded

Referees:			



1	(*16) RUSU Y. (UKR)	0	(*25) UYGUR F. (TUR)
	#531 / 25.01		
2	(*25) UYGUR F. (TUR)	4	
3	(*28) BAO BEDNARSKI S. (SWE)	6	
	#532 / 25.01		
4	(*2) TORRES GARCIA M. (ESP)	6	
	PTS		
5	(*25) UYGUR F. (TUR)	9	(*25) UYGUR F. (TUR)
	#535 / 25.01		
6	(*28) BAO BEDNARSKI S. (SWE)	4	
7	(*16) RUSU Y. (UKR)	1	(*2) TORRES GARCIA M. (ESP)
	#536 / 25.01		
8	(*2) TORRES GARCIA M. (ESP)	6	
9	(*16) RUSU Y. (UKR)	4	(*28) BAO BEDNARSKI S. (SWE)
	#539 / 25.01		
10	(*28) BAO BEDNARSKI S. (SWE)	8	
11	(*25) UYGUR F. (TUR)	4	(*2) TORRES GARCIA M. (ESP)
	#540 / 25.01		
12	(*2) TORRES GARCIA M. (ESP)	9	

1. TORRES GARCIA MARIA (ESP)
2. UYGUR FATMA (TUR)
3. BAO BEDNARSKI SOPHIE (SWE)
4. RUSU YULIA (UKR)

1. TORRES GARCIA MARIA (ESP)
2. BERULTSEVA SOFYA (KAZ)
3. WALTERS ROCHELLE (ENG)
3. EDDARHRI MAROUA (MAR)
5. KNEER JOHANNA (GER)
5. CREEMERS INGRID (NED)
7. DANISZEWSKA JULIA (POL)
7. FERRACUTI CLIO (ITA)

*Seeded

Referees:			

Female Kumite 68+ Kg - Round Robin (each against each)

Karate1 Premier League - Paris 2025, Pierre de Coubertin Stadium, Avenue George Lafont 82, 75016 Paris, FRA

Tatami

Pool

5/8



1	(*13) KRESIC S. (BIH)	PTS	0	(*21) CREEMERS I. (NED)
	#601 / 25.01			
2	(*21) CREEMERS I. (NED)	PTS	5	
3	(*19) BONJOUR P. (SUI)	PTS	3	(*19) BONJOUR P. (SUI)
	#602 / 25.01			
4	(*23) OUDIRA C. (ALG)	PTS	1	
5	(*21) CREEMERS I. (NED)	PTS	7	(*21) CREEMERS I. (NED)
	#605 / 25.01			
6	(*19) BONJOUR P. (SUI)	PTS	1	
7	(*13) KRESIC S. (BIH)	PTS	1	(*23) OUDIRA C. (ALG)
	#606 / 25.01			
8	(*23) OUDIRA C. (ALG)	PTS	4	
9	(*13) KRESIC S. (BIH)	SEN	2	(*13) KRESIC S. (BIH)
	#609 / 25.01			
10	(*19) BONJOUR P. (SUI)	PTS	2	
11	(*21) CREEMERS I. (NED)	PTS	8	(*21) CREEMERS I. (NED)
	#610 / 25.01			
12	(*23) OUDIRA C. (ALG)	PTS	1	

1. CREEMERS INGRID (NED)
2. BONJOUR PAULINE (SUI)
3. OUDIRA CHAIMA (ALG)
4. KRESIC STEFANI (BIH)

1. TORRES GARCIA MARIA (ESP)
2. BERULTSEVA SOFYA (KAZ)
3. WALTERS ROCHELLE (ENG)
3. EDDARHRI MAROUA (MAR)
5. KNEER JOHANNA (GER)
5. CREEMERS INGRID (NED)
7. DANISZEWSKA JULIA (POL)
7. FERRACUTI CLIO (ITA)

*Seeded

Referees:			



1	(*11) LUECKE A. (GER)	#603 / 25-015	3	(*31) VAN WEZEL R. (NED)
2	(*31) VAN WEZEL R. (NED)		4	
3	(*22) GIAMOUKI T. (CYP)	#604 / 25-015	0	(*4) FERRACUTI C. (ITA)
4	(*4) FERRACUTI C. (ITA)		2	
5	(*31) VAN WEZEL R. (NED)	#607 / 25-015	2	(*22) GIAMOUKI T. (CYP)
6	(*22) GIAMOUKI T. (CYP)		7	
7	(*11) LUECKE A. (GER)	#608 / 25-015	0	(*4) FERRACUTI C. (ITA)
8	(*4) FERRACUTI C. (ITA)		2	
9	(*11) LUECKE A. (GER)	#611 / 25-015	0	(*22) GIAMOUKI T. (CYP)
10	(*22) GIAMOUKI T. (CYP)		1	
11	(*31) VAN WEZEL R. (NED)	#612 / 25-015	1	(*4) FERRACUTI C. (ITA)
12	(*4) FERRACUTI C. (ITA)		5	

1. FERRACUTI CLIO (ITA)
2. GIAMOUKI THEODOSIA (CYP)
3. VAN WEZEL ROBIN (NED)
4. LUECKE AMELIE (GER)

1. TORRES GARCIA MARIA (ESP)
2. BERULTSEVA SOFYA (KAZ)
3. WALTERS ROCHELLE (ENG)
3. EDDARHRI MAROUA (MAR)
5. KNEER JOHANNA (GER)
5. CREEMERS INGRID (NED)
7. DANISZEWSKA JULIA (POL)
7. FERRACUTI CLIO (ITA)

*Seeded

Referees:			



1	(*15) HOCAOGLU AKYOL M. (TUR)	8	(*15) HOCAOGLU AKYOL M. (TUR)
	#664 / 25.01		
2	(*32) YILDIRIM M. (GER)	3	
3	(*18) GONZALEZ LAVIN J. (CHI)	0	(*12) EDDARHRI M. (MAR)
	#665 / 25.01		
4	(*12) EDDARHRI M. (MAR)	2	
5	(*32) YILDIRIM M. (GER)	0	(*18) GONZALEZ LAVIN J. (CHI)
	#668 / 25.01		
6	(*18) GONZALEZ LAVIN J. (CHI)	4	
7	(*15) HOCAOGLU AKYOL M. (TUR)	4	(*12) EDDARHRI M. (MAR)
	#669 / 25.01		
8	(*12) EDDARHRI M. (MAR)	4	
9	(*15) HOCAOGLU AKYOL M. (TUR)	2	(*18) GONZALEZ LAVIN J. (CHI)
	#672 / 25.01		
10	(*18) GONZALEZ LAVIN J. (CHI)	7	
11	(*32) YILDIRIM M. (GER)	0	
	#673 / 25.01		
12	(*12) EDDARHRI M. (MAR)	0	

1. EDDARHRI MAROUA (MAR)
2. GONZALEZ LAVIN JAVIERA (CHI)
3. HOCAOGLU AKYOL MELTEM (TUR)
4. YILDIRIM MERYEM (GER)

1. TORRES GARCIA MARIA (ESP)
2. BERULTSEVA SOFYA (KAZ)
3. WALTERS ROCHELLE (ENG)
3. EDDARHRI MAROUA (MAR)
5. KNEER JOHANNA (GER)
5. CREEMERS INGRID (NED)
7. DANISZEWSKA JULIA (POL)
7. FERRACUTI CLIO (ITA)

*Seeded

Referees:			

Female Kumite 68+ Kg - Round Robin (each against each)

Karate1 Premier League - Paris 2025, Pierre de Coubertin Stadium, Avenue George Lafont 82, 75016 Paris, FRA

Tatami

Pool
8/8



1	(*27) ORANA F. (KOS)	
	#666 / 25.01	4 (*27) ORANA F. (KOS)
2	(*24) SULLIVAN H. (AUS)	
		1
3	(*7) KAUFMANN F. (SUI)	
	#667 / 25.01	
4	(*1) BERULTSEVA S. (KAZ)	
5	(*24) SULLIVAN H. (AUS)	
	#670 / 25.01	
6	(*7) KAUFMANN F. (SUI)	
7	(*27) ORANA F. (KOS)	
	#671 / 25.01	2 (*1) BERULTSEVA S. (KAZ)
8	(*1) BERULTSEVA S. (KAZ)	
		5
9	(*27) ORANA F. (KOS)	
	#674 / 25.01	
10	(*7) KAUFMANN F. (SUI)	
11	(*24) SULLIVAN H. (AUS)	
	#675 / 25.01	0 (*1) BERULTSEVA S. (KAZ)
12	(*1) BERULTSEVA S. (KAZ)	
		7

1. BERULTSEVA SOFYA (KAZ)
2. ORANA FORTESA (KOS)
3. SULLIVAN HANNAH (AUS)
4. KAUFMANN FABIENNE (SUI)

1. TORRES GARCIA MARIA (ESP)
2. BERULTSEVA SOFYA (KAZ)
3. WALTERS ROCHELLE (ENG)
3. EDDARHRI MAROUA (MAR)
5. KNEER JOHANNA (GER)
5. CREEMERS INGRID (NED)
7. DANISZEWSKA JULIA (POL)
7. FERRACUTI CLIO (ITA)

*Seeded

Referees:			

Pool winner-Female Kumite 68+ Kg

Karate1 Premier League - Paris 2025, Pierre de Coubertin Stadium, Avenue George Lafont 82, 75016 Paris, FRA

Tatami

Pool
1/1

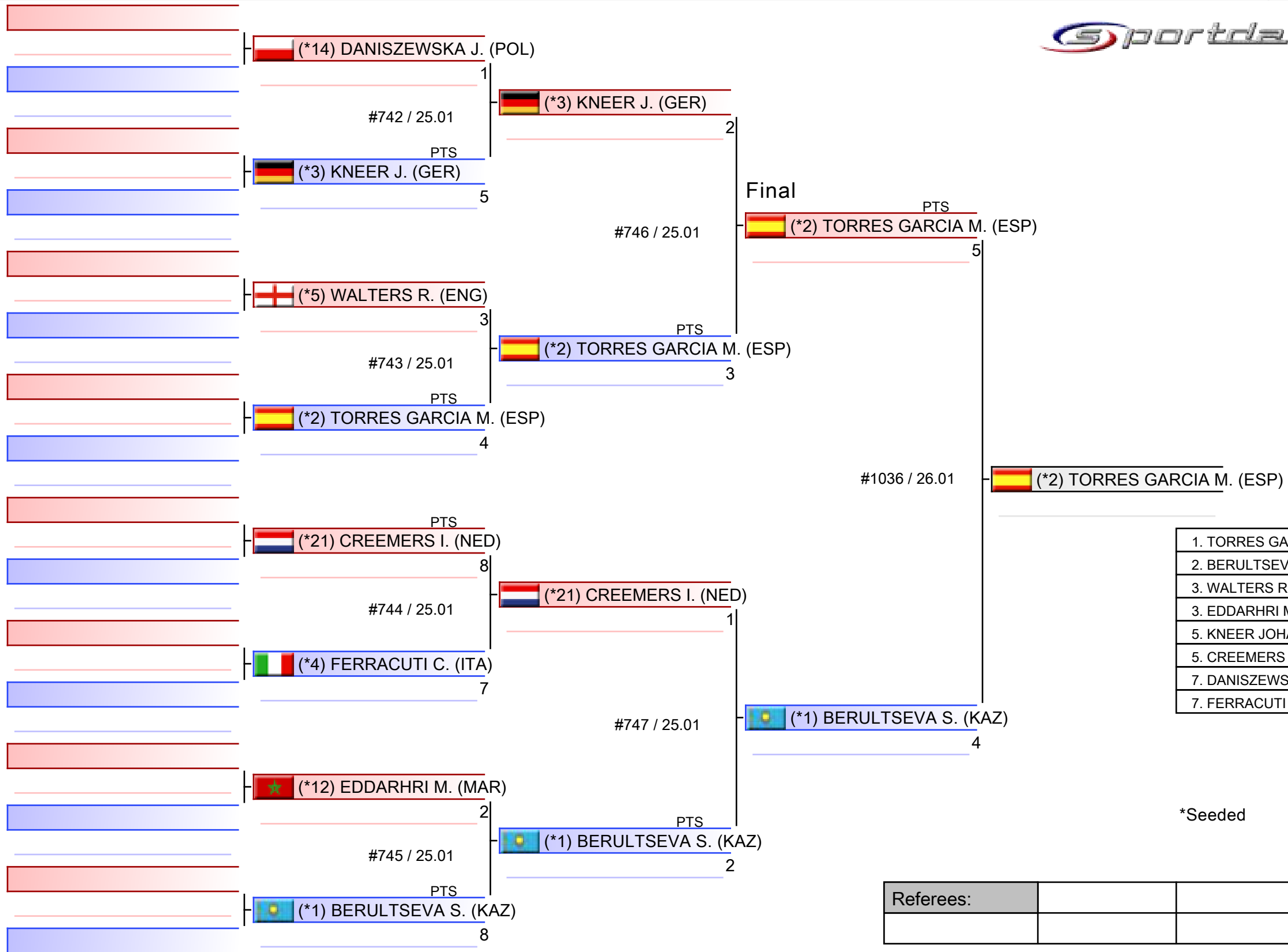

1. TORRES GARCIA MARIA (ESP)
2. BERULTSEVA SOFYA (KAZ)
3. WALTERS ROCHELLE (ENG)
3. EDDARHRI MAROUA (MAR)
5. KNEER JOHANNA (GER)
5. CREEMERS INGRID (NED)
7. DANISZEWSKA JULIA (POL)
7. FERRACUTI CLIO (ITA)

*Seeded

Referees:			

Female Kumite 68+ Kg

Karate1 Premier League - Paris 2025

Tatami

Pool

1,2,3,4,5,6,7,8

(c)sportdata GmbH & Co KG 2000-2025 (2025-01-27 23:36) v 10.2.0 build 1 (2025-01-18 23:49 CET) License: SDIL 2025 (expire 2025-12-31)

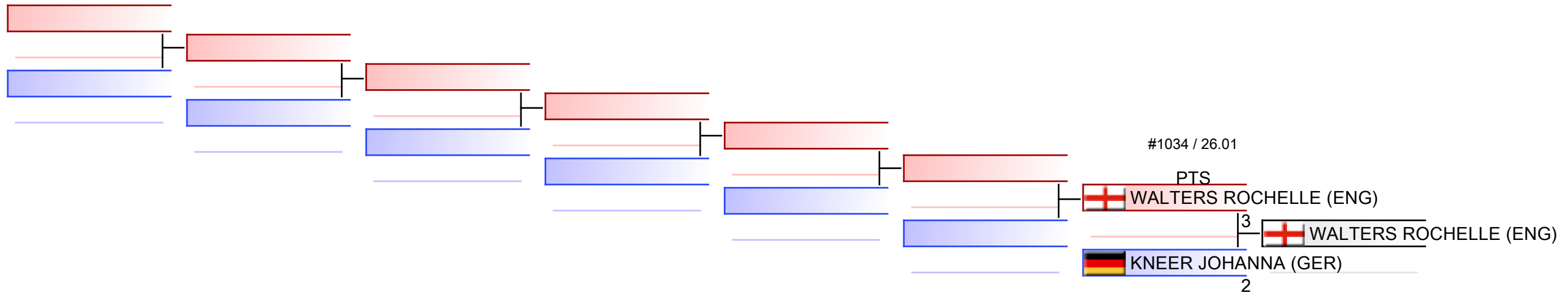

REPECHAGE: (1,2,3,4,5,6,7,8)

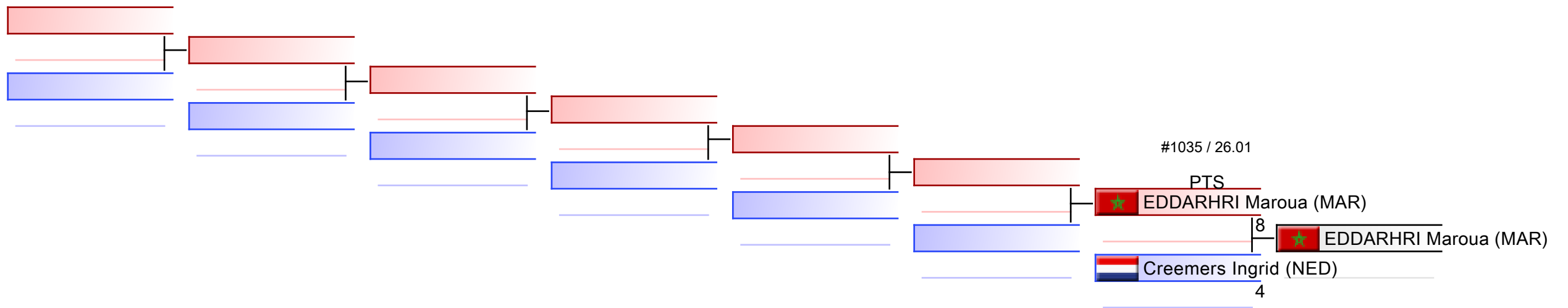

Referees:							
-----------	--	--	--	--	--	--	--

MALE KATA



Karate1 Premier League - Paris 2025

ENTRIES BY WEIGHT CATEGORY



Male Kata

As of 27 JAN 2025

Country Code	ID	Gender	Name	Seeding
ALG	ALG09842	M	BENMEKHOLOUF SABER	21
ENG	ENG2358	M	Harrison James	25
FRA	FRA04085	M	KLEMZ Thomas	18
FRA	FRA2191	M	NGOAN Franck	29
HKG	HKG162	M	Hung Ho Wai Howard	27
HUN	HUN2338	M	BARDOS ADAM	26
HUN	HUN196	M	NAGY BOTOND	20
ITA	ITA322	M	Busato Mattia	12
ITA	ITA2058	M	Gallo Gianluca	28
ITA	ITA2507	M	GHINAMI ALESSIO	7
ITA	ITA03142	M	Grazia Manuel	31
ITA	ITA327	M	Iodice Alessandro	15
JPN	JPN2278	M	Ikeda Ryusei	5
JPN	JPN2182	M	Kikuchi Ryonosuke	10
JPN	SD59454	M	MACHIDA YASUHIRO	8
JPN	JPN2058	M	Moto Kazumasa	4
JPN	JPN2290	M	Moto Ryuji	6
JPN	JPN2470	M	Nishiyama Kakeru	1
JPN	SD59618	M	Sato Yuki	24
KUW	KUW186	M	ALMOSAWI SAYED SALMAN	14
ROU	ROU2480	M	COMANESCU PETRU	22
SUI	SUI2121	M	UJIHARA YUKI	19
SVK	SVK2199	M	HRCKA ROMAN	30
SWE	SWE02584	M	VU ANTHONY	9
TUR	TUR3045	M	KOC TARIK	17
TUR	TUR2430	M	OZDEMIR ENES	11
TUR	TUR353	M	SOFUOGLU ALI	3
USA	USA2080	M	CHINEN REY	13
USA	USA283	M	TORRES GUTIERREZ ARIEL	2
USA	USA182	M	TOZAKI GAKUJI	23
VEN	VEN192	M	CASANOVA GUERRERO CLEIVER	16
VEN	VEN2329	M	Perez De Abreu Ricardo	32

Male Kata - Round Robin (each against each)

Karate1 Premier League - Paris 2025, Pierre de Coubertin Stadium, Avenue George Lafont 82, 75016 Paris, FRA

Tatami

Pool
1/8



1	(*11) OZDEMIR E. (TUR)	021 Gojushiho Sho #400 / 25.01	4180	(*11) OZDEMIR E. (TUR)
2	(*14) ALMOSAWI S. (KUW)	099 Unsu	4010	
3	(*15) IODICE A. (ITA)	021 Gojushiho Sho #401 / 25.01	3980	(*10) KIKUCHI R. (JPN)
4	(*10) KIKUCHI R. (JPN)	001 Anan	4170	
5	(*14) ALMOSAWI S. (KUW)	099 Unsu #404 / 25.01	3970	(*14) ALMOSAWI S. (KUW)
6	(*15) IODICE A. (ITA)	099 Unsu	3910	
7	(*11) OZDEMIR E. (TUR)	099 Unsu #405 / 25.01	4090	(*10) KIKUCHI R. (JPN)
8	(*10) KIKUCHI R. (JPN)	092 Suparinpei	4150	
9	(*11) OZDEMIR E. (TUR)	091 Sochin #408 / 25.01	4120	(*11) OZDEMIR E. (TUR)
10	(*15) IODICE A. (ITA)	041 Kanku Sho	3920	
11	(*14) ALMOSAWI S. (KUW)	021 Gojushiho Sho #409 / 25.01	3990	(*10) KIKUCHI R. (JPN)
12	(*10) KIKUCHI R. (JPN)	090 Shisochin	4030	

1. KIKUCHI RYONOSUKE (JPN)
2. OZDEMIR ENES (TUR)
3. ALMOSAWI SAYED SALMAN (KUW)
4. IODICE ALESSANDRO (ITA)

1. NISHIYAMA KAKERU (JPN)
2. MACHIDA YASUHIRO (JPN)
3. MOTO KAZUMASA (JPN)
3. TORRES GUTIERREZ ARIEL (USA)
5. KIKUCHI RYONOSUKE (JPN)
5. TOZAKI GAKUJI (USA)
7. MOTO RYUJI (JPN)
7. GHINAMI ALESSIO (ITA)

*Seeded

Referees:			

Male Kata - Round Robin (each against each)

Karate1 Premier League - Paris 2025, Pierre de Coubertin Stadium, Avenue George Lafont 82, 75016 Paris, FRA

Tatami

Pool
2/8



1	(*29) NGOAN F. (FRA)	021 Gojushiho Sho #402 / 25.01	3890	(*6) MOTO R. (JPN)
2	(*6) MOTO R. (JPN)	021 Gojushiho Sho	4160	
3	(*22) COMANESCU P. (ROU)	021 Gojushiho Sho #403 / 25.01	3950	(*3) SOFUOGLU A. (TUR)
4	(*3) SOFUOGLU A. (TUR)	091 Sochin	4110	
5	(*6) MOTO R. (JPN)	012 Enpi #406 / 25.01	4210	(*6) MOTO R. (JPN)
6	(*22) COMANESCU P. (ROU)	015 Gankaku	4050	
7	(*29) NGOAN F. (FRA)	099 Unsu #407 / 25.01	3980	(*3) SOFUOGLU A. (TUR)
8	(*3) SOFUOGLU A. (TUR)	060 Nijushiho	4170	
9	(*29) NGOAN F. (FRA)	041 Kanku Sho #410 / 25.01	4030	(*22) COMANESCU P. (ROU)
10	(*22) COMANESCU P. (ROU)	041 Kanku Sho	4100	
11	(*6) MOTO R. (JPN)	091 Sochin #411 / 25.01	4300	(*6) MOTO R. (JPN)
12	(*3) SOFUOGLU A. (TUR)	021 Gojushiho Sho	4180	

1. MOTO RYUJI (JPN)
2. SOFUOGLU ALI (TUR)
3. COMANESCU PETRU (ROU)
4. NGOAN FRANCK (FRA)

1. NISHIYAMA KAKERU (JPN)
2. MACHIDA YASUHIRO (JPN)
3. MOTO KAZUMASA (JPN)
3. TORRES GUTIERREZ ARIEL (USA)
5. KIKUCHI RYONOSUKE (JPN)
5. TOZAKI GAKUJI (USA)
7. MOTO RYUJI (JPN)
7. GHINAMI ALESSIO (ITA)

*Seeded

Referees:			

Male Kata - Round Robin (each against each)

Karate1 Premier League - Paris 2025, Pierre de Coubertin Stadium, Avenue George Lafont 82, 75016 Paris, FRA

Tatami

Pool
3/8



1	(*21) BENMEKHOLOUF S. (ALG)	021 Gojushiho Sho #472 / 25.01	3790	(*16) CASANOVA GUERRERO C. (VEN)
2	(*16) CASANOVA GUERRERO C. (VEN)	099 Unsu	3950	
3	(*8) MACHIDA Y. (JPN)	092 Suparinpei #473 / 25.01	4080	(*8) MACHIDA Y. (JPN)
4	(*17) KOC T. (TUR)	064 Ohan Dai	0	
5	(*16) CASANOVA GUERRERO C. (VEN)	092 Suparinpei #476 / 25.01	3830	(*8) MACHIDA Y. (JPN)
6	(*8) MACHIDA Y. (JPN)	002 Anan Dai	4040	
7	(*21) BENMEKHOLOUF S. (ALG)	099 Unsu #477 / 25.01	3820	(*17) KOC T. (TUR)
8	(*17) KOC T. (TUR)	092 Suparinpei	3920	
9	(*21) BENMEKHOLOUF S. (ALG)	020 Gojushiho Dai #480 / 25.01	3750	(*8) MACHIDA Y. (JPN)
10	(*8) MACHIDA Y. (JPN)	008 Chatanyara Kushanku	4080	
11	(*16) CASANOVA GUERRERO C. (VEN)	020 Gojushiho Dai #481 / 25.01	4000	(*17) KOC T. (TUR)
12	(*17) KOC T. (TUR)	002 Anan Dai	4010	

1. MACHIDA YASUHIRO (JPN)
2. KOC TARIK (TUR)
3. CASANOVA GUERRERO CLEIVER (VEN)
4. BENMEKHOLOUF SABER (ALG)

1. NISHIYAMA KAKERU (JPN)
2. MACHIDA YASUHIRO (JPN)
3. MOTO KAZUMASA (JPN)
3. TORRES GUTIERREZ ARIEL (USA)
5. KIKUCHI RYONOSUKE (JPN)
5. TOZAKI GAKUJI (USA)
7. MOTO RYUJI (JPN)
7. GHINAMI ALESSIO (ITA)

*Seeded

Referees:			

Male Kata - Round Robin (each against each)

Karate1 Premier League - Paris 2025, Pierre de Coubertin Stadium, Avenue George Lafont 82, 75016 Paris, FRA

Tatami

Pool
4/8



1	(*18) KLEMZ T. (FRA)	064 Ohan Dai #474 / 25.01	3920	(*18) KLEMZ T. (FRA)
2	(*28) GALLO G. (ITA)	020 Gojushiho Dai	3890	
3	(*5) IKEDA R. (JPN)	064 Ohan Dai #475 / 25.01	3990	(*2) TORRES GUTIERREZ A. (USA)
4	(*2) TORRES GUTIERREZ A. (USA)	064 Ohan Dai	4100	
5	(*28) GALLO G. (ITA)	021 Gojushiho Sho #478 / 25.01	3900	(*5) IKEDA R. (JPN)
6	(*5) IKEDA R. (JPN)	063 Ohan	4020	
7	(*18) KLEMZ T. (FRA)	092 Suparinpei #479 / 25.01	3850	(*2) TORRES GUTIERREZ A. (USA)
8	(*2) TORRES GUTIERREZ A. (USA)	047 Kururunfa	4120	
9	(*18) KLEMZ T. (FRA)	068 Papuren #482 / 25.01	3890	(*5) IKEDA R. (JPN)
10	(*5) IKEDA R. (JPN)	002 Anan Dai	4140	
11	(*28) GALLO G. (ITA)	099 Unsu #483 / 25.01	3980	(*2) TORRES GUTIERREZ A. (USA)
12	(*2) TORRES GUTIERREZ A. (USA)	090 Shisochin	4140	

1. TORRES GUTIERREZ ARIEL (USA)
2. IKEDA RYUSEI (JPN)
3. KLEMZ THOMAS (FRA)
4. GALLO GIANLUCA (ITA)

1. NISHIYAMA KAKERU (JPN)
2. MACHIDA YASUHIRO (JPN)
3. MOTO KAZUMASA (JPN)
3. TORRES GUTIERREZ ARIEL (USA)
5. KIKUCHI RYONOSUKE (JPN)
5. TOZAKI GAKUJI (USA)
7. MOTO RYUJI (JPN)
7. GHINAMI ALESSIO (ITA)

*Seeded

Referees:			

Male Kata - Round Robin (each against each)

Karate1 Premier League - Paris 2025, Pierre de Coubertin Stadium, Avenue George Lafont 82, 75016 Paris, FRA

Tatami

Pool
5/8



1	(*25) HARRISON J. (ENG)	002 Anan Dai #541 / 25.01	3900	(*32) PEREZ DE ABREU R. (VEN)	000
2	(*32) PEREZ DE ABREU R. (VEN)	064 Ohan Dai	4050		
3	(*30) HRCKA R. (SVK)	009 Chibana No Kushanku #542 / 25.01	4020	(*7) GHINAMI A. (ITA)	020
4	(*7) GHINAMI A. (ITA)	020 Gojushiho Dai	4180		
5	(*32) PEREZ DE ABREU R. (VEN)	092 Suparinpei #545 / 25.01	4020	(*30) HRCKA R. (SVK)	020
6	(*30) HRCKA R. (SVK)	061 Nipaipo	4060		
7	(*25) HARRISON J. (ENG)	047 Kururunfa #546 / 25.01	3970	(*7) GHINAMI A. (ITA)	070
8	(*7) GHINAMI A. (ITA)	021 Gojushiho Sho	4120		
9	(*25) HARRISON J. (ENG)	068 Papuren #549 / 25.01	4020	(*30) HRCKA R. (SVK)	020
10	(*30) HRCKA R. (SVK)	068 Papuren	4140		
11	(*32) PEREZ DE ABREU R. (VEN)	009 Chibana No Kushanku #550 / 25.01	3970	(*7) GHINAMI A. (ITA)	070
12	(*7) GHINAMI A. (ITA)	099 Unsu	4180		

1. GHINAMI ALESSIO (ITA)
2. HRCKA ROMAN (SVK)
3. PEREZ DE ABREU RICARDO (VEN)
4. HARRISON JAMES (ENG)

1. NISHIYAMA KAKERU (JPN)
2. MACHIDA YASUHIRO (JPN)
3. MOTO KAZUMASA (JPN)
3. TORRES GUTIERREZ ARIEL (USA)
5. KIKUCHI RYONOSUKE (JPN)
5. TOZAKI GAKUJI (USA)
7. MOTO RYUJI (JPN)
7. GHINAMI ALESSIO (ITA)

*Seeded

Referees:			

Male Kata - Round Robin (each against each)

Karate1 Premier League - Paris 2025, Pierre de Coubertin Stadium, Avenue George Lafont 82, 75016 Paris, FRA

Tatami

Pool
6/8



1	(*20) NAGY B. (HUN)	002 Anan Dai #543 / 25.01	3990	(*20) NAGY B. (HUN)
2	(*13) CHINEN R. (USA)	002 Anan Dai	3950	
3	(*31) GRAZIA M. (ITA)	063 Ohan #544 / 25.01	3980	(*4) MOTO K. (JPN)
4	(*4) MOTO K. (JPN)	091 Sochin	4170	
5	(*13) CHINEN R. (USA)	047 Kururunfa #547 / 25.01	4010	(*31) GRAZIA M. (ITA)
6	(*31) GRAZIA M. (ITA)	002 Anan Dai	4020	
7	(*20) NAGY B. (HUN)	064 Ohan Dai #548 / 25.01	4040	(*4) MOTO K. (JPN)
8	(*4) MOTO K. (JPN)	020 Gojushiho Dai	4160	
9	(*20) NAGY B. (HUN)	068 Papuren #551 / 25.01	3980	(*20) NAGY B. (HUN)
10	(*31) GRAZIA M. (ITA)	064 Ohan Dai	3970	
11	(*13) CHINEN R. (USA)	092 Suparinpei #552 / 25.01	3980	(*4) MOTO K. (JPN)
12	(*4) MOTO K. (JPN)	099 Unsu	4180	

1. MOTO KAZUMASA (JPN)
2. NAGY BOTOND (HUN)
3. GRAZIA MANUEL (ITA)
4. CHINEN REY (USA)

1. NISHIYAMA KAKERU (JPN)
2. MACHIDA YASUHIRO (JPN)
3. MOTO KAZUMASA (JPN)
3. TORRES GUTIERREZ ARIEL (USA)
5. KIKUCHI RYONOSUKE (JPN)
5. TOZAKI GAKUJI (USA)
7. MOTO RYUJI (JPN)
7. GHINAMI ALESSIO (ITA)

*Seeded

Referees:			

Male Kata - Round Robin (each against each)

Karate1 Premier League - Paris 2025, Pierre de Coubertin Stadium, Avenue George Lafont 82, 75016 Paris, FRA

Tatami

Pool

7/8



1	(*27) HUNG H. (HKG)	092 Suparinpei #613 / 25.01	3880	(*27) HUNG H. (HKG)
2	(*26) BARDOS A. (HUN)	068 Papuren	3760	
3	(*23) TOZAKI G. (USA)	002 Anan Dai #614 / 25.01	3980	(*23) TOZAKI G. (USA)
4	(*24) SATO Y. (JPN)	092 Suparinpei	3980	
5	(*26) BARDOS A. (HUN)	009 Chibana No Kushanku #617 / 25.01	3940	(*23) TOZAKI G. (USA)
6	(*23) TOZAKI G. (USA)	001 Anan	4160	
7	(*27) HUNG H. (HKG)	064 Ohan Dai #618 / 25.01	3940	(*24) SATO Y. (JPN)
8	(*24) SATO Y. (JPN)	001 Anan	4080	
9	(*27) HUNG H. (HKG)	009 Chibana No Kushanku #621 / 25.01	3930	(*23) TOZAKI G. (USA)
10	(*23) TOZAKI G. (USA)	064 Ohan Dai	4100	
11	(*26) BARDOS A. (HUN)	092 Suparinpei #622 / 25.01	3870	(*24) SATO Y. (JPN)
12	(*24) SATO Y. (JPN)	068 Papuren	4030	

1. TOZAKI GAKUJI (USA)
2. SATO YUKI (JPN)
3. HUNG HO WAI HOWARD (HKG)
4. BARDOS ADAM (HUN)

1. NISHIYAMA KAKERU (JPN)
2. MACHIDA YASUHIRO (JPN)
3. MOTO KAZUMASA (JPN)
3. TORRES GUTIERREZ ARIEL (USA)
5. KIKUCHI RYONOSUKE (JPN)
5. TOZAKI GAKUJI (USA)
7. MOTO RYUJI (JPN)
7. GHINAMI ALESSIO (ITA)

*Seeded

Referees:			

Male Kata - Round Robin (each against each)

Karate1 Premier League - Paris 2025, Pierre de Coubertin Stadium, Avenue George Lafont 82, 75016 Paris, FRA

Tatami

Pool
8/8



1	(*12) BUSATO M. (ITA)	099 Unsu #615 / 25.01	4120	(*12) BUSATO M. (ITA)
2	(*19) UJIHARA Y. (SUI)	092 Suparinpei	3930	
3	(*9) VU A. (SWE)	002 Anan Dai #616 / 25.01	4020	(*1) NISHIYAMA K. (JPN)
4	(*1) NISHIYAMA K. (JPN)	086 Seisan	4220	
5	(*19) UJIHARA Y. (SUI)	068 Papuren #619 / 25.01	3950	(*9) VU A. (SWE)
6	(*9) VU A. (SWE)	009 Chibana No Kushanku	4090	
7	(*12) BUSATO M. (ITA)	021 Gojushiho Sho #620 / 25.01	4110	(*1) NISHIYAMA K. (JPN)
8	(*1) NISHIYAMA K. (JPN)	090 Shisochin	4230	
9	(*12) BUSATO M. (ITA)	041 Kanku Sho #623 / 25.01	4080	(*9) VU A. (SWE)
10	(*9) VU A. (SWE)	064 Ohan Dai	4120	
11	(*19) UJIHARA Y. (SUI)	047 Kururunfa #624 / 25.01	3850	(*1) NISHIYAMA K. (JPN)
12	(*1) NISHIYAMA K. (JPN)	047 Kururunfa	4220	

1. NISHIYAMA KAKERU (JPN)
2. VU ANTHONY (SWE)
3. BUSATO MATTIA (ITA)
4. UJIHARA YUKI (SUI)

1. NISHIYAMA KAKERU (JPN)
2. MACHIDA YASUHIRO (JPN)
3. MOTO KAZUMASA (JPN)
3. TORRES GUTIERREZ ARIEL (USA)
5. KIKUCHI RYONOSUKE (JPN)
5. TOZAKI GAKUJI (USA)
7. MOTO RYUJI (JPN)
7. GHINAMI ALESSIO (ITA)

*Seeded

Referees:			

Pool winner-Male Kata

Karate1 Premier League - Paris 2025, Pierre de Coubertin Stadium, Avenue George Lafont 82, 75016 Paris, FRA

Tatami

Pool
1/1

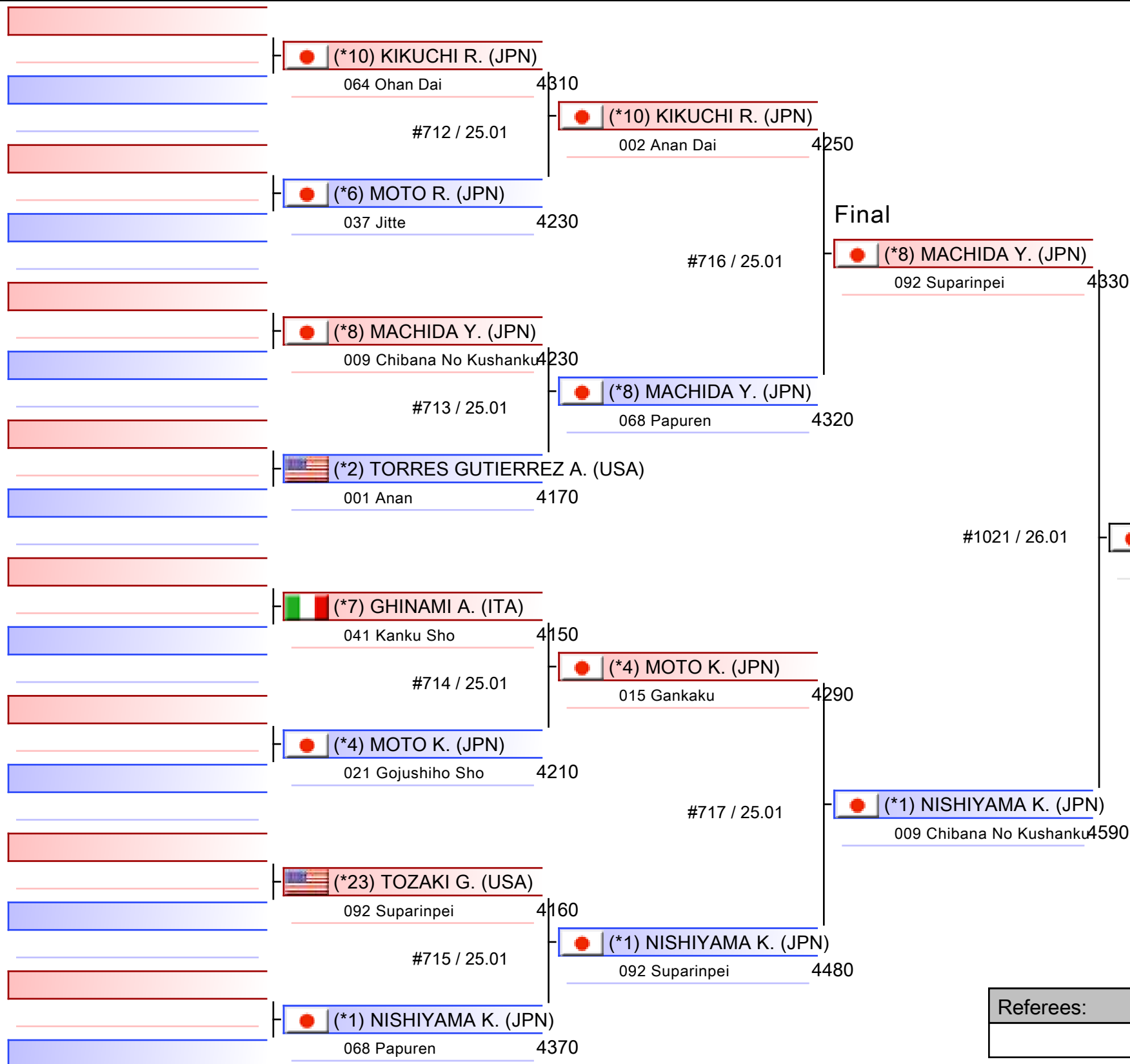

1. NISHIYAMA KAKERU (JPN)
2. MACHIDA YASUHIRO (JPN)
3. MOTO KAZUMASA (JPN)
3. TORRES GUTIERREZ ARIEL (USA)
5. KIKUCHI RYONOSUKE (JPN)
5. TOZAKI GAKUJI (USA)
7. MOTO RYUJI (JPN)
7. GHINAMI ALESSIO (ITA)

*Seeded

Referees:			

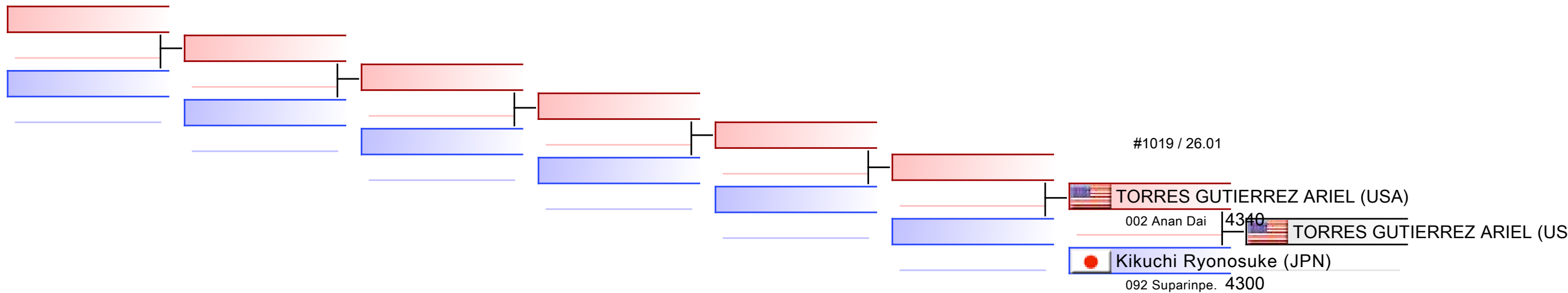

REPECHAGE: (1,2,3,4,5,6,7,8)

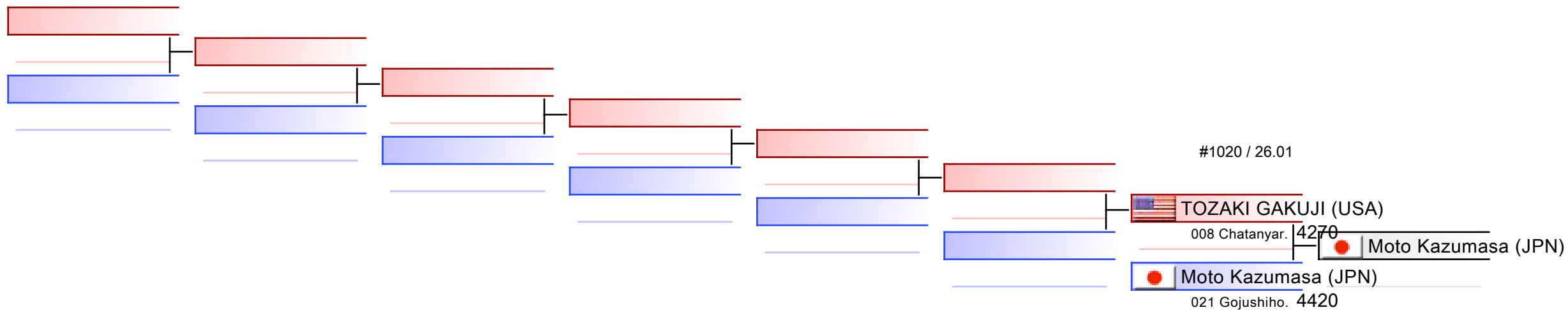

Referees:							
-----------	--	--	--	--	--	--	--

MALE KUMITE -60 KG



Karate1 Premier League - Paris 2025

ENTRIES BY WEIGHT CATEGORY



Male Kumite -60 Kg

As of 27 JAN 2025

Country Code	ID	Gender	Name	Seeding
ALB	ALB2002	M	ARIFI ORGES	11
BEL	BEL2201	M	ABDELMALKI ANASS	8
BEL	BEL226	M	Dasoul Michael	21
CHI	CHI2062	M	VILLALON RUIZ ENRIQUE	26
COL	COL02565	M	FORERO JUAN DAVID	9
EGY	EGY2635	M	Aboukora Amr Alaa	13
EGY	EGY2208	M	Aly Zyad	31
FRA	FRA02768	M	HELLAL Amine	23
FRA	FRA02889	M	MEZIANE RAYYAN	12
FRA	FRA03559	M	TAS SAMI	30
GEO	GEO154	M	Tkebuchava David	28
GER	GER2184	M	HAAS FLORIAN	20
GER	GER03121	M	OBITZ FLORIAN	17
GRE	GRE377	M	KARALIS GEORGIOS	18
GRE	GRE521	M	XENOS CHRISTOS-STEFANOS	3
IRI	IRI2143	M	Meskini Ali	29
ITA	ITA266	M	CRESCENZO Angelo	7
ITA	ITA2137	M	GRECO DANILO	10
ITA	ITA2509	M	Luciano Carmine	15
ITA	ITA03865	M	Sabatino Christian	24
JOR	JOR2161	M	Shaqrah Omar	27
JPN	JPN03258	M	HASHIMOTO HIROMU	1
JPN	SD63542	M	yatoji yoshihito	16
KAZ	KAZ2006	M	ALPYSBAY KAISAR	5
KSA	KSA03353	M	ALARIANI ALI	25
KUW	KUW188	M	SHAABAN ABDULLAH	2
ROU	ROU267	M	GOGOLOSI BOGDAN MARIAN FLORIN	14
THA	THA2221	M	MUEKTHONG SIWAKON	22
TUR	TUR2663	M	HALICI MERT	6
TUR	TUR675	M	OZDEMIR BURAK	19
TUR	TUR632	M	SAMDAN ERAY	4

Male Kumite -60 Kg - Round Robin (each against each)

Karate1 Premier League - Paris 2025, Pierre de Coubertin Stadium, Avenue George Lafont 82, 75016 Paris, FRA

Tatami

Pool
1/8



1	(*11) ARIFI O. (ALB)	PTS	1	(*11) ARIFI O. (ALB)
	#13 / 24.01			
2	(*14) GOGOLOSI B. (ROU)	PTS	1	
3	(*12) MEZIANE R. (FRA)	PTS	2	(*12) MEZIANE R. (FRA)
	#14 / 24.01			
4	(*7) CRESCENZO A. (ITA)	PTS	2	
5	(*14) GOGOLOSI B. (ROU)	PTS	0	(*12) MEZIANE R. (FRA)
	#17 / 24.01			
6	(*12) MEZIANE R. (FRA)	PTS	2	
7	(*11) ARIFI O. (ALB)	PTS	0	(*7) CRESCENZO A. (ITA)
	#18 / 24.01			
8	(*7) CRESCENZO A. (ITA)	PTS	2	
9	(*11) ARIFI O. (ALB)	PTS	5	(*11) ARIFI O. (ALB)
	#21 / 24.01			
10	(*12) MEZIANE R. (FRA)	PTS	3	
11	(*14) GOGOLOSI B. (ROU)	PTS	2	
	#22 / 24.01			
12	(*7) CRESCENZO A. (ITA)	PTS	2	

1. ARIFI ORGES (ALB)
2. MEZIANE RAYYAN (FRA)
3. CRESCENZO ANGELO (ITA)
4. GOGOLOSI BOGDAN MARIAN FLORIN (ROU)

1. SAMDAN ERAY (TUR)
2. XENOS CHRISTOS-STEFANOS (GRE)
3. ALPYSBAY KAISAR (KAZ)
3. MESKINI ALI (IRI)
5. ARIFI ORGES (ALB)
5. HASHIMOTO HIROMU (JPN)
7. ALY ZYAD (EGY)
7. TAS SAMI (FRA)

*Seeded

Referees:			

Male Kumite -60 Kg - Round Robin (each against each)

Karate1 Premier League - Paris 2025, Pierre de Coubertin Stadium, Avenue George Lafont 82, 75016 Paris, FRA

Tatami

Pool
2/8



1	(*22) MUEKTHONG S. (THA)	5	(*22) MUEKTHONG S. (THA)
	#15 / 24.01		
2	(*6) HALICI M. (TUR)	4	
3	(*23) HELLAL A. (FRA)	2	(*3) XENOS C. (GRE)
	#16 / 24.01		
4	(*3) XENOS C. (GRE)	3	
5	(*6) HALICI M. (TUR)	4	(*23) HELLAL A. (FRA)
	#19 / 24.01		
6	(*23) HELLAL A. (FRA)	5	
7	(*22) MUEKTHONG S. (THA)	0	(*3) XENOS C. (GRE)
	#20 / 24.01		
8	(*3) XENOS C. (GRE)	6	
9	(*22) MUEKTHONG S. (THA)	0	(*23) HELLAL A. (FRA)
	#23 / 24.01		
10	(*23) HELLAL A. (FRA)	1	
11	(*6) HALICI M. (TUR)	0	(*3) XENOS C. (GRE)
	#24 / 24.01		
12	(*3) XENOS C. (GRE)	4	

1. XENOS CHRISTOS-STEFANOS (GRE)
2. HELLAL AMINE (FRA)
3. MUEKTHONG SIWAKON (THA)
4. HALICI MERT (TUR)

1. SAMDAN ERAY (TUR)
2. XENOS CHRISTOS-STEFANOS (GRE)
3. ALPYSBAY KAISAR (KAZ)
3. MESKINI ALI (IRI)
5. ARIFI ORGES (ALB)
5. HASHIMOTO HIROMU (JPN)
7. ALY ZYAD (EGY)
7. TAS SAMI (FRA)

*Seeded

Referees:			

Male Kumite -60 Kg - Round Robin (each against each)

Karate1 Premier League - Paris 2025, Pierre de Coubertin Stadium, Avenue George Lafont 82, 75016 Paris, FRA

Tatami

Pool
3/8



1	(*29) MESKINI A. (IRI)	
	#85 / 24.01	5 (*29) MESKINI A. (IRI)
2	(*13) ABOUKORA A. (EGY)	
	PTS	1
3	(*15) LUCIANO C. (ITA)	
	#86 / 24.01	5 (*15) LUCIANO C. (ITA)
4	(*8) ABDELMALKI A. (BEL)	
	PTS	0
5	(*13) ABOUKORA A. (EGY)	
	#89 / 24.01	1 (*15) LUCIANO C. (ITA)
6	(*15) LUCIANO C. (ITA)	
	PTS	2
7	(*29) MESKINI A. (IRI)	
	#90 / 24.01	4 (*29) MESKINI A. (IRI)
8	(*8) ABDELMALKI A. (BEL)	
	PTS	1
9	(*29) MESKINI A. (IRI)	
	#93 / 24.01	3 (*29) MESKINI A. (IRI)
10	(*15) LUCIANO C. (ITA)	
	PTS	0
11	(*13) ABOUKORA A. (EGY)	
	#94 / 24.01	2 (*13) ABOUKORA A. (EGY)
12	(*8) ABDELMALKI A. (BEL)	
	PTS	0

1. MESKINI ALI (IRI)
2. LUCIANO CARMINE (ITA)
3. ABOUKORA AMR ALAA (EGY)
4. ABDELMALKI ANASS (BEL)

1. SAMDAN ERAY (TUR)
2. XENOS CHRISTOS-STEFANOS (GRE)
3. ALPYSBAY KAISAR (KAZ)
3. MESKINI ALI (IRI)
5. ARIFI ORGES (ALB)
5. HASHIMOTO HIROMU (JPN)
7. ALY ZYAD (EGY)
7. TAS SAMI (FRA)

*Seeded

Referees:			

Male Kumite -60 Kg - Round Robin (each against each)

Karate1 Premier League - Paris 2025, Pierre de Coubertin Stadium, Avenue George Lafont 82, 75016 Paris, FRA

Tatami

Pool
4/8



1. ALY ZYAD (EGY)
2. VILLALON RUIZ ENRIQUE (CHI)
3. GRECO DANILO (ITA)
4. SHAABAN ABDULLAH (KUW)

1. SAMDAN ERAY (TUR)
2. XENOS CHRISTOS-STEFANOS (GRE)
3. ALPYSBAY KAISAR (KAZ)
3. MESKINI ALI (IRI)
5. ARIFI ORGES (ALB)
5. HASHIMOTO HIROMU (JPN)
7. ALY ZYAD (EGY)
7. TAS SAMI (FRA)

*Seeded

Referees:			

Male Kumite -60 Kg - Round Robin (each against each)

Karate1 Premier League - Paris 2025, Pierre de Coubertin Stadium, Avenue George Lafont 82, 75016 Paris, FRA

Tatami

Pool
5/8

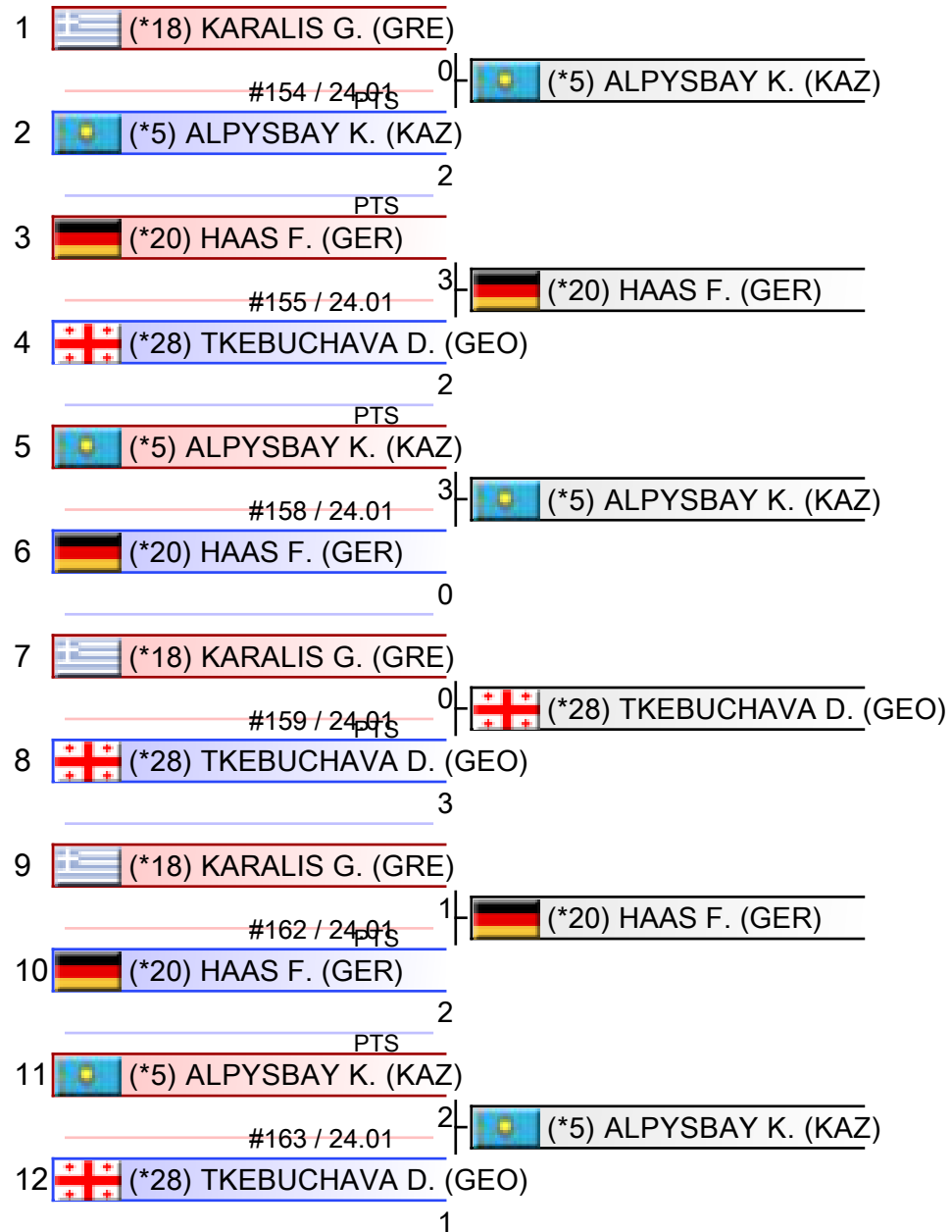

1. ALPYSBAY KAISAR (KAZ)
2. HAAS FLORIAN (GER)
3. TKEBUCHAVA DAVID (GEO)
4. KARALIS GEORGIOS (GRE)

1. SAMDAN ERAY (TUR)
2. XENOS CHRISTOS-STEFANOS (GRE)
3. ALPYSBAY KAISAR (KAZ)
3. MESKINI ALI (IRI)
5. ARIFI ORGES (ALB)
5. HASHIMOTO HIROMU (JPN)
7. ALY ZYAD (EGY)
7. TAS SAMI (FRA)

*Seeded

Referees:			

Male Kumite -60 Kg - Round Robin (each against each)

Karate1 Premier League - Paris 2025, Pierre de Coubertin Stadium, Avenue George Lafont 82, 75016 Paris, FRA

Tatami

Pool
6/8



1	(*25) ALARIANI A. (KSA)	0	(*16) YATOJI Y. (JPN)
	#156 / 24.01		
2	(*16) YATOJI Y. (JPN)	2	
3	(*17) OBITZ F. (GER)	0	(*4) SAMDAN E. (TUR)
	#157 / 24.01		
4	(*4) SAMDAN E. (TUR)	4	
	PTS		
5	(*16) YATOJI Y. (JPN)	1	(*16) YATOJI Y. (JPN)
	#160 / 24.01		
6	(*17) OBITZ F. (GER)	0	
7	(*25) ALARIANI A. (KSA)	0	(*4) SAMDAN E. (TUR)
	#161 / 24.01		
8	(*4) SAMDAN E. (TUR)	4	
9	(*25) ALARIANI A. (KSA)	1	(*17) OBITZ F. (GER)
	#164 / 24.01		
10	(*17) OBITZ F. (GER)	3	
11	(*16) YATOJI Y. (JPN)	2	(*4) SAMDAN E. (TUR)
	#165 / 24.01		
12	(*4) SAMDAN E. (TUR)	3	

1. SAMDAN ERAY (TUR)
2. YATOJI YOSHIHITO (JPN)
3. OBITZ FLORIAN (GER)
4. ALARIANI ALI (KSA)

1. SAMDAN ERAY (TUR)
2. XENOS CHRISTOS-STEFANOS (GRE)
3. ALPYSBAY KAISAR (KAZ)
3. MESKINI ALI (IRI)
5. ARIFI ORGES (ALB)
5. HASHIMOTO HIROMU (JPN)
7. ALY ZYAD (EGY)
7. TAS SAMI (FRA)

*Seeded

Referees:			

Male Kumite -60 Kg - Round Robin (each against each)

Karate1 Premier League - Paris 2025, Pierre de Coubertin Stadium, Avenue George Lafont 82, 75016 Paris, FRA

Tatami

Pool
7/8



1	(*9) FORERO J. (COL)	3	(*9) FORERO J. (COL)
	#226 / 24.01		
2	(*21) DASOUL M. (BEL)	1	
	PTS		
3	(*19) OZDEMIR B. (TUR)	5	(*19) OZDEMIR B. (TUR)
	#227 / 24.01		
4	(*30) TAS S. (FRA)	0	
5	(*21) DASOUL M. (BEL)	1	(*19) OZDEMIR B. (TUR)
	#229 / 24.01		
6	(*19) OZDEMIR B. (TUR)	5	
7	(*9) FORERO J. (COL)	0	(*30) TAS S. (FRA)
	#230 / 24.01		
8	(*30) TAS S. (FRA)	7	
	PTS		
9	(*9) FORERO J. (COL)	4	(*9) FORERO J. (COL)
	#232 / 24.01		
10	(*19) OZDEMIR B. (TUR)	1	
11	(*21) DASOUL M. (BEL)	0	(*30) TAS S. (FRA)
	#233 / 24.01		
12	(*30) TAS S. (FRA)	5	

1. TAS SAMI (FRA)
2. FORERO JUAN DAVID (COL)
3. OZDEMIR BURAK (TUR)
4. DASOUL MICHAEL (BEL)

1. SAMDAN ERAY (TUR)
2. XENOS CHRISTOS-STEFANOS (GRE)
3. ALPYSBAY KAISAR (KAZ)
3. MESKINI ALI (IRI)
5. ARIFI ORGES (ALB)
5. HASHIMOTO HIROMU (JPN)
7. ALY ZYAD (EGY)
7. TAS SAMI (FRA)

*Seeded

Referees:			

Male Kumite -60 Kg - Round Robin (each against each)

Karate1 Premier League - Paris 2025, Pierre de Coubertin Stadium, Avenue George Lafont 82, 75016 Paris, FRA

Tatami

Pool
8/8



1	(*27) SHAQRAH O. (JOR)	4	(*27) SHAQRAH O. (JOR)
	#228 / 24.01		
2	(*24) SABATINO C. (ITA)	3	
3	(*27) SHAQRAH O. (JOR)	0	(*1) HASHIMOTO H. (JPN)
	#234 / 24.01		
4	(*1) HASHIMOTO H. (JPN)	5	
5	(*24) SABATINO C. (ITA)	0	(*1) HASHIMOTO H. (JPN)
	#231 / 24.01		
6	(*1) HASHIMOTO H. (JPN)	4	

1. HASHIMOTO HIROMU (JPN)
2. SHAQRAH OMAR (JOR)
3. SABATINO CHRISTIAN (ITA)

1. SAMDAN ERAY (TUR)
2. XENOS CHRISTOS-STEFANOS (GRE)
3. ALPYSBAY KAISAR (KAZ)
3. MESKINI ALI (IRI)
5. ARIFI ORGES (ALB)
5. HASHIMOTO HIROMU (JPN)
7. ALY ZYAD (EGY)
7. TAS SAMI (FRA)

*Seeded

Referees:			

Pool winner-Male Kumite -60 Kg

Karate1 Premier League - Paris 2025, Pierre de Coubertin Stadium, Avenue George Lafont 82, 75016 Paris, FRA

Tatami

Pool
1/1

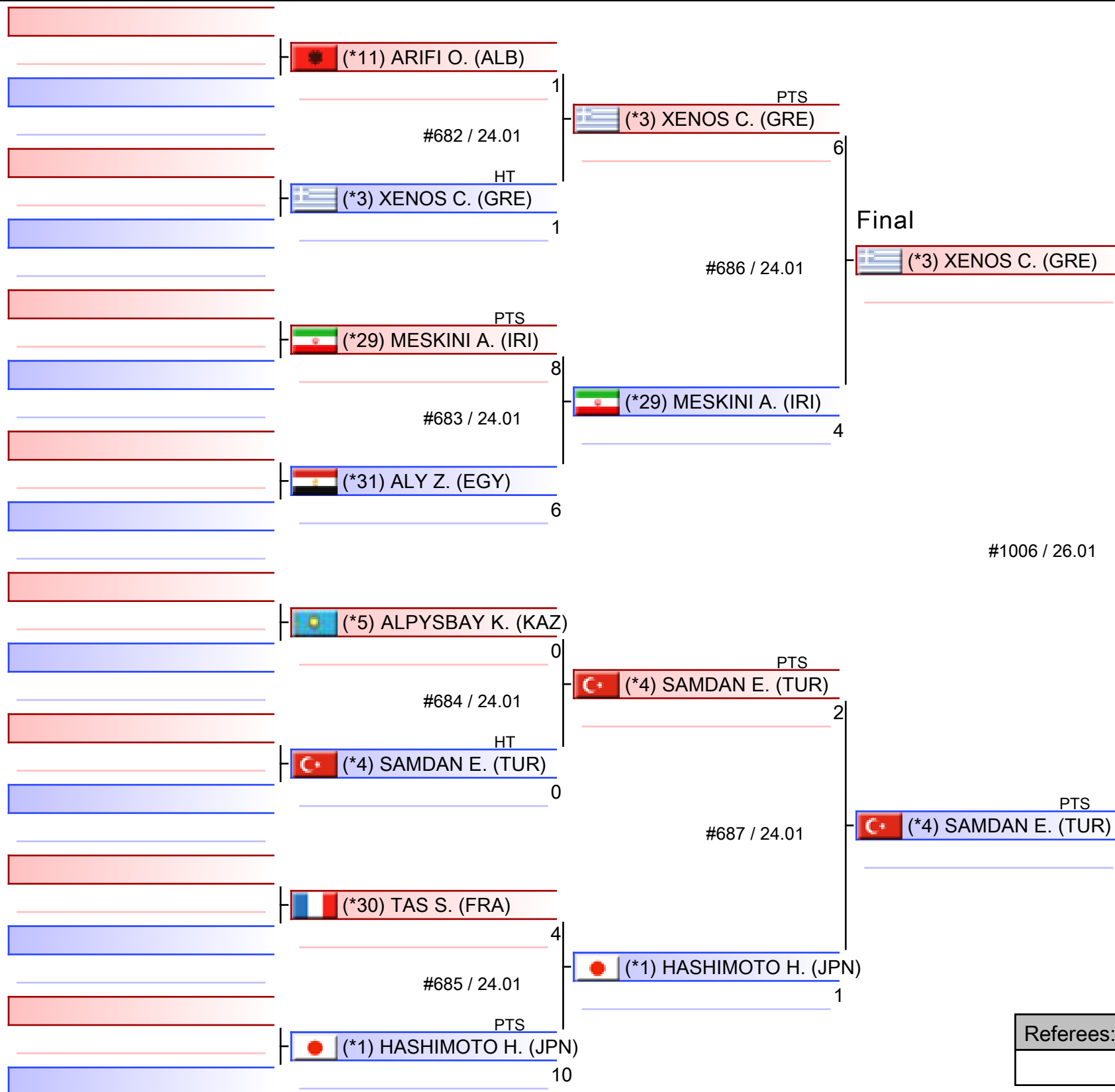

1. SAMDAN ERAY (TUR)
2. XENOS CHRISTOS-STEFANOS (GRE)
3. ALPYSBAY KAISAR (KAZ)
3. MESKINI ALI (IRI)
5. ARIFI ORGES (ALB)
5. HASHIMOTO HIROMU (JPN)
7. ALY ZYAD (EGY)
7. TAS SAMI (FRA)

*Seeded

Referees:			

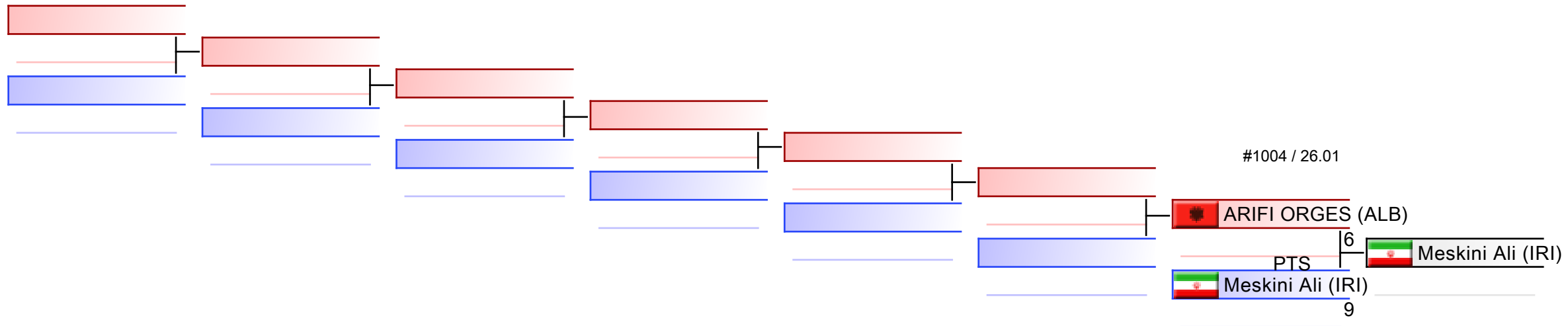

REPECHAGE: (1,2,3,4,5,6,7,8)

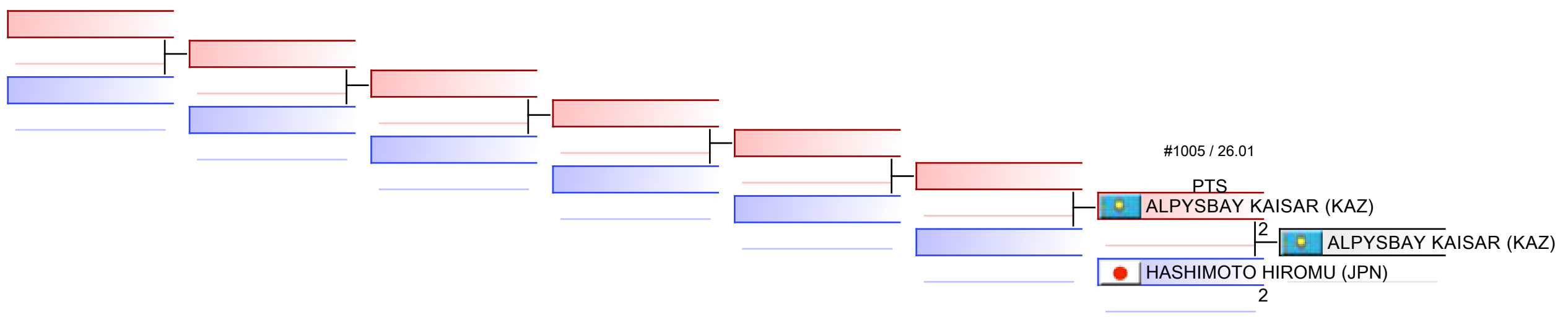

Referees:							
-----------	--	--	--	--	--	--	--

MALE KUMITE -67 KG



Karate1 Premier League - Paris 2025

ENTRIES BY WEIGHT CATEGORY



Male Kumite -67 Kg

As of 27 JAN 2025

Country Code	ID	Gender	Name	Seeding
ALG	ALG02552	M	AYOUB ANIS HALASSA	10
AZE	AZE02341	M	RZAZADE NURAN	14
BEL	BEL2030	M	OUALAD HAJ AMAR YOUNESS	23
BRA	BRA299	M	FIGUEIRA VINICIUS	3
CHI	CHI2097	M	FREIRE FUENTES TOMAS	9
EGY	EGY319	M	Elsawy Ali	15
ENG	ENG2372	M	Wilson Joby	29
FRA	SD65094	M	Salmi Younesse	21
FRA	FRA03560	M	TAS YANIS	17
GER	GER2584	M	OEZDEMIR MUHAMMED	7
GRE	GRE02321	M	BALLOTIS GEORGIOS	20
IRI	IRI03111	M	Borzoeichaghgolani Amirreza	30
IRL	IRL2137	M	O SULLIVAN CONOR	22
ITA	ITA04245	M	Astarita Raffaele	24
ITA	ITA259	M	De Vivo Gianluca	13
ITA	ITA329	M	Maresca Luca	4
ITA	ITA2511	M	Ruggiero Rosario	26
JOR	JOR2159	M	GHAITH AFEEF	5
JPN	JPN2077	M	Kozaki Yugo	2
LAT	LAT2084	M	STEPANOV ARTUR	18
MAR	MAR2271	M	OUBAYA SAID	1
POR	POR2265	M	Duarte Rafael	25
POR	POR2170	M	MENDES JOAQUIM	8
POR	POR2086	M	NUNES RIBEIRO DIOGO MIGUEL	16
ROU	ROU2273	M	BAICU ORLANDO	28
SVK	SVK296	M	HOMOLA MATEJ	11
TPE	TPE2046	M	SHIH CHENG-CHUNG	12
TUN	TUN02791	M	HADDAJI LAITH	27
TUR	TUR2050	M	OZER OMER ABDURRAHIM	6
UKR	UKR2368	M	YANOVSKYI DAVYD	19

Male Kumite -67 Kg - Round Robin (each against each)

Karate1 Premier League - Paris 2025, Pierre de Coubertin Stadium, Avenue George Lafont 82, 75016 Paris, FRA

Tatami

Pool
1/8



1. YANOVSKYI DAVYD (UKR)
2. ELSAWY ALI (EGY)
3. RUGGIERO ROSARIO (ITA)
4. MENDES JOAQUIM (POR)

1. KOZAKI YUGO (JPN)
2. OZER OMER ABDURRAHIM (TUR)
3. FIGUEIRA VINICIUS (BRA)
3. BALIOTIS GEORGIOS (GRE)
5. DE VIVO GIANLUCA (ITA)
5. RZAZADE NURAN (AZE)
7. YANOVSKYI DAVYD (UKR)
7. MARESCA LUCA (ITA)

*Seeded

Referees:			

Male Kumite -67 Kg - Round Robin (each against each)

Karate1 Premier League - Paris 2025, Pierre de Coubertin Stadium, Avenue George Lafont 82, 75016 Paris, FRA

Tatami

Pool
2/8



1	(*10) AYOUB ANIS H. (ALG)	PTS	#39 / 24.01	0	(*24) ASTARITA R. (ITA)
2	(*24) ASTARITA R. (ITA)	PTS		2	
3	(*27) HADDAJI L. (TUN)	PTS	#40 / 24.01	5	(*3) FIGUEIRA V. (BRA)
4	(*3) FIGUEIRA V. (BRA)	PTS		6	
5	(*24) ASTARITA R. (ITA)	PTS	#43 / 24.01	5	(*24) ASTARITA R. (ITA)
6	(*27) HADDAJI L. (TUN)	PTS		2	
7	(*10) AYOUB ANIS H. (ALG)	PTS	#44 / 24.01	1	(*10) AYOUB ANIS H. (ALG)
8	(*3) FIGUEIRA V. (BRA)	PTS		0	
9	(*10) AYOUB ANIS H. (ALG)	PTS	#47 / 24.01	7	(*10) AYOUB ANIS H. (ALG)
10	(*27) HADDAJI L. (TUN)	PTS		2	
11	(*24) ASTARITA R. (ITA)	PTS	#48 / 24.01	1	(*3) FIGUEIRA V. (BRA)
12	(*3) FIGUEIRA V. (BRA)	PTS		3	

1. FIGUEIRA VINICIUS (BRA)
2. ASTARITA RAFFAELE (ITA)
3. AYOUB ANIS HALASSA (ALG)
4. HADDAJI LAITH (TUN)

1. KOZAKI YUGO (JPN)
2. OZER OMER ABDURRAHIM (TUR)
3. FIGUEIRA VINICIUS (BRA)
3. BALIOTIS GEORGIOS (GRE)
5. DE VIVO GIANLUCA (ITA)
5. RZAZADE NURAN (AZE)
7. YANOVSKYI DAVYD (UKR)
7. MARESCA LUCA (ITA)

*Seeded

Referees:			

Male Kumite -67 Kg - Round Robin (each against each)

Karate1 Premier League - Paris 2025, Pierre de Coubertin Stadium, Avenue George Lafont 82, 75016 Paris, FRA

Tatami

Pool
3/8



1	(*22) O SULLIVAN C. (IRL)	#109 / 24.01	1	(*13) DE VIVO G. (ITA)
2	(*13) DE VIVO G. (ITA)		3	
3	(*18) STEPANOV A. (LAT)	#110 / 24.01	1	(*16) NUNES RIBEIRO D. (POR)
4	(*16) NUNES RIBEIRO D. (POR)		3	
5	(*13) DE VIVO G. (ITA)	#112 / 24.01	5	(*13) DE VIVO G. (ITA)
6	(*18) STEPANOV A. (LAT)		0	
7	(*22) O SULLIVAN C. (IRL)	#113 / 24.01	0	(*16) NUNES RIBEIRO D. (POR)
8	(*16) NUNES RIBEIRO D. (POR)		3	
9	(*22) O SULLIVAN C. (IRL)	#115 / 24.01	2	(*18) STEPANOV A. (LAT)
10	(*18) STEPANOV A. (LAT)		5	
11	(*13) DE VIVO G. (ITA)	#116 / 24.01	0	
12	(*16) NUNES RIBEIRO D. (POR)		0	

1. DE VIVO GIANLUCA (ITA)
2. NUNES RIBEIRO DIOGO MIGUEL (POR)
3. STEPANOV ARTUR (LAT)
4. O SULLIVAN CONOR (IRL)

1. KOZAKI YUGO (JPN)
2. OZER OMER ABDURRAHIM (TUR)
3. FIGUEIRA VINICIUS (BRA)
3. BALIOTIS GEORGIOS (GRE)
5. DE VIVO GIANLUCA (ITA)
5. RZAZADE NURAN (AZE)
7. YANOVSKYI DAVYD (UKR)
7. MARESCA LUCA (ITA)

*Seeded

Referees:			

Male Kumite -67 Kg - Round Robin (each against each)

Karate1 Premier League - Paris 2025, Pierre de Coubertin Stadium, Avenue George Lafont 82, 75016 Paris, FRA

Tatami

Pool
4/8



1	(*9) FREIRE FUENTES T. (CHI)	2	(*9) FREIRE FUENTES T. (CHI)
	#111 / 24.01		
2	(*23) OUALAD HAJ AMAR Y. (BEL)	1	
3	(*9) FREIRE FUENTES T. (CHI)	0	(*2) KOZAKI Y. (JPN)
	#117 / 24.01		
4	(*2) KOZAKI Y. (JPN)	3	
5	(*23) OUALAD HAJ AMAR Y. (BEL)	0	(*2) KOZAKI Y. (JPN)
	#114 / 24.01		
6	(*2) KOZAKI Y. (JPN)	5	

1. KOZAKI YUGO (JPN)
2. FREIRE FUENTES TOMAS (CHI)
3. OUALAD HAJ AMAR YOUNESS (BEL)

1. KOZAKI YUGO (JPN)
2. OZER OMER ABDURRAHIM (TUR)
3. FIGUEIRA VINICIUS (BRA)
3. BALIOTIS GEORGIOS (GRE)
5. DE VIVO GIANLUCA (ITA)
5. RZAZADE NURAN (AZE)
7. YANOVSKYI DAVYD (UKR)
7. MARESCA LUCA (ITA)

*Seeded

Referees:			

Male Kumite -67 Kg - Round Robin (each against each)

Karate1 Premier League - Paris 2025, Pierre de Coubertin Stadium, Avenue George Lafont 82, 75016 Paris, FRA

Tatami

Pool
5/8



1	(*12) SHIH C. (TPE)	#178 / 24.01	1	(*14) RZAZADE N. (AZE)
2	(*14) RZAZADE N. (AZE)	5		
3	(*30) BORZOOEICHAGHAGOLANI A. (IRI)	#179 / 24.01	6	(*30) BORZOOEICHAGHAGOLANI A. (IRI)
4	(*5) GHAITH A. (JOR)	4		
5	(*14) RZAZADE N. (AZE)	#182 / 24.01	5	(*14) RZAZADE N. (AZE)
6	(*30) BORZOOEICHAGHAGOLANI A. (IRI)	0		
7	(*12) SHIH C. (TPE)	#183 / 24.01	7	(*12) SHIH C. (TPE)
8	(*5) GHAITH A. (JOR)	1		
9	(*12) SHIH C. (TPE)	#186 / 24.01	5	(*12) SHIH C. (TPE)
10	(*30) BORZOOEICHAGHAGOLANI A. (IRI)	3		
11	(*14) RZAZADE N. (AZE)	#187 / 24.01	7	(*14) RZAZADE N. (AZE)
12	(*5) GHAITH A. (JOR)	3		

1. RZAZADE NURAN (AZE)
2. SHIH CHENG-CHUNG (TPE)
3. BORZOOEICHAGHAGOLANI AMIRREZA (IRI)
4. GHAITH AFEEF (JOR)

1. KOZAKI YUGO (JPN)
2. OZER OMER ABDURRAHIM (TUR)
3. FIGUEIRA VINICIUS (BRA)
3. BALIOTIS GEORGIOS (GRE)
5. DE VIVO GIANLUCA (ITA)
5. RZAZADE NURAN (AZE)
7. YANOVSKYI DAVYD (UKR)
7. MARESCA LUCA (ITA)

*Seeded

Referees:			

Male Kumite -67 Kg - Round Robin (each against each)

Karate1 Premier League - Paris 2025, Pierre de Coubertin Stadium, Avenue George Lafont 82, 75016 Paris, FRA

Tatami

Pool
6/8



1. MARESCA LUCA (ITA)
2. OEZDEMIR MUHAMMED (GER)
3. HOMOLA MATEJ (SVK)
4. TAS YANIS (FRA)

1. KOZAKI YUGO (JPN)
2. OZER OMER ABDURRAHIM (TUR)
3. FIGUEIRA VINICIUS (BRA)
3. BALIOTIS GEORGIOS (GRE)
5. DE VIVO GIANLUCA (ITA)
5. RZAZADE NURAN (AZE)
7. YANOVSKYI DAVYD (UKR)
7. MARESCA LUCA (ITA)

*Seeded

Referees:			

Male Kumite -67 Kg - Round Robin (each against each)

Karate1 Premier League - Paris 2025, Pierre de Coubertin Stadium, Avenue George Lafont 82, 75016 Paris, FRA

Tatami

Pool
7/8

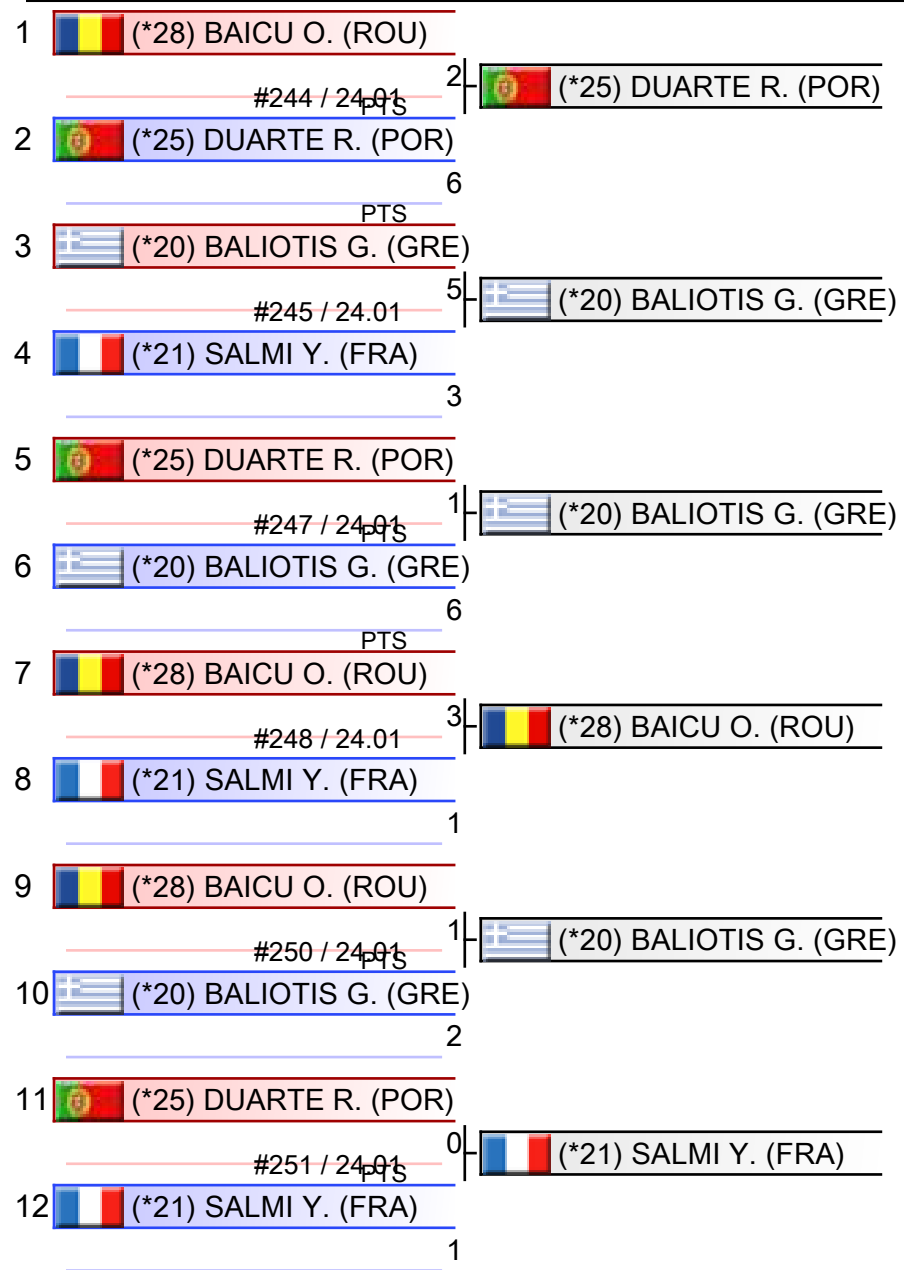

1. BALIOTIS GEORGIOS (GRE)
2. DUARTE RAFAEL (POR)
3. BAICU ORLANDO (ROU)
4. SALMI YOUNESSE (FRA)

1. KOZAKI YUGO (JPN)
2. OZER OMER ABDURRAHIM (TUR)
3. FIGUEIRA VINICIUS (BRA)
3. BALIOTIS GEORGIOS (GRE)
5. DE VIVO GIANLUCA (ITA)
5. RZAZADE NURAN (AZE)
7. YANOVSKYI DAVYD (UKR)
7. MARESCA LUCA (ITA)

*Seeded

Referees:			

Male Kumite -67 Kg - Round Robin (each against each)

Karate1 Premier League - Paris 2025, Pierre de Coubertin Stadium, Avenue George Lafont 82, 75016 Paris, FRA

Tatami

Pool
8/8



1	(*29) WILSON J. (ENG)	#246 / 24.01	1	(*6) OZER O. (TUR)
2	(*6) OZER O. (TUR)		3	
3	(*29) WILSON J. (ENG)	#252 / 24.01	3	(*1) OUBAYA S. (MAR)
4	(*1) OUBAYA S. (MAR)		4	
5	(*6) OZER O. (TUR)	PTS	1	(*6) OZER O. (TUR)
6	(*1) OUBAYA S. (MAR)	#249 / 24.01	0	

1. OZER OMER ABDURRAHIM (TUR)
2. OUBAYA SAID (MAR)
3. WILSON JOBY (ENG)

1. KOZAKI YUGO (JPN)
2. OZER OMER ABDURRAHIM (TUR)
3. FIGUEIRA VINICIUS (BRA)
3. BALIOTIS GEORGIOS (GRE)
5. DE VIVO GIANLUCA (ITA)
5. RZAZADE NURAN (AZE)
7. YANOVSKYI DAVYD (UKR)
7. MARESCA LUCA (ITA)

*Seeded

Referees:			

Pool winner-Male Kumite -67 Kg

Karate1 Premier League - Paris 2025, Pierre de Coubertin Stadium, Avenue George Lafont 82, 75016 Paris, FRA

Tatami

Pool
1/1

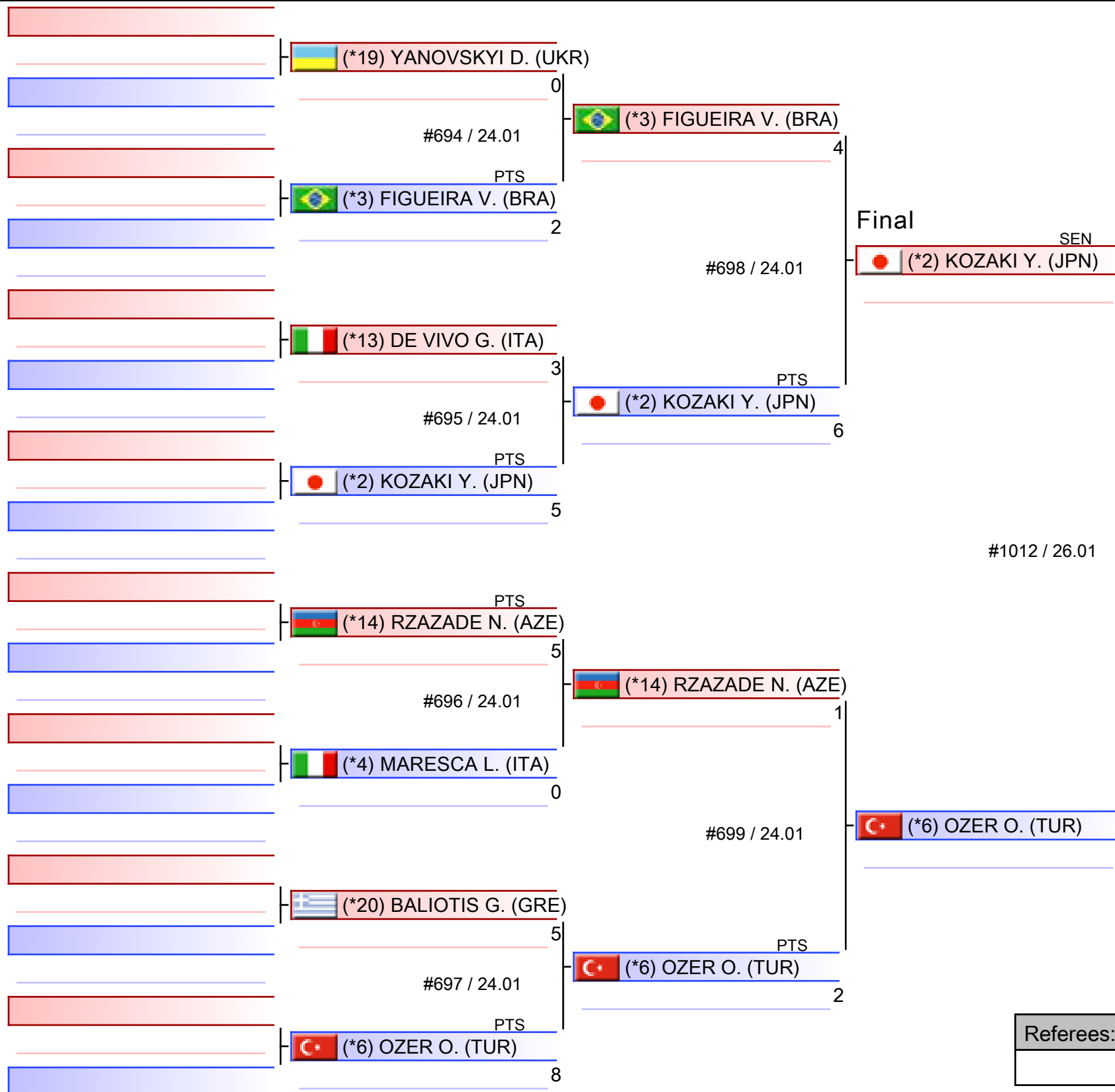

1. KOZAKI YUGO (JPN)
2. OZER OMER ABDURRAHIM (TUR)
3. FIGUEIRA VINICIUS (BRA)
3. BALIOTIS GEORGIOS (GRE)
5. DE VIVO GIANLUCA (ITA)
5. RZAZADE NURAN (AZE)
7. YANOVSKYI DAVYD (UKR)
7. MARESCA LUCA (ITA)

*Seeded

Referees:			

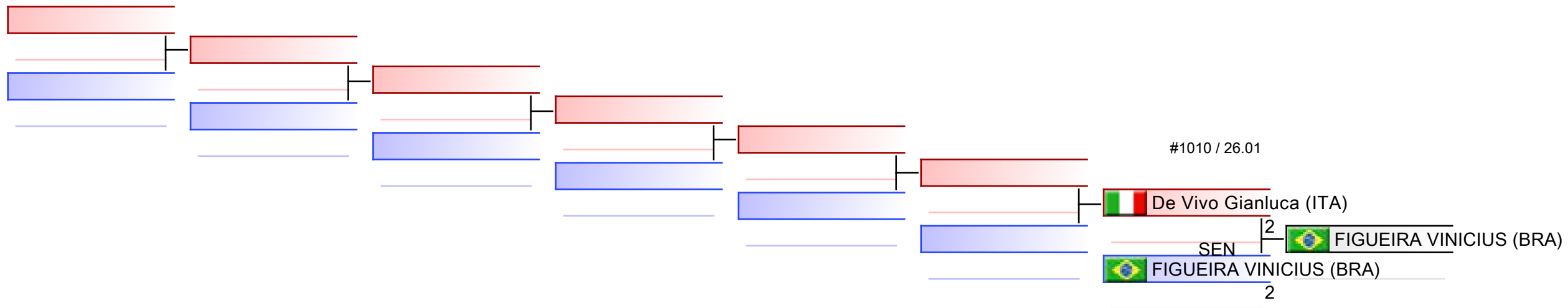

REPECHAGE: (1,2,3,4,5,6,7,8)

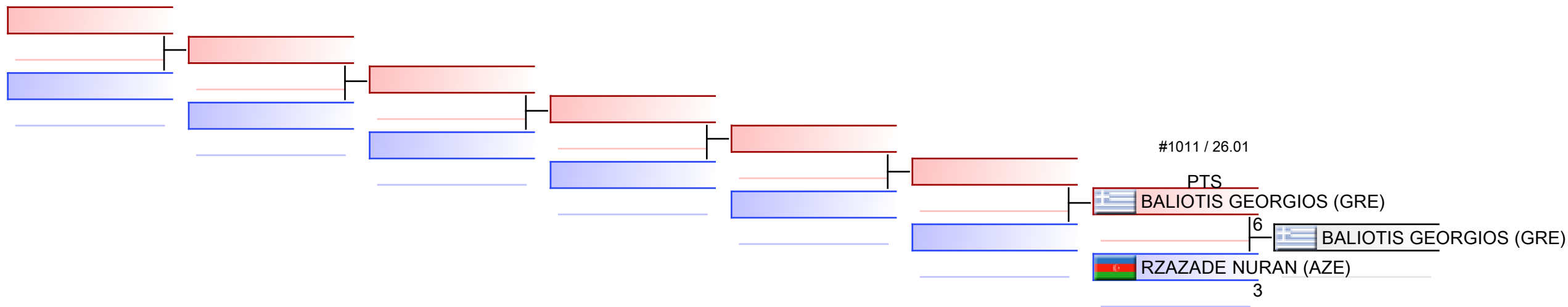

Referees:							
-----------	--	--	--	--	--	--	--

MALE KUMITE -75 KG



Karate1 Premier League - Paris 2025

ENTRIES BY WEIGHT CATEGORY



Male Kumite -75 Kg

As of 27 JAN 2025

Country Code	ID	Gender	Name	Seeding
ALG	ALG04187	M	Zaid Oussama	18
BEL	BEL2033	M	MAHAUDEN QUENTIN	7
CHI	CHI128	M	GONZALEZ LAVIN JOAQUIN	30
EGY	EGY2218	M	Abdelaziz Abdalla	1
EGY	EGY2524	M	Abdelgawad Abdalla Hesham	13
FRA	FRA02858	M	Assemat Hugo	31
FRA	FRA2231	M	BERTHON ENZO	3
FRA	FRA2234	M	CIZO KILIAN	25
FRA	FRA2195	M	LE THANH LIEM	23
GEO	GEO02275	M	PONIAVA VALIKO	20
GUA	GUA2037	M	MALDONADO ALLAN	19
IRI	IRI187	M	ASGARI GHONCHEH BAHMAN	10
ITA	ITA2510	M	De Vivo Daniele	11
ITA	ITA552	M	Pietromarchi Lorenzo	15
ITA	ITA2746	M	Rossi Joseph	24
JOR	JOR2164	M	MASARWEH HASAN	14
JPN	JPN2313	M	Sakiyama Yusei	9
JPN	JPN2661	M	Suzuki Shunji	26
KAZ	KAZ2028	M	AZHIKANOV NURKANAT	2
KUW	KUW2002	M	ALJENAEI OMAR	21
LBA	LBA02377	M	ABUDABOUS MOHAMED	12
MNE	MNE2045	M	MIKULIC NEMANJA	17
NED	NED02684	M	FRANKEN RICARDO	16
NED	NED2342	M	Teeffelen van Sebastiaan	27
POR	POR2177	M	Duarte Tiago	22
TKM	TKM02089	M	NAZMYRADOV DAVUT	29
TUR	TUR644	M	BULUT ENES	5
TUR	TUR2674	M	YURUR OMER FARUK	4
UKR	UKR02683	M	Pitsul Heorhii	8
UKR	UKR02715	M	RAHOZENKO ERIK	28
UKR	UKR2204	M	ZAPLITNYI ANDRII	6

Male Kumite -75 Kg - Round Robin (each against each)

Karate1 Premier League - Paris 2025, Pierre de Coubertin Stadium, Avenue George Lafont 82, 75016 Paris, FRA

Tatami

Pool
1/8



1. ABUDABOUS MOHAMED (LBA)
2. DUARTE TIAGO (POR)
3. PIETROMARCHI LORENZO (ITA)
4. ASSEMAT HUGO (FRA)

1. ABDELAZIZ ABDALLA (EGY)
2. MIKULIC NEMANJA (MNE)
3. RAHOZENKO ERIK (UKR)
3. ABDELGAWAD ABDALLA HESHAM (EGY)
5. ABUDABOUS MOHAMED (LBA)
5. PITSUL HEORHII (UKR)
7. BERTHON ENZO (FRA)
7. SAKIYAMA YUSEI (JPN)

*Seeded

Referees:			

Male Kumite -75 Kg - Round Robin (each against each)

Karate1 Premier League - Paris 2025, Pierre de Coubertin Stadium, Avenue George Lafont 82, 75016 Paris, FRA

Tatami

Pool
2/8



1	(*10) ASGARI GHONCHEH B. (IRI)	5	(*10) ASGARI GHONCHEH B. (IRI)
	#63 / 24.01		
2	(*19) MALDONADO A. (GUA)	1	
3	(*7) MAHAUDEN Q. (BEL)	1	(*3) BERTHON E. (FRA)
	#64 / 24.01		
4	(*3) BERTHON E. (FRA)	6	
5	(*19) MALDONADO A. (GUA)	0	(*7) MAHAUDEN Q. (BEL)
	#67 / 24.01		
6	(*7) MAHAUDEN Q. (BEL)	5	
7	(*10) ASGARI GHONCHEH B. (IRI)	2	(*3) BERTHON E. (FRA)
	#68 / 24.01		
8	(*3) BERTHON E. (FRA)	3	
9	(*10) ASGARI GHONCHEH B. (IRI)	3	(*7) MAHAUDEN Q. (BEL)
	#71 / 24.01		
10	(*7) MAHAUDEN Q. (BEL)	3	
11	(*19) MALDONADO A. (GUA)	0	
	#72 / 24.01		
12	(*3) BERTHON E. (FRA)	0	

1. BERTHON ENZO (FRA)
2. MAHAUDEN QUENTIN (BEL)
3. ASGARI GHONCHEH BAHMAN (IRI)
4. MALDONADO ALLAN (GUA)

1. ABDELAZIZ ABDALLA (EGY)
2. MIKULIC NEMANJA (MNE)
3. RAHOZENKO ERIK (UKR)
3. ABDELGAWAD ABDALLA HESHAM (EGY)
5. ABUDABOUS MOHAMED (LBA)
5. PITSUL HEORHII (UKR)
7. BERTHON ENZO (FRA)
7. SAKIYAMA YUSEI (JPN)

*Seeded

Referees:			

Male Kumite -75 Kg - Round Robin (each against each)

Karate1 Premier League - Paris 2025, Pierre de Coubertin Stadium, Avenue George Lafont 82, 75016 Paris, FRA

Tatami

Pool
3/8



1	(*5) BULUT E. (TUR)	0	(*17) MIKULIC N. (MNE)
	#130 / 24.01		
2	(*17) MIKULIC N. (MNE)	4	
3	(*25) CIZO K. (FRA)	0	(*18) ZAID O. (ALG)
	#131 / 24.01		
4	(*18) ZAID O. (ALG)	4	
	PTS		
5	(*17) MIKULIC N. (MNE)	7	(*17) MIKULIC N. (MNE)
	#134 / 24.01		
6	(*25) CIZO K. (FRA)	2	
7	(*5) BULUT E. (TUR)	1	(*18) ZAID O. (ALG)
	#135 / 24.01		
8	(*18) ZAID O. (ALG)	2	
9	(*5) BULUT E. (TUR)	0	(*25) CIZO K. (FRA)
	#138 / 24.01		
10	(*25) CIZO K. (FRA)	1	
	PTS		
11	(*17) MIKULIC N. (MNE)	4	(*17) MIKULIC N. (MNE)
	#139 / 24.01		
12	(*18) ZAID O. (ALG)	3	

1. MIKULIC NEMANJA (MNE)
2. ZAID OUSSAMA (ALG)
3. CIZO KILIAN (FRA)
4. BULUT ENES (TUR)

1. ABDELAZIZ ABDALLA (EGY)
2. MIKULIC NEMANJA (MNE)
3. RAHOZENKO ERIK (UKR)
3. ABDELGAWAD ABDALLA HESHAM (EGY)
5. ABUDABOUS MOHAMED (LBA)
5. PITSUL HEORHII (UKR)
7. BERTHON ENZO (FRA)
7. SAKIYAMA YUSEI (JPN)

*Seeded

Referees:			

Male Kumite -75 Kg - Round Robin (each against each)

Karate1 Premier League - Paris 2025, Pierre de Coubertin Stadium, Avenue George Lafont 82, 75016 Paris, FRA

Tatami

Pool
4/8

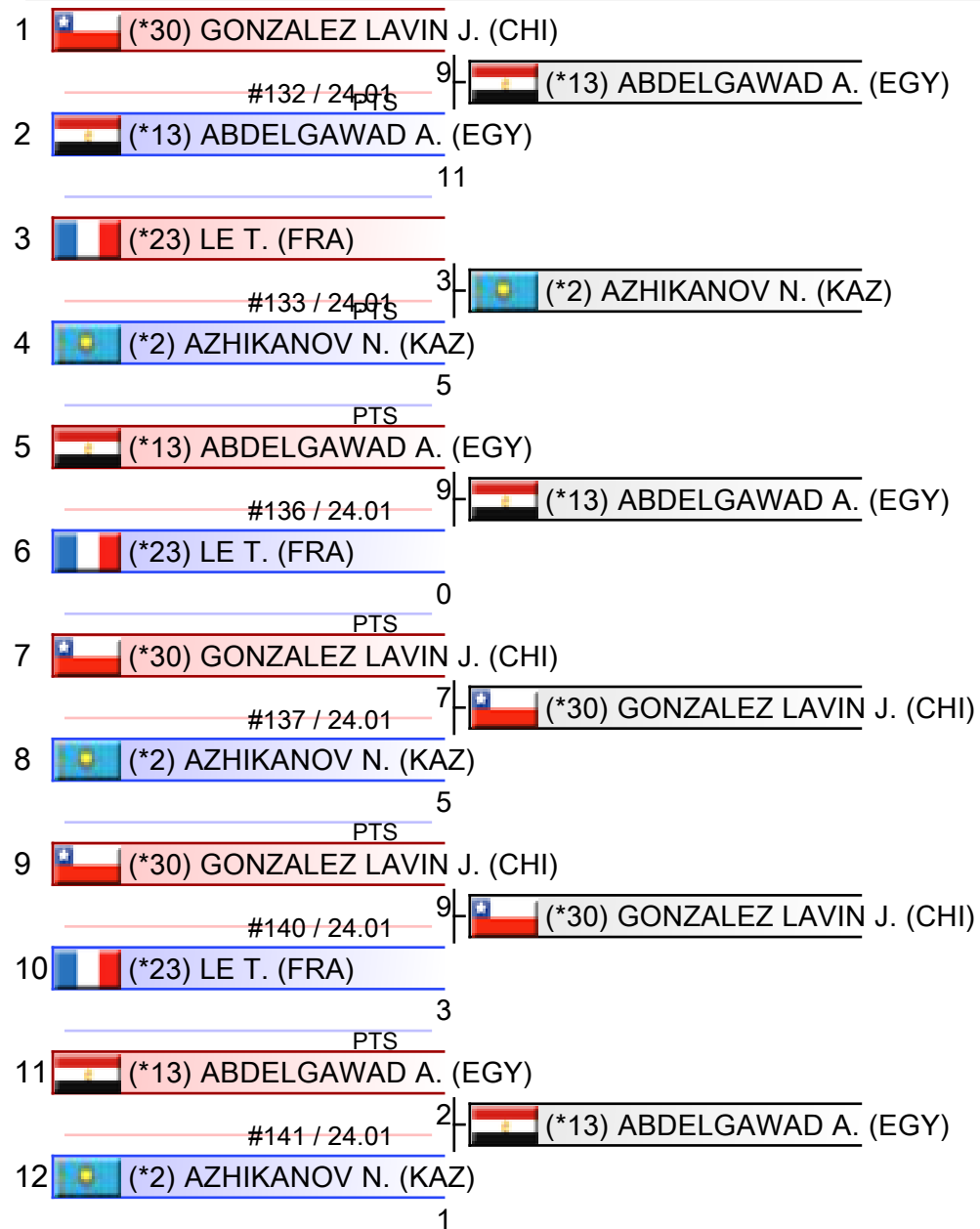

1. ABDELGAWAD ABDALLA HESHAM (EGY)
2. GONZALEZ LAVIN JOAQUIN (CHI)
3. AZHIKANOV NURKANAT (KAZ)
4. LE THANH LIEM (FRA)

1. ABDELAZIZ ABDALLA (EGY)
2. MIKULIC NEMANJA (MNE)
3. RAHOZENKO ERIK (UKR)
3. ABDELGAWAD ABDALLA HESHAM (EGY)
5. ABUDABOUS MOHAMED (LBA)
5. PITSUL HEORHII (UKR)
7. BERTHON ENZO (FRA)
7. SAKIYAMA YUSEI (JPN)

*Seeded

Referees:			

Male Kumite -75 Kg - Round Robin (each against each)

Karate1 Premier League - Paris 2025, Pierre de Coubertin Stadium, Avenue George Lafont 82, 75016 Paris, FRA

Tatami

Pool
5/8



1. SAKIYAMA YUSEI (JPN)
2. DE VIVO DANIELE (ITA)
3. TEEFFELEN VAN SEBASTIAAN (NED)
4. NAZMYRADOV DAVUT (TKM)

1. ABDELAZIZ ABDALLA (EGY)
2. MIKULIC NEMANJA (MNE)
3. RAHOZENKO ERIK (UKR)
3. ABDELGAWAD ABDALLA HESHAM (EGY)
5. ABUDABOUS MOHAMED (LBA)
5. PITSUL HEORHII (UKR)
7. BERTHON ENZO (FRA)
7. SAKIYAMA YUSEI (JPN)

*Seeded

Referees:			

Male Kumite -75 Kg - Round Robin (each against each)

Karate1 Premier League - Paris 2025, Pierre de Coubertin Stadium, Avenue George Lafont 82, 75016 Paris, FRA

Tatami

Pool
6/8



1	(*8) PITSUL H. (UKR)	4	(*8) PITSUL H. (UKR)
	#204 / 24.01		
2	(*14) MASARWEH H. (JOR)	2	
3	(*20) PONIAVA V. (GEO)	0	
	#205 / 24.01		
4	(*4) YURUR O. (TUR)	0	
	PTS		
5	(*14) MASARWEH H. (JOR)	2	(*14) MASARWEH H. (JOR)
	#208 / 24.01		
6	(*20) PONIAVA V. (GEO)	0	
	PTS		
7	(*8) PITSUL H. (UKR)	3	(*8) PITSUL H. (UKR)
	#209 / 24.01		
8	(*4) YURUR O. (TUR)	1	
	PTS		
9	(*8) PITSUL H. (UKR)	2	(*8) PITSUL H. (UKR)
	#212 / 24.01		
10	(*20) PONIAVA V. (GEO)	0	
	KI		
11	(*14) MASARWEH H. (JOR)	4	(*14) MASARWEH H. (JOR)
	#213 / 24.01		
12	(*4) YURUR O. (TUR)	0	

1. PITSUL HEORHII (UKR)
2. MASARWEH HASAN (JOR)
3. YURUR OMER FARUK (TUR)
4. PONIAVA VALIKO (GEO)

1. ABDELAZIZ ABDALLA (EGY)
2. MIKULIC NEMANJA (MNE)
3. RAHOZENKO ERIK (UKR)
3. ABDELGAWAD ABDALLA HESHAM (EGY)
5. ABUDABOUS MOHAMED (LBA)
5. PITSUL HEORHII (UKR)
7. BERTHON ENZO (FRA)
7. SAKIYAMA YUSEI (JPN)

*Seeded

Referees:			

Male Kumite -75 Kg - Round Robin (each against each)

Karate1 Premier League - Paris 2025, Pierre de Coubertin Stadium, Avenue George Lafont 82, 75016 Paris, FRA

Tatami

Pool
7/8

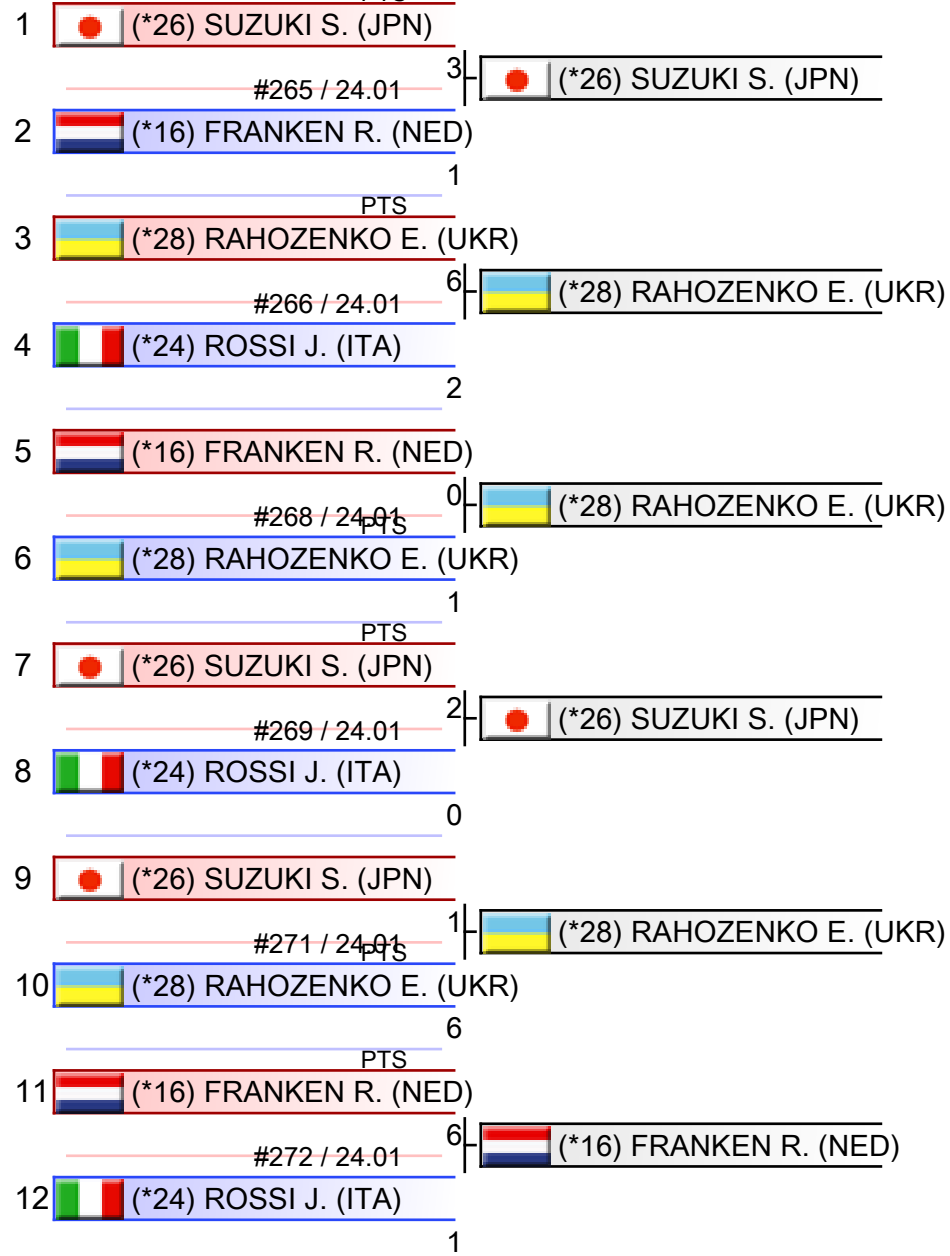

1. RAHOZENKO ERIK (UKR)
2. SUZUKI SHUNJI (JPN)
3. FRANKEN RICARDO (NED)
4. ROSSI JOSEPH (ITA)

1. ABDELAZIZ ABDALLA (EGY)
2. MIKULIC NEMANJA (MNE)
3. RAHOZENKO ERIK (UKR)
3. ABDELGAWAD ABDALLA HESHAM (EGY)
5. ABUDABOUS MOHAMED (LBA)
5. PITSUL HEORHII (UKR)
7. BERTHON ENZO (FRA)
7. SAKIYAMA YUSEI (JPN)

*Seeded

Referees:			

Male Kumite -75 Kg - Round Robin (each against each)

Karate1 Premier League - Paris 2025, Pierre de Coubertin Stadium, Avenue George Lafont 82, 75016 Paris, FRA

Tatami

Pool
8/8



1	(*6) ZAPLITNYI A. (UKR)	#267 / 24-015	3	(*21) ALJENAEI O. (KUW)
2	(*21) ALJENAEI O. (KUW)		4	
3	(*6) ZAPLITNYI A. (UKR)	#273 / 24-015	2	(*1) ABDELAZIZ A. (EGY)
4	(*1) ABDELAZIZ A. (EGY)		5	
5	(*21) ALJENAEI O. (KUW)	#270 / 24-015	0	(*1) ABDELAZIZ A. (EGY)
6	(*1) ABDELAZIZ A. (EGY)		5	

1. ABDELAZIZ ABDALLA (EGY)
2. ALJENAEI OMAR (KUW)
3. ZAPLITNYI ANDRII (UKR)

1. ABDELAZIZ ABDALLA (EGY)
2. MIKULIC NEMANJA (MNE)
3. RAHOZENKO ERIK (UKR)
3. ABDELGAWAD ABDALLA HESHAM (EGY)
5. ABUDABOUS MOHAMED (LBA)
5. PITSUL HEORHII (UKR)
7. BERTHON ENZO (FRA)
7. SAKIYAMA YUSEI (JPN)

*Seeded

Referees:			

Pool winner-Male Kumite -75 Kg

Karate1 Premier League - Paris 2025, Pierre de Coubertin Stadium, Avenue George Lafont 82, 75016 Paris, FRA

Tatami

Pool
1/1

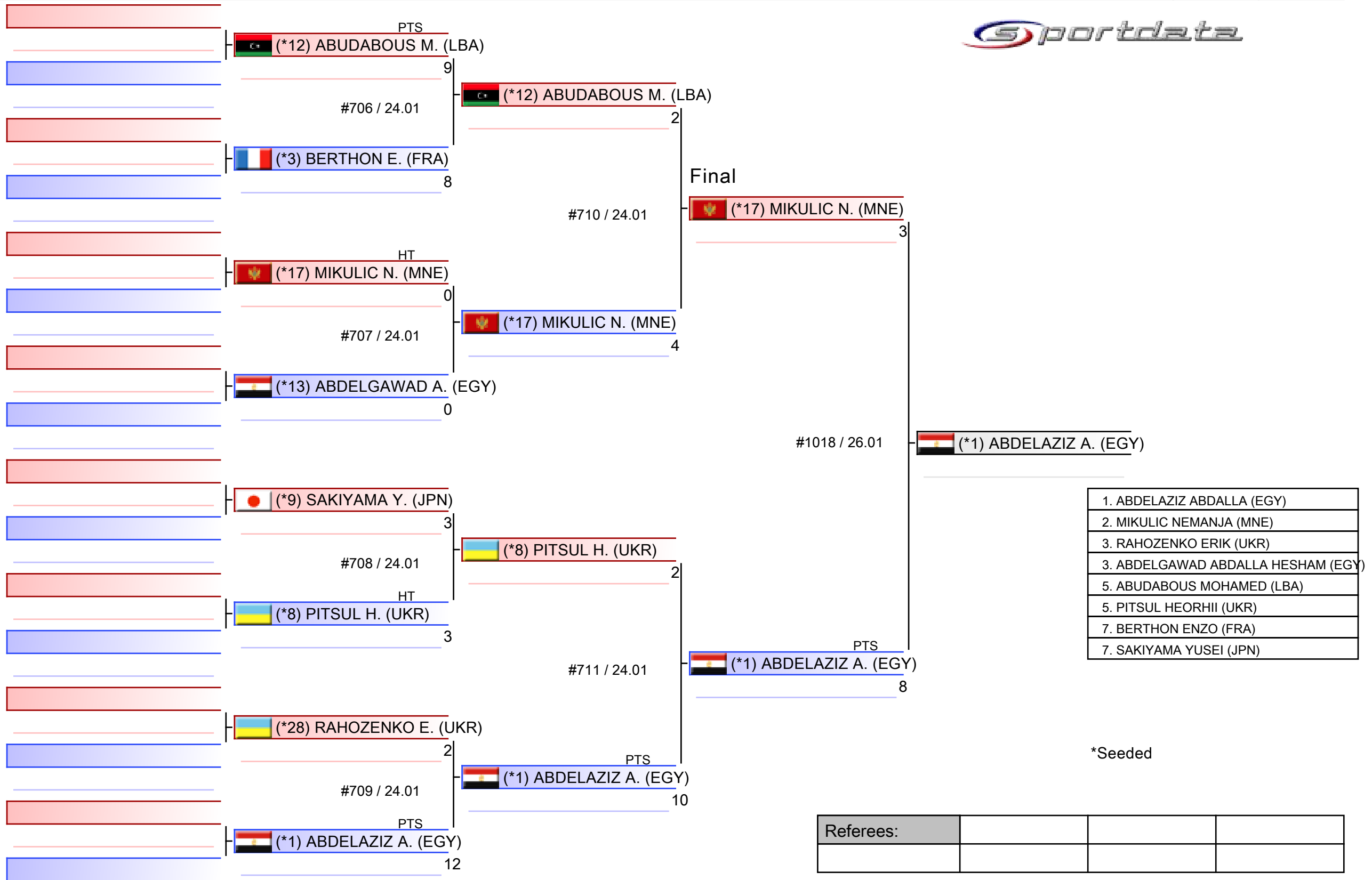

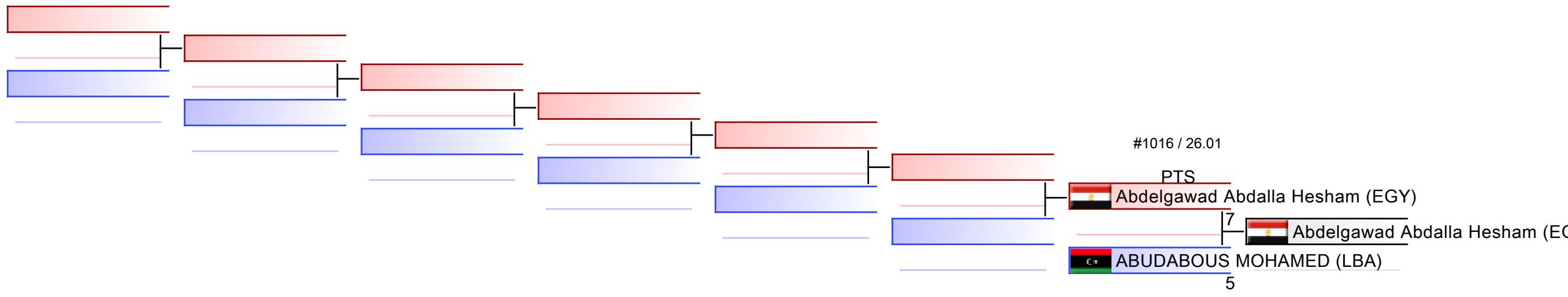

REPECHAGE: (1,2,3,4,5,6,7,8)

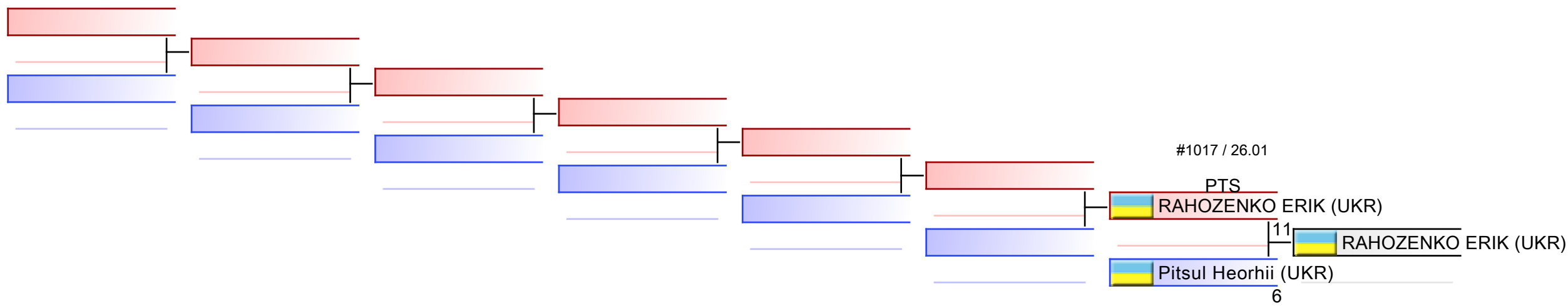

Referees:							
-----------	--	--	--	--	--	--	--

MALE KUMITE -84 KG



Karate1 Premier League - Paris 2025

ENTRIES BY WEIGHT CATEGORY



Male Kumite -84 Kg

As of 27 JAN 2025

Country Code	ID	Gender	Name	Seeding
ALB	ALB02650	M	GASHI MELOS	16
ALG	ALG04850	M	MIDOUNE FALLEH	15
AZE	AZE211	M	HASANOV TURGUT	21
BEL	BEL2005	M	DEGHALI WALID	14
CRO	CRO399	M	KVESIC IVAN	6
ECU	ECU02313	M	Acevedo Jose	19
EGY	EGY2625	M	Badawy Youssef	2
FIN	FIN2013	M	Kulovuori Bjorn	32
FIN	FIN2061	M	Mantere Niko	31
GEO	GEO2152	M	VASADZE LUKA	13
GER	GER2481	M	HAUBOLD JANNE	28
GRE	GRE487	M	MASTROGIANNIS KONSTANTINOS	3
IRI	IRI2164	M	KHODABAKHSHI MAHDI	17
ITA	ITA2508	M	Fiore Matteo	10
ITA	ITA494	M	Martina Michele	11
JOR	JOR2281	M	ALJAFARI MOHAMMAD	1
JPN	JPN2396	M	ETO JUNYA	18
JPN	JPN2314	M	Shimada Rikito	5
KAZ	KAZ212	M	YULDASHEV DANIYAR	9
LAT	SD24496	M	SADIKOV DENS	26
MAR	MAR2275	M	SRITI MEHDI	12
MKD	MKD285	M	Spasenovski Petar	27
MNE	MNE246	M	MALOVIC NIKOLA	22
NED	NED2028	M	Timmermans Brian	8
POL	POL2671	M	FLORCZAK MICHAL	29
SEN	SEN02471	M	DIOP MAKHTAR	25
SVK	SVK327	M	Smoliga Julian Enrik	30
TUR	TUR2211	M	ARSLAN HASAN	7
TUR	TUR03291	M	TEMIZEL YUSUF EREN	23
UKR	UKR274	M	CHOBOTAR VALERII	4
UKR	UKR2087	M	SONNYKH VALERII	24
UKR	UKR2021	M	TOROSHANKO ANDRII	20

Male Kumite -84 Kg - Round Robin (each against each)

Karate1 Premier League - Paris 2025, Pierre de Coubertin Stadium, Avenue George Lafont 82, 75016 Paris, FRA

Tatami

Pool
1/8



1	(*28) HAUBOLD J. (GER)	#424 / 25.01	3	(*18) ETO J. (JPN)
2	(*18) ETO J. (JPN)		5	
3	(*27) SPASENOVSKI P. (MKD)	#425 / 25.01	2	
4	(*20) TOROSHANKO A. (UKR)		2	
5	(*18) ETO J. (JPN)	#428 / 25.01	4	(*18) ETO J. (JPN)
6	(*27) SPASENOVSKI P. (MKD)		3	
7	(*28) HAUBOLD J. (GER)	#429 / 25.01	4	(*28) HAUBOLD J. (GER)
8	(*20) TOROSHANKO A. (UKR)		0	
9	(*28) HAUBOLD J. (GER)	#432 / 25.01	1	(*27) SPASENOVSKI P. (MKD)
10	(*27) SPASENOVSKI P. (MKD)		3	
11	(*18) ETO J. (JPN)	#433 / 25.01	4	(*18) ETO J. (JPN)
12	(*20) TOROSHANKO A. (UKR)		0	

1. ETO JUNYA (JPN)
2. SPASENOVSKI PETAR (MKD)
3. HAUBOLD JANNE (GER)
4. TOROSHANKO ANDRII (UKR)

1. BADAWY YOUSSEF (EGY)
2. ALJAFARI MOHAMMAD (JOR)
3. ETO JUNYA (JPN)
3. SRITI MEHDI (MAR)
5. MARTINA MICHELE (ITA)
5. FIORE MATTEO (ITA)
7. ACEVEDO JOSE (ECU)
7. DIOP MAKHTAR (SEN)

*Seeded

Referees:			

Male Kumite -84 Kg - Round Robin (each against each)

Karate1 Premier League - Paris 2025, Pierre de Coubertin Stadium, Avenue George Lafont 82, 75016 Paris, FRA

Tatami

Pool
2/8



1	(*5) SHIMADA R. (JPN)	#426 / 25.01	1	(*19) ACEVEDO J. (ECU)
2	(*19) ACEVEDO J. (ECU)		3	
3	(*6) KVESIC I. (CRO)	#427 / 25.01	4	(*3) MASTROGIANNIS K. (GRE)
4	(*3) MASTROGIANNIS K. (GRE)		4	
5	(*19) ACEVEDO J. (ECU)		4	(*19) ACEVEDO J. (ECU)
6	(*6) KVESIC I. (CRO)		3	
7	(*5) SHIMADA R. (JPN)	#431 / 25.01	4	(*5) SHIMADA R. (JPN)
8	(*3) MASTROGIANNIS K. (GRE)		1	
9	(*5) SHIMADA R. (JPN)	#434 / 25.01	8	(*5) SHIMADA R. (JPN)
10	(*6) KVESIC I. (CRO)		0	
11	(*19) ACEVEDO J. (ECU)	#435 / 25.01	1	(*19) ACEVEDO J. (ECU)
12	(*3) MASTROGIANNIS K. (GRE)		4	

1. ACEVEDO JOSE (ECU)
2. SHIMADA RIKITO (JPN)
3. MASTROGIANNIS KONSTANTINOS (GRE)
4. KVESIC IVAN (CRO)

1. BADAWY YOUSSEF (EGY)
2. ALJAFARI MOHAMMAD (JOR)
3. ETO JUNYA (JPN)
3. SRITI MEHDI (MAR)
5. MARTINA MICHELE (ITA)
5. FIORE MATTEO (ITA)
7. ACEVEDO JOSE (ECU)
7. DIOP MAKHTAR (SEN)

*Seeded

Referees:			

Male Kumite -84 Kg - Round Robin (each against each)

Karate1 Premier League - Paris 2025, Pierre de Coubertin Stadium, Avenue George Lafont 82, 75016 Paris, FRA

Tatami

Pool
3/8



1. MARTINA MICHELE (ITA)
2. SONNYKH VALERII (UKR)
3. MANTERE NIKO (FIN)
4. SMOLIGA JULIAN ENRIK (SVK)

1. BADAWY YOUSSEF (EGY)
2. ALJAFARI MOHAMMAD (JOR)
3. ETO JUNYA (JPN)
3. SRITI MEHDI (MAR)
5. MARTINA MICHELE (ITA)
5. FIORE MATTEO (ITA)
7. ACEVEDO JOSE (ECU)
7. DIOP MAKHTAR (SEN)

*Seeded

Referees:			

Male Kumite -84 Kg - Round Robin (each against each)

Karate1 Premier League - Paris 2025, Pierre de Coubertin Stadium, Avenue George Lafont 82, 75016 Paris, FRA

Tatami

Pool
4/8



1	(*7) ARSLAN H. (TUR)		
	#498 / 25.01	9	(*7) ARSLAN H. (TUR)
2	(*15) MIDOUNE F. (ALG)		
		1	
3	(*17) KHODABAKHSHI M. (IRI)		
	#499 / 25.01	4	(*2) BADAWEY Y. (EGY)
4	(*2) BADAWEY Y. (EGY)		
		7	
5	(*15) MIDOUNE F. (ALG)		
	#502 / 25.01	0	(*17) KHODABAKHSHI M. (IRI)
6	(*17) KHODABAKHSHI M. (IRI)		
		4	
7	(*7) ARSLAN H. (TUR)		
	#503 / 25.01	0	(*2) BADAWEY Y. (EGY)
8	(*2) BADAWEY Y. (EGY)		
		2	
	PTS		
9	(*7) ARSLAN H. (TUR)		
	#506 / 25.01	2	(*7) ARSLAN H. (TUR)
10	(*17) KHODABAKHSHI M. (IRI)		
		1	
11	(*15) MIDOUNE F. (ALG)		
	#507 / 25.01	0	(*2) BADAWEY Y. (EGY)
12	(*2) BADAWEY Y. (EGY)		
		8	

1. BADAWEY YOUSSEF (EGY)
2. ARSLAN HASAN (TUR)
3. KHODABAKHSHI MAHDI (IRI)
4. MIDOUNE FALLEH (ALG)

1. BADAWEY YOUSSEF (EGY)
2. ALJAFARI MOHAMMAD (JOR)
3. ETO JUNYA (JPN)
3. SRITI MEHDI (MAR)
5. MARTINA MICHELE (ITA)
5. FIORE MATTEO (ITA)
7. ACEVEDO JOSE (ECU)
7. DIOP MAKHTAR (SEN)

*Seeded

Referees:			

Male Kumite -84 Kg - Round Robin (each against each)

Karate1 Premier League - Paris 2025, Pierre de Coubertin Stadium, Avenue George Lafont 82, 75016 Paris, FRA

Tatami

Pool
5/8



1. FIORE MATTEO (ITA)
2. YULDASHEV DANIYAR (KAZ)
3. FLORCZAK MICHAL (POL)
4. DEGHALI WALID (BEL)

1. BADAWY YOUSSEF (EGY)
2. ALJAFARI MOHAMMAD (JOR)
3. ETO JUNYA (JPN)
3. SRITI MEHDI (MAR)
5. MARTINA MICHELE (ITA)
5. FIORE MATTEO (ITA)
7. ACEVEDO JOSE (ECU)
7. DIOP MAKHTAR (SEN)

*Seeded

Referees:			

Male Kumite -84 Kg - Round Robin (each against each)

Karate1 Premier League - Paris 2025, Pierre de Coubertin Stadium, Avenue George Lafont 82, 75016 Paris, FRA

Tatami

Pool
6/8



1. DIOP MAKHTAR (SEN)
2. CHOBOTAR VALERII (UKR)
3. TEMIZEL YUSUF EREN (TUR)
4. GASHI MELOS (ALB)

1. BADAWY YOUSSEF (EGY)
2. ALJAFARI MOHAMMAD (JOR)
3. ETO JUNYA (JPN)
3. SRITI MEHDI (MAR)
5. MARTINA MICHELE (ITA)
5. FIORE MATTEO (ITA)
7. ACEVEDO JOSE (ECU)
7. DIOP MAKHTAR (SEN)

*Seeded

Referees:			

Male Kumite -84 Kg - Round Robin (each against each)

Karate1 Premier League - Paris 2025, Pierre de Coubertin Stadium, Avenue George Lafont 82, 75016 Paris, FRA

Tatami

Pool
7/8



1	(*12) SRITI M. (MAR)	5	(*12) SRITI M. (MAR)
	#634 / 25.01		
2	(*21) HASANOV T. (AZE)	0	
3	(*26) SADIKOV S D. (LAT)	1	(*22) MALOVIC N. (MNE)
	#635 / 25.01		
4	(*22) MALOVIC N. (MNE)	7	
	PTS		
5	(*21) HASANOV T. (AZE)	2	(*21) HASANOV T. (AZE)
	#638 / 25.01		
6	(*26) SADIKOV S D. (LAT)	1	
	PTS		
7	(*12) SRITI M. (MAR)	4	(*12) SRITI M. (MAR)
	#639 / 25.01		
8	(*22) MALOVIC N. (MNE)	2	
	PTS		
9	(*12) SRITI M. (MAR)	10	(*12) SRITI M. (MAR)
	#642 / 25.01		
10	(*26) SADIKOV S D. (LAT)	1	
	PTS		
11	(*21) HASANOV T. (AZE)	4	(*22) MALOVIC N. (MNE)
	#643 / 25.01		
12	(*22) MALOVIC N. (MNE)	4	
	PTS		

1. SRITI MEHDI (MAR)
2. MALOVIC NIKOLA (MNE)
3. HASANOV TURGUT (AZE)
4. SADIKOV S DENS (LAT)

1. BADAWY YOUSSEF (EGY)
2. ALJAFARI MOHAMMAD (JOR)
3. ETO JUNYA (JPN)
3. SRITI MEHDI (MAR)
5. MARTINA MICHELE (ITA)
5. FIORE MATTEO (ITA)
7. ACEVEDO JOSE (ECU)
7. DIOP MAKHTAR (SEN)

*Seeded

Referees:			

Male Kumite -84 Kg - Round Robin (each against each)

Karate1 Premier League - Paris 2025, Pierre de Coubertin Stadium, Avenue George Lafont 82, 75016 Paris, FRA

Tatami

Pool
8/8



1	(*13) VASADZE L. (GEO)	#636 / 25.01	4	(*13) VASADZE L. (GEO)
2	(*32) KULOVIORI B. (FIN)		0	
3	(*8) TIMMERMANS B. (NED)	#637 / 25.01	0	(*1) ALJAFARI M. (JOR)
4	(*1) ALJAFARI M. (JOR)		3	
5	(*32) KULOVIORI B. (FIN)	#640 / 25.01	1	(*8) TIMMERMANS B. (NED)
6	(*8) TIMMERMANS B. (NED)		3	
7	(*13) VASADZE L. (GEO)	#641 / 25.01	0	(*1) ALJAFARI M. (JOR)
8	(*1) ALJAFARI M. (JOR)		9	
9	(*13) VASADZE L. (GEO)	#644 / 25.01	0	(*8) TIMMERMANS B. (NED)
10	(*8) TIMMERMANS B. (NED)		0	
11	(*32) KULOVIORI B. (FIN)	#645 / 25.01	0	(*1) ALJAFARI M. (JOR)
12	(*1) ALJAFARI M. (JOR)		9	

1. ALJAFARI MOHAMMAD (JOR)
2. TIMMERMANS BRIAN (NED)
3. VASADZE LUKA (GEO)
4. KULOVIORI BJORN (FIN)

1. BADAWY YOUSSEF (EGY)
2. ALJAFARI MOHAMMAD (JOR)
3. ETO JUNYA (JPN)
3. SRITI MEHDI (MAR)
5. MARTINA MICHELE (ITA)
5. FIORE MATTEO (ITA)
7. ACEVEDO JOSE (ECU)
7. DIOP MAKHTAR (SEN)

*Seeded

Referees:			

Pool winner-Male Kumite -84 Kg

Karate1 Premier League - Paris 2025, Pierre de Coubertin Stadium, Avenue George Lafont 82, 75016 Paris, FRA

Tatami

Pool
1/1

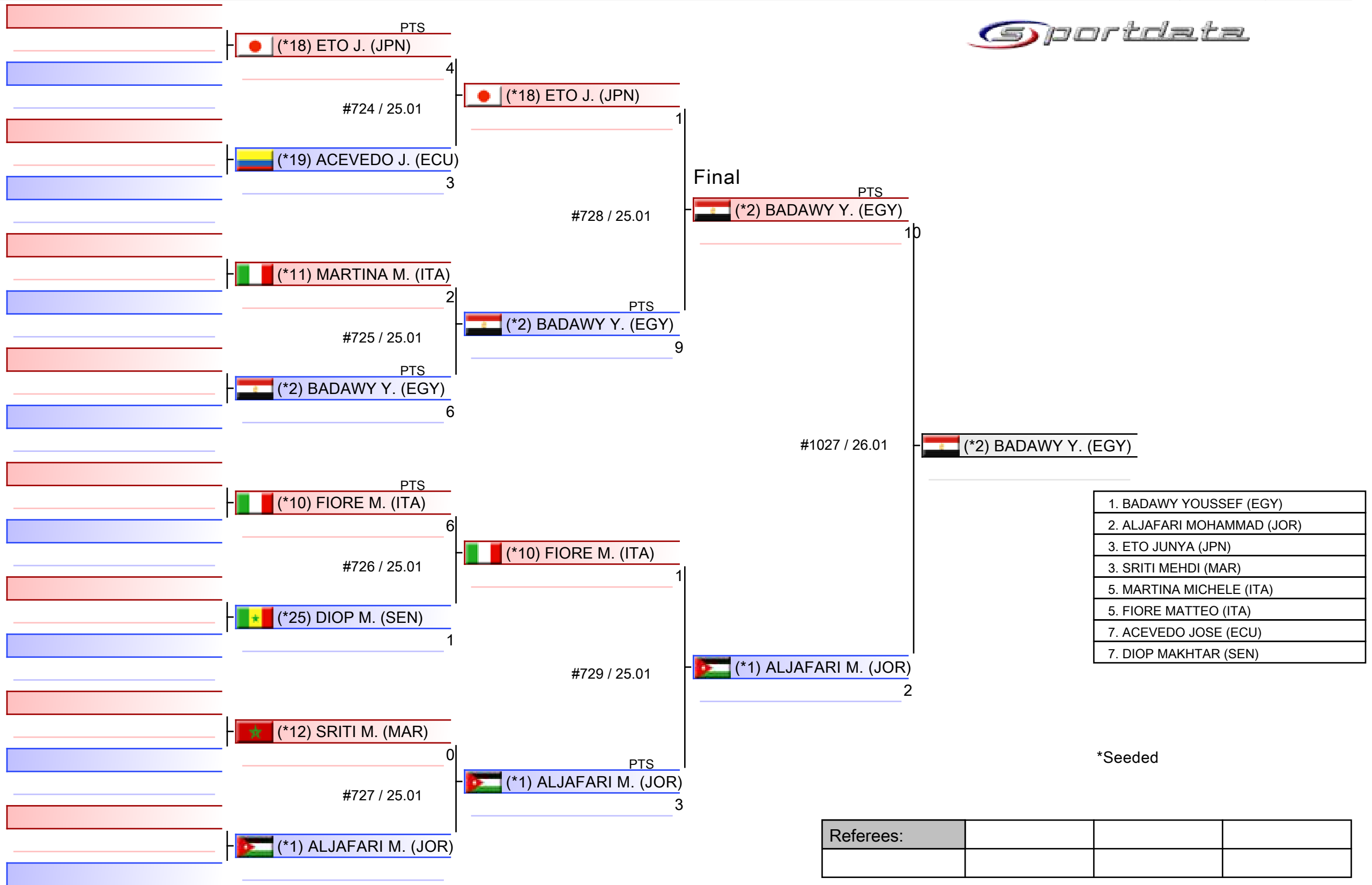

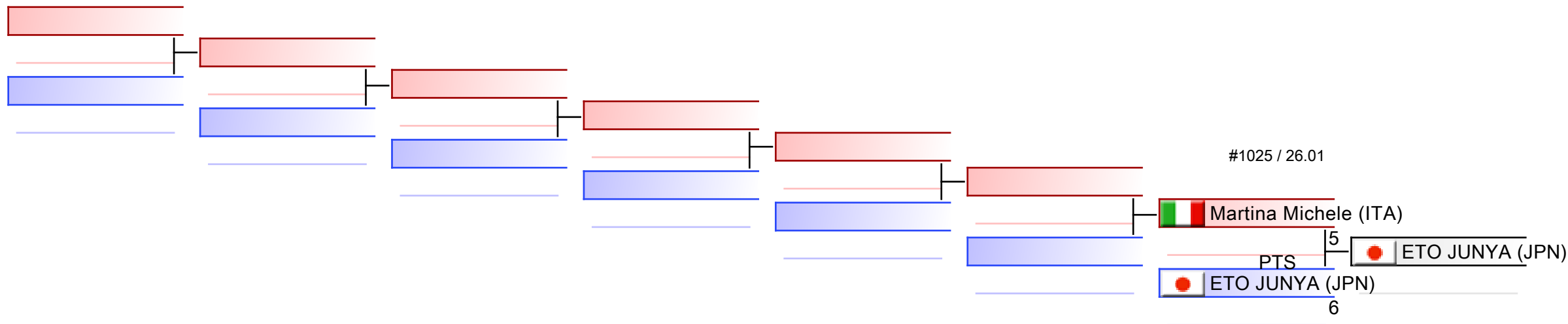

REPECHAGE: (1,2,3,4,5,6,7,8)

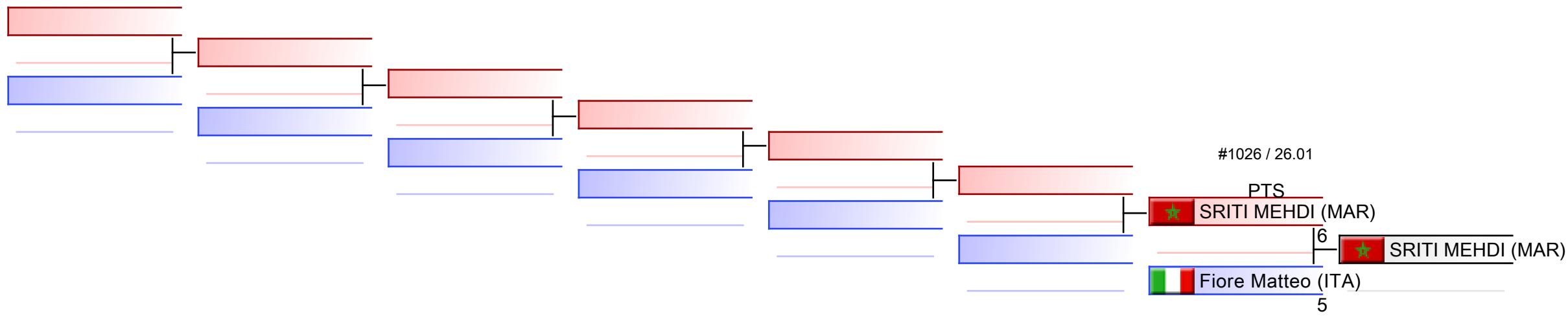

Referees:							
-----------	--	--	--	--	--	--	--

MALE KUMITE 84+ KG



Karate1 Premier League - Paris 2025

ENTRIES BY WEIGHT CATEGORY



Male Kumite 84+ Kg

As of 27 JAN 2025

Country Code	ID	Gender	Name	Seeding
ALG	ALG2163	M	Daikhi Hocine	10
AUS	AUS264	M	TIELEN DANIEL	25
BIH	BIH2179	M	BOSTANDZIC ANES	2
CHI	CHI139	M	ROJAS RODRIGO	12
CRO	CRO2872	M	GONDI NIKOLA	26
CRO	CRO367	M	KVESIC ANDJELO	4
CUR	CUR2120	M	Timmermans Rob	7
CZE	CZE2153	M	BOSAK ONDREJ	24
EGY	EGY383	M	Elmasry Ahmed	18
EGY	EGY2205	M	MAHMOUD TAHA TAREK	1
EGY	EGY2544	M	Mohamed Hazem	22
FRA	FRA2077	M	Filali Mehdi	6
FRA	FRA02870	M	ZOUAOUI AMIR	16
GEO	GEO02419	M	GELASHVILI MERABI	17
GER	GER03153	M	SEKOT NIKOLAI	15
IRI	IRI2024	M	ABAZARI SALEH	3
IRI	SD69128	M	ASHOURI GARMJANI MAHDI	20
IRI	IRI195	M	GANJZADEH SAJAD	27
ITA	ITA02948	M	AVANZINI matteo	8
ITA	ITA2796	M	GHISLANDI MICHAEL	30
ITA	ITA396	M	marino simone	29
JPN	JPN02706	M	Yoshimura Fumiya	14
KAZ	KAZ2300	M	ANARBEOV DIAS	13
NED	NED2271	M	Najdi Issam	28
SRB	SRB526	M	Tesanovic Djordje	21
TUN	TUN2275	M	CHOIYA HOUSSEM EDIN	9
TUR	TUR04289	M	GUNDOG UMUT EREN	19
TUR	TUR802	M	KAYALI FURKAN	23
UKR	UKR2020	M	TALIBOV RYZVAN	5
USA	USA03000	M	SAGILYAN EDUARD	11

Male Kumite 84+ Kg - Round Robin (each against each)

Karate1 Premier League - Paris 2025, Pierre de Coubertin Stadium, Avenue George Lafont 82, 75016 Paris, FRA

Tatami

Pool
1/8



1	(*19) GUNDOG U. (TUR)	#448 / 25.01	4	(*19) GUNDOG U. (TUR)
2	(*30) GHISLANDI M. (ITA)		0	
3	(*7) TIMMERMANS R. (CUR)	#449 / 25.01	1	
4	(*22) MOHAMED H. (EGY)		1	
5	(*30) GHISLANDI M. (ITA)	#452 / 25.01	0	(*7) TIMMERMANS R. (CUR)
6	(*7) TIMMERMANS R. (CUR)		5	
7	(*19) GUNDOG U. (TUR)	#453 / 25.01	0	(*22) MOHAMED H. (EGY)
8	(*22) MOHAMED H. (EGY)		1	
9	(*19) GUNDOG U. (TUR)	#456 / 25.01	0	(*7) TIMMERMANS R. (CUR)
10	(*7) TIMMERMANS R. (CUR)		5	
11	(*30) GHISLANDI M. (ITA)	#457 / 25.01	2	(*22) MOHAMED H. (EGY)
12	(*22) MOHAMED H. (EGY)		9	

1. TIMMERMANS ROB (CUR)
2. MOHAMED HAZEM (EGY)
3. GUNDOG UMUT EREN (TUR)
4. GHISLANDI MICHAEL (ITA)

1. MAHMOUD TAHA TAREK (EGY)
2. BOSTANDZIC ANES (BIH)
3. ANARBEKOV DIAS (KAZ)
3. TIMMERMANS ROB (CUR)
5. CHOIYA HOUSSEM EDIN (TUN)
5. SAGILYAN EDUARD (USA)
7. YOSHIMURA FUMIYA (JPN)
7. AVANZINI MATTEO (ITA)

*Seeded

Referees:			

Male Kumite 84+ Kg - Round Robin (each against each)

Karate1 Premier League - Paris 2025, Pierre de Coubertin Stadium, Avenue George Lafont 82, 75016 Paris, FRA

Tatami

Pool
2/8



PTS	Rank	Name	PTS
5	1	(*10) DAIKHI H. (ALG)	5
0	2	(*25) TIELEN D. (AUS)	0
1	3	(*14) YOSHIMURA F. (JPN)	1
0	4	(*3) ABAZARI S. (IRI)	0
2	5	(*25) TIELEN D. (AUS)	2
7	6	(*14) YOSHIMURA F. (JPN)	7
0	7	(*10) DAIKHI H. (ALG)	0
3	8	(*3) ABAZARI S. (IRI)	3
0	9	(*10) DAIKHI H. (ALG)	0
4	10	(*14) YOSHIMURA F. (JPN)	4
0	11	(*25) TIELEN D. (AUS)	0
0	12	(*3) ABAZARI S. (IRI)	0

1. YOSHIMURA FUMIYA (JPN)
2. ABAZARI SALEH (IRI)
3. DAIKHI HOCINE (ALG)
4. TIELEN DANIEL (AUS)

1. MAHMOUD TAHA TAREK (EGY)
2. BOSTANDZIC ANES (BIH)
3. ANARBEKOV DIAS (KAZ)
3. TIMMERMANS ROB (CUR)
5. CHOIYA HOUSSEM EDIN (TUN)
5. SAGILYAN EDUARD (USA)
7. YOSHIMURA FUMIYA (JPN)
7. AVANZINI MATTEO (ITA)

*Seeded

Referees:			

Male Kumite 84+ Kg - Round Robin (each against each)

Karate1 Premier League - Paris 2025, Pierre de Coubertin Stadium, Avenue George Lafont 82, 75016 Paris, FRA

Tatami

Pool
3/8



1. CHOIYA HOUSSEM EDIN (TUN)
2. MARINO SIMONE (ITA)
3. GANJZADEH SAJAD (IRI)
4. KAYALI FURKAN (TUR)

1. MAHMOUD TAHA TAREK (EGY)
2. BOSTANDZIC ANES (BIH)
3. ANARBEKOV DIAS (KAZ)
3. TIMMERMANS ROB (CUR)
5. CHOIYA HOUSSEM EDIN (TUN)
5. SAGILYAN EDUARD (USA)
7. YOSHIMURA FUMIYA (JPN)
7. AVANZINI MATTEO (ITA)

*Seeded

Referees:			

Male Kumite 84+ Kg - Round Robin (each against each)

Karate1 Premier League - Paris 2025, Pierre de Coubertin Stadium, Avenue George Lafont 82, 75016 Paris, FRA

Tatami

Pool
4/8



1	(*16) ZOUAOUI A. (FRA)	#522 / 25.01	5	(*16) ZOUAOUI A. (FRA)
2	(*26) GONDI N. (CRO)		5	
3	(*16) ZOUAOUI A. (FRA)	#528 / 25.01	1	(*2) BOSTANDZIC A. (BIH)
4	(*2) BOSTANDZIC A. (BIH)		9	
5	(*26) GONDI N. (CRO)	#525 / 25.01	1	(*2) BOSTANDZIC A. (BIH)
6	(*2) BOSTANDZIC A. (BIH)		7	

1. BOSTANDZIC ANES (BIH)
2. ZOUAOUI AMIR (FRA)
3. GONDI NIKOLA (CRO)

1. MAHMOUD TAHA TAREK (EGY)
2. BOSTANDZIC ANES (BIH)
3. ANARBEKOV DIAS (KAZ)
3. TIMMERMANS ROB (CUR)
5. CHOIYA HOUSSEM EDIN (TUN)
5. SAGILYAN EDUARD (USA)
7. YOSHIMURA FUMIYA (JPN)
7. AVANZINI MATTEO (ITA)

*Seeded

Referees:			

Male Kumite 84+ Kg - Round Robin (each against each)

Karate1 Premier League - Paris 2025, Pierre de Coubertin Stadium, Avenue George Lafont 82, 75016 Paris, FRA

Tatami

Pool
5/8

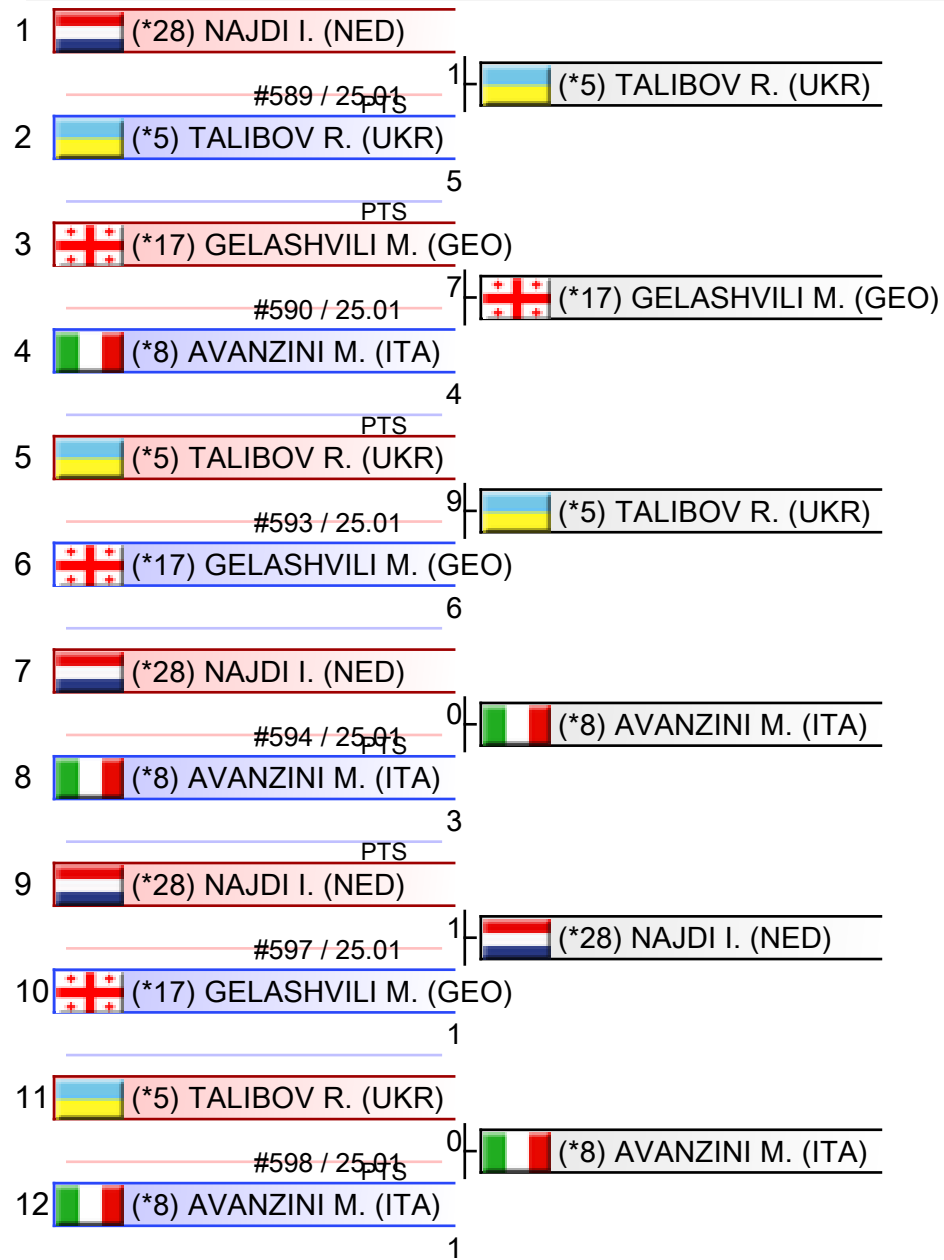

1. AVANZINI MATTEO (ITA)
2. TALIBOV RYZVAN (UKR)
3. NAJDI ISSAM (NED)
4. GELASHVILI MERABI (GEO)

1. MAHMOUD TAHA TAREK (EGY)
2. BOSTANDZIC ANES (BIH)
3. ANARBEKOV DIAS (KAZ)
3. TIMMERMANS ROB (CUR)
5. CHOIYA HOUSSEM EDIN (TUN)
5. SAGILYAN EDUARD (USA)
7. YOSHIMURA FUMIYA (JPN)
7. AVANZINI MATTEO (ITA)

*Seeded

Referees:			

Male Kumite 84+ Kg - Round Robin (each against each)

Karate1 Premier League - Paris 2025, Pierre de Coubertin Stadium, Avenue George Lafont 82, 75016 Paris, FRA

Tatami

Pool
6/8



1	(*18) ELMASRY A. (EGY)	#591 / 25.01	
2	(*11) SAGILYAN E. (USA)		
3	(*24) BOSAK O. (CZE)	#592 / 25.01	0
4	(*4) KVESIC A. (CRO)		2
5	(*11) SAGILYAN E. (USA)	#595 / 25.01	4
6	(*24) BOSAK O. (CZE)		0
7	(*18) ELMASRY A. (EGY)	#596 / 25.01	
8	(*4) KVESIC A. (CRO)		
9	(*18) ELMASRY A. (EGY)	#599 / 25.01	
10	(*24) BOSAK O. (CZE)		
11	(*11) SAGILYAN E. (USA)	#600 / 25.01	1
12	(*4) KVESIC A. (CRO)		0

1. SAGILYAN EDUARD (USA)
2. KVESIC ANDJELO (CRO)
3. BOSAK ONDREJ (CZE)
4. ELMASRY AHMED (EGY)

1. MAHMOUD TAHA TAREK (EGY)
2. BOSTANDZIC ANES (BIH)
3. ANARBEKOV DIAS (KAZ)
3. TIMMERMANS ROB (CUR)
5. CHOIYA HOUSSEM EDIN (TUN)
5. SAGILYAN EDUARD (USA)
7. YOSHIMURA FUMIYA (JPN)
7. AVANZINI MATTEO (ITA)

*Seeded

Referees:			

Male Kumite 84+ Kg - Round Robin (each against each)

Karate1 Premier League - Paris 2025, Pierre de Coubertin Stadium, Avenue George Lafont 82, 75016 Paris, FRA

Tatami

Pool
7/8



1	(*21) TESANOVIC D. (SRB)	#655 / 25.01	5	(*21) TESANOVIC D. (SRB)
2	(*15) SEKOT N. (GER)		3	
3	(*13) ANARBEKOV D. (KAZ)	#656 / 25.01	2	(*20) ASHOURI GARMJANI M. (IRI)
4	(*20) ASHOURI GARMJANI M. (IRI)		9	
5	(*15) SEKOT N. (GER)	#658 / 25.01	0	(*13) ANARBEKOV D. (KAZ)
6	(*13) ANARBEKOV D. (KAZ)		1	
7	(*21) TESANOVIC D. (SRB)	#659 / 25.01	0	
8	(*20) ASHOURI GARMJANI M. (IRI)		0	
9	(*21) TESANOVIC D. (SRB)	#661 / 25.01	3	(*13) ANARBEKOV D. (KAZ)
10	(*13) ANARBEKOV D. (KAZ)		7	
11	(*15) SEKOT N. (GER)	#662 / 25.01	4	(*15) SEKOT N. (GER)
12	(*20) ASHOURI GARMJANI M. (IRI)		3	

1. ANARBEKOV DIAS (KAZ)
2. ASHOURI GARMJANI MAHDI (IRI)
3. TESANOVIC DJORDJE (SRB)
4. SEKOT NIKOLAI (GER)

1. MAHMOUD TAHA TAREK (EGY)
2. BOSTANDZIC ANES (BIH)
3. ANARBEKOV DIAS (KAZ)
3. TIMMERMANS ROB (CUR)
5. CHOIYA HOUSSEM EDIN (TUN)
5. SAGILYAN EDUARD (USA)
7. YOSHIMURA FUMIYA (JPN)
7. AVANZINI MATTEO (ITA)

*Seeded

Referees:			

Male Kumite 84+ Kg - Round Robin (each against each)

Karate1 Premier League - Paris 2025, Pierre de Coubertin Stadium, Avenue George Lafont 82, 75016 Paris, FRA

Tatami

Pool
8/8

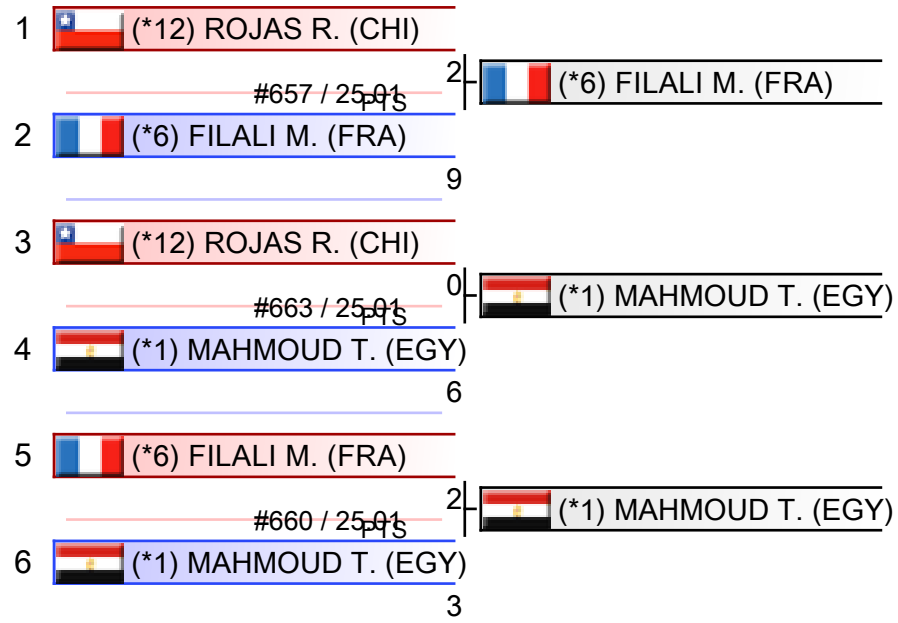

1. MAHMOUD TAHA TAREK (EGY)
2. FILALI MEHDI (FRA)
3. ROJAS RODRIGO (CHI)

1. MAHMOUD TAHA TAREK (EGY)
2. BOSTANDZIC ANES (BIH)
3. ANARBEKOV DIAS (KAZ)
3. TIMMERMANS ROB (CUR)
5. CHOIYA HOUSSEM EDIN (TUN)
5. SAGILYAN EDUARD (USA)
7. YOSHIMURA FUMIYA (JPN)
7. AVANZINI MATTEO (ITA)

*Seeded

Referees:			

Pool winner-Male Kumite 84+ Kg

Karate1 Premier League - Paris 2025, Pierre de Coubertin Stadium, Avenue George Lafont 82, 75016 Paris, FRA

Tatami

Pool
1/1

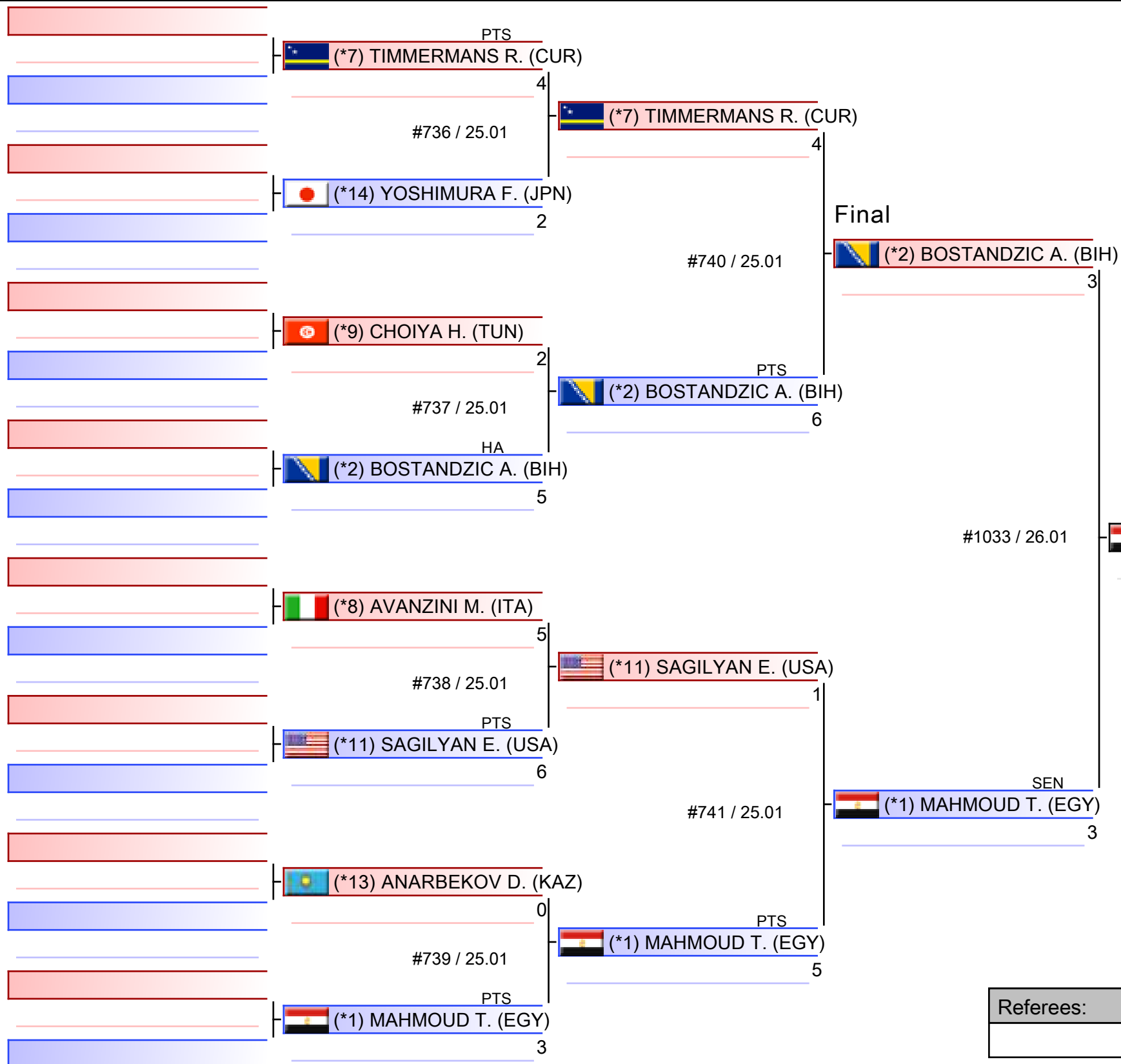

1. MAHMOUD TAHA TAREK (EGY)
2. BOSTANDZIC ANES (BIH)
3. ANARBEKOV DIAS (KAZ)
3. TIMMERMANS ROB (CUR)
5. CHOIYA HOUSSEM EDIN (TUN)
5. SAGILYAN EDUARD (USA)
7. YOSHIMURA FUMIYA (JPN)
7. AVANZINI MATTEO (ITA)

*Seeded

Referees:			

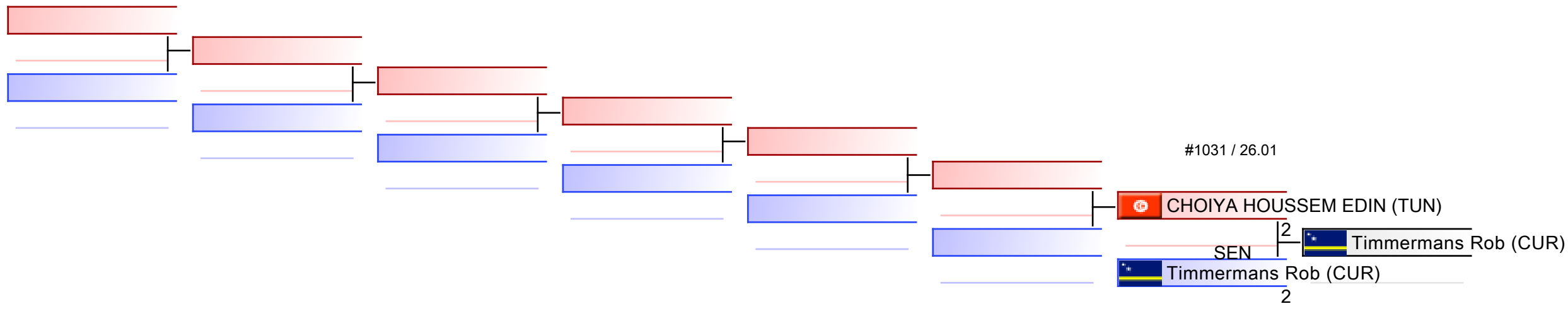

REPECHAGE: (1,2,3,4,5,6,7,8)

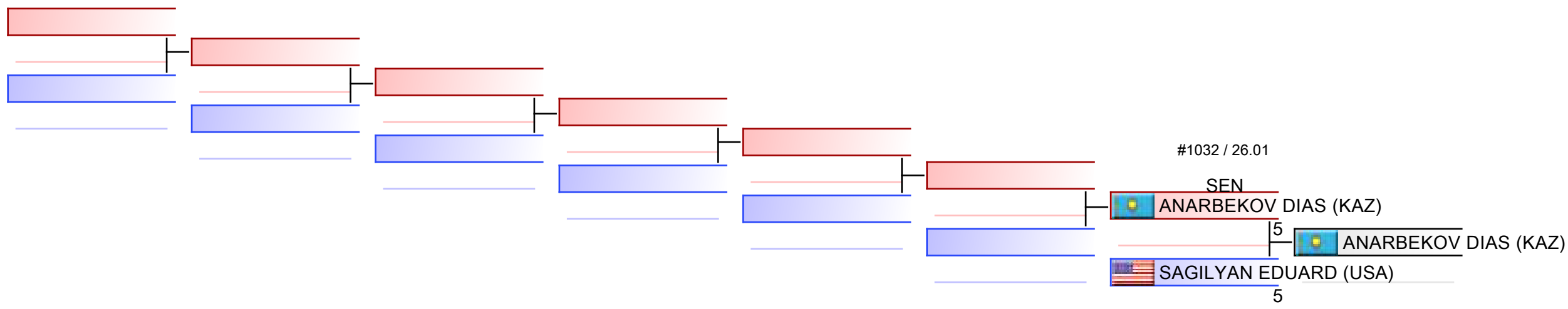

Referees:							
-----------	--	--	--	--	--	--	--



Official Results

Female Kata			
1	ONO MAHO		JPN - JAPAN
2	LAU MO SHEUNG GRACE		HKG - HONG KONG, CHINA
3	MISHIMA KIRI		JPN - JAPAN
3	AZUMA SAEKO		JPN - JAPAN
5	GARCIA LOZANO PAOLA		ESP - SPAIN
5	MISKOVA VERONIKA		CZE - CZECH REPUBLIC
7	SHIMIZU NATSUKI		JPN - JAPAN
7	KOKUMAI SAKURA		USA - UNITED STATES

Female Kumite -50 Kg			
1	BAHMANYAR SARA		IRI - ISLAMIC REPUBLIC OF IRAN
2	MOHSENIAN MASOUMEH		IRI - ISLAMIC REPUBLIC OF IRAN
3	ZHANGBYRBAY MOLDIR		KAZ - KAZAKHSTAN
3	SALAZAR YORGELIS		VEN - VENEZUELA
5	OKAZAKI AIKA		JPN - JAPAN
5	VARGOVA NATALIA		SVK - SLOVAKIA
7	IZAGUIRRE GABRIELLA		ESA - EL SALVADOR
7	CHANDRAN SHAHMALARANI		MAS - MALAYSIA

Female Kumite -55 Kg			
1	YOUSSEF AHLAM		EGY - EGYPT
2	FURUMOTO-DESHAIES HANA		CAN - CANADA
3	YAKAN TUBA		TUR - TURKIYE
3	ALLEN TRINITY		USA - UNITED STATES
5	STOLI MARIA		GRE - GREECE
5	KODO RINA		JPN - JAPAN
7	AGUNG SANISTYARANI COK ISTRI		INA - INDONESIA
7	GORANOVA IVET		BUL - BULGARIA

Female Kumite -61 Kg			
1	SHIMADA SARARA		JPN - JAPAN
2	KANAY ASSEL		KAZ - KAZAKHSTAN
3	GIRVICA BEATA		LAT - LATVIA
3	YVON SYDNEY		FRA - FRANCE
5	AVAZERI LEA		FRA - FRANCE
5	KAKIAY ASHLEY		NED - NETHERLANDS
7	RADJENOVIC NINA		SUI - SWITZERLAND
7	NILSSON ANNA-JOHANNA		SWE - SWEDEN

Female Kumite -68 Kg			
1	SOMBE THALYA		FRA - FRANCE
2	KAMA TSUBASA		JPN - JAPAN
3	QUIRICI ELENA		SUI - SWITZERLAND
3	ELTEMUR EDA		TUR - TURKIYE
5	Nieto Mejias Maria Isabel		ESP - SPAIN



Official Results

5	FONSECA ROMERO JANESSA MICHELLE		PUR - PUERTO RICO	
7	HENDY HADIR		EGY - EGYPT	
7	BECIROVIC SADEA		CRO - CROATIA	

Female Kumite 68+ Kg

1	TORRES GARCIA MARIA		ESP - SPAIN	
2	BERULTSEVA SOFYA		KAZ - KAZAKHSTAN	
3	WALTERS ROCHELLE		ENG - ENGLAND	
3	EDDARHRI MAROUA		MAR - MOROCCO	
5	KNEER JOHANNA		GER - GERMANY	
5	CREEMERS INGRID		NED - NETHERLANDS	
7	DANISZEWSKA JULIA		POL - POLAND	
7	FERRACUTI CLIO		ITA - ITALY	

Male Kata

1	NISHIYAMA KAKERU		JPN - JAPAN	
2	MACHIDA YASUHIRO		JPN - JAPAN	
3	MOTO KAZUMASA		JPN - JAPAN	
3	TORRES GUTIERREZ ARIEL		USA - UNITED STATES	
5	KIKUCHI RYONOSUKE		JPN - JAPAN	
5	TOZAKI GAKUJI		USA - UNITED STATES	
7	MOTO RYUJI		JPN - JAPAN	
7	GHINAMI ALESSIO		ITA - ITALY	

Male Kumite -60 Kg

1	SAMDAN ERAY		TUR - TURKIYE	
2	XENOS CHRISTOS-STEFANOS		GRE - GREECE	
3	ALPYSBAY KAISAR		KAZ - KAZAKHSTAN	
3	MESKINI ALI		IRI - ISLAMIC REPUBLIC OF IRAN	
5	ARIFI ORGES		ALB - ALBANIA	
5	HASHIMOTO HIROMU		JPN - JAPAN	
7	ALY ZYAD		EGY - EGYPT	
7	TAS SAMI		FRA - FRANCE	

Male Kumite -67 Kg

1	KOZAKI YUGO		JPN - JAPAN	
2	OZER OMER ABDURRAHIM		TUR - TURKIYE	
3	FIGUEIRA VINICIUS		BRA - BRAZIL	
3	BALLOTIS GEORGIOS		GRE - GREECE	
5	DE VIVO GIANLUCA		ITA - ITALY	
5	RZAZADE NURAN		AZE - AZERBAIJAN	
7	YANOVSKYI DAVYD		UKR - UKRAINE	
7	MARESCA LUCA		ITA - ITALY	

Male Kumite -75 Kg

1	ABDELAZIZ ABDALLA		EGY - EGYPT	
2	MIKULIC NEMANJA		MNE - MONTENEGRO	



Official Results

3	RAHOZENKO ERIK		UKR - UKRAINE	
3	ABDELGAWAD ABDALLA HESHAM		EGY - EGYPT	
5	ABUDABOUS MOHAMED		LBA - LIBYA	
5	PITSUL HEORHII		UKR - UKRAINE	
7	BERTHON ENZO		FRA - FRANCE	
7	SAKIYAMA YUSEI		JPN - JAPAN	

Male Kumite -84 Kg

1	BADAWY YOUSSEF		EGY - EGYPT	
2	ALJAFARI MOHAMMAD		JOR - JORDAN	
3	ETO JUNYA		JPN - JAPAN	
3	SRITI MEHDI		MAR - MOROCCO	
5	MARTINA MICHELE		ITA - ITALY	
5	FIORE MATTEO		ITA - ITALY	
7	ACEVEDO JOSE		ECU - ECUADOR	
7	DIOP MAKHTAR		SEN - SENEGAL	

Male Kumite 84+ Kg

1	MAHMOUD TAHA TAREK		EGY - EGYPT	
2	BOSTANDZIC ANES		BIH - BOSNIA AND HERZEGOVINA	
3	ANARBEKOV DIAS		KAZ - KAZAKHSTAN	
3	TIMMERMANS ROB		CUR - CURACAO	
5	CHOIYA HOUSSEM EDIN		TUN - TUNISIA	
5	SAGILYAN EDUARD		USA - UNITED STATES	
7	YOSHIMURA FUMIYA		JPN - JAPAN	
7	AVANZINI MATTEO		ITA - ITALY	